

FORWELL™

印刷電路板沖孔油壓脫料系統
PCB FINE PIERCING SYSTEM

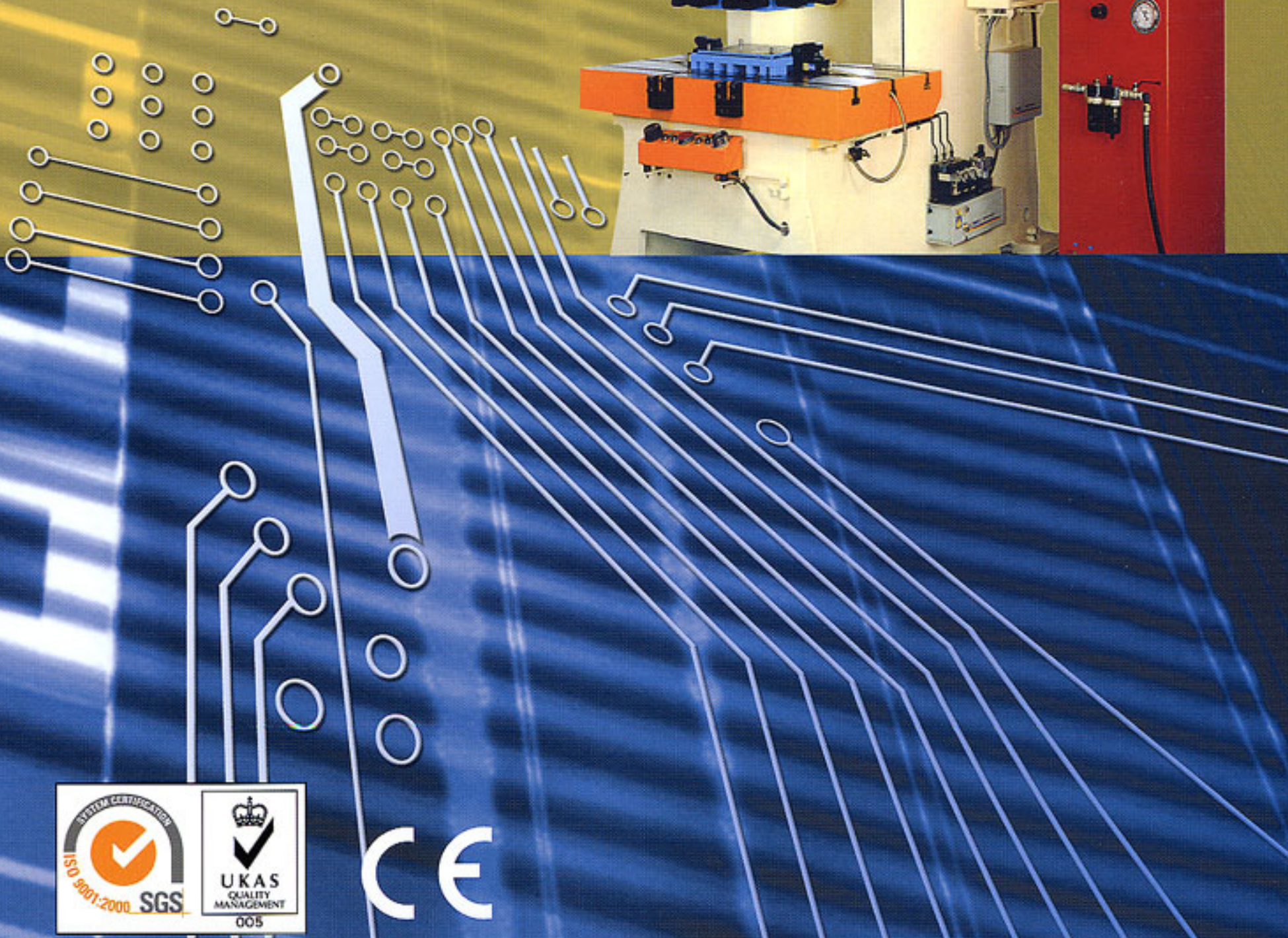
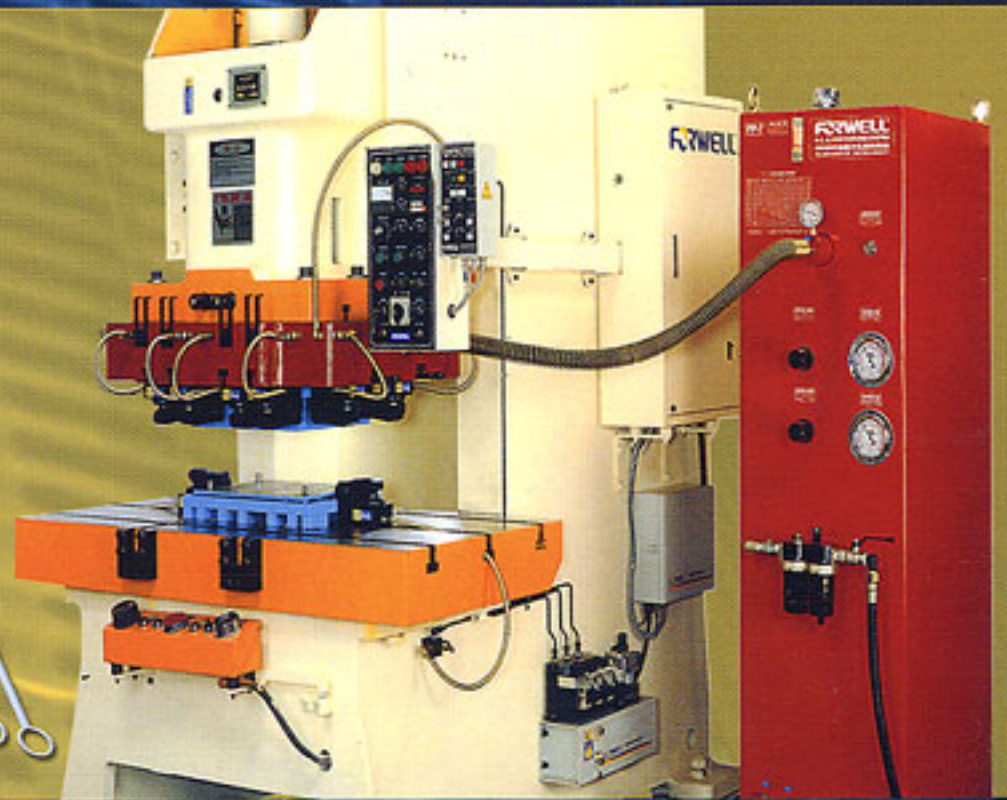

CE

高品質印刷電路板之要素 / ESSENTIAL TOOL FOR HIGH QUALITY PCBs.

富偉印刷電路板沖孔油壓脫料系統，乃是空氣壓轉換為油壓動力源組合，沖孔脫料台盤組合及快速換模系統等所組成，而沖孔前壓板壓力及沖孔後油壓平均脫料之動作及出力可依不同材質來調整，以達到業界追求高品質的要求。

FORWELL PCB Fine Piercing System is a combination of hydraulic power unit which charged by air pressure, a piercing plate and a quick die change system. Easy set hold down and stripping pressure to reach excellent quality.

特點：

- 操作及調整容易。
- 精確度高，安全又耐用。
- 適合任何電路板之沖孔脫料作業。
- 配備快速換模系統，提高生產效率。
- 達到自動化、省力化、提高加工品質的要求。

FEATURES

- Easy operation and adjustment.
- Highly precise and durable.
- Suitable for the fine piercing of high-density PCBs.
- With quick die changing system, increases productivity.
- Automatic, labor-saving, and of excellent quality.

MODEL NO. & SPECIFICATIONS

Model	脫料能力 Stripping Force	壓板能力 Hold-down Force	適用沖床噸數 Press Tonnage
FP-2	35.0 tf Max.	16.0 tf Max.	60~80 TON
FP-2L			
FP-3	43.0 tf Max.	21.0 tf Max.	80~110 TON
FP-3L			
FP-5	45.0 tf Max.	24.0 tf Max.	110~150 TON
FP-5L			
FP-7	63.0 tf Max.	36.0 tf Max.	150~200 TON
FP-7L			
FP-8	100.0 tf Max.	50.0 tf Max.	200~350 TON
FP-8L			

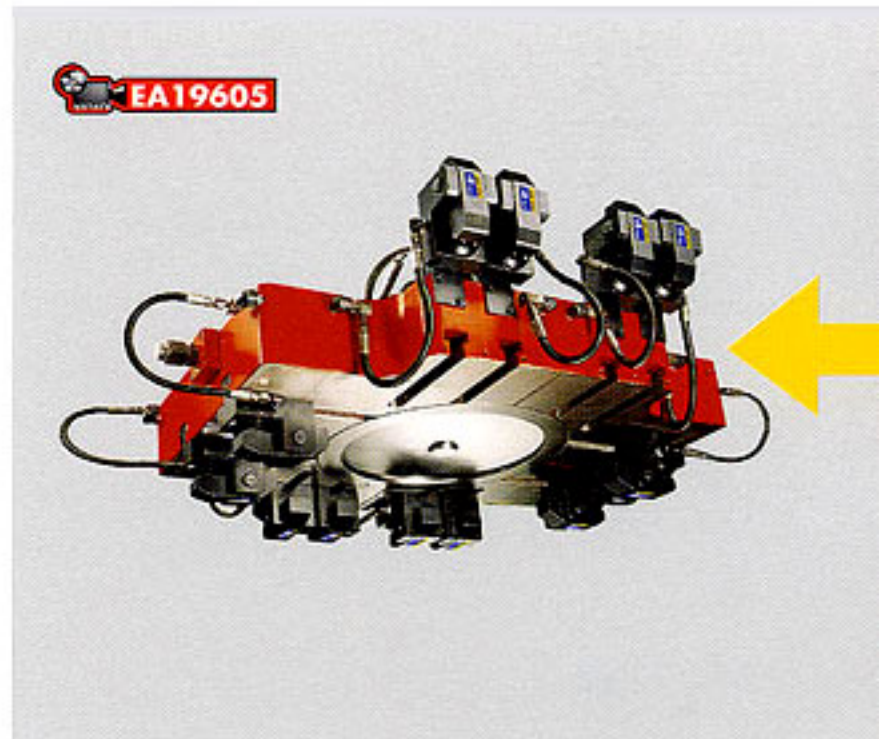

系統解說 / SYSTEM CONSTRUCTION

1. 脫料台盤組合 PIERCING PLATE UNIT

特殊設計結構，打板經精密加工及硬化處理，多層油封設計。動作滑順均勻，脫料出力平均。

Special device and structure, sample is processed by precision processing and hardened, mutiple seals device. Smoothly stripping and piercing.

2. 動力源組合 POWER UNIT

利用空氣壓力為動力產生油壓壓力，藉供給空氣壓力之調整產生不同脫料壓力，出力平均配合沖床沖孔速度。0度或180度之脫料可調整以配合送料自動化作業。

Use air pressure to charge hydraulic system. Easily set hold-down and stripping pressure, and select a stripping position on top (0°) or bottom (180°) by flicking the switch.

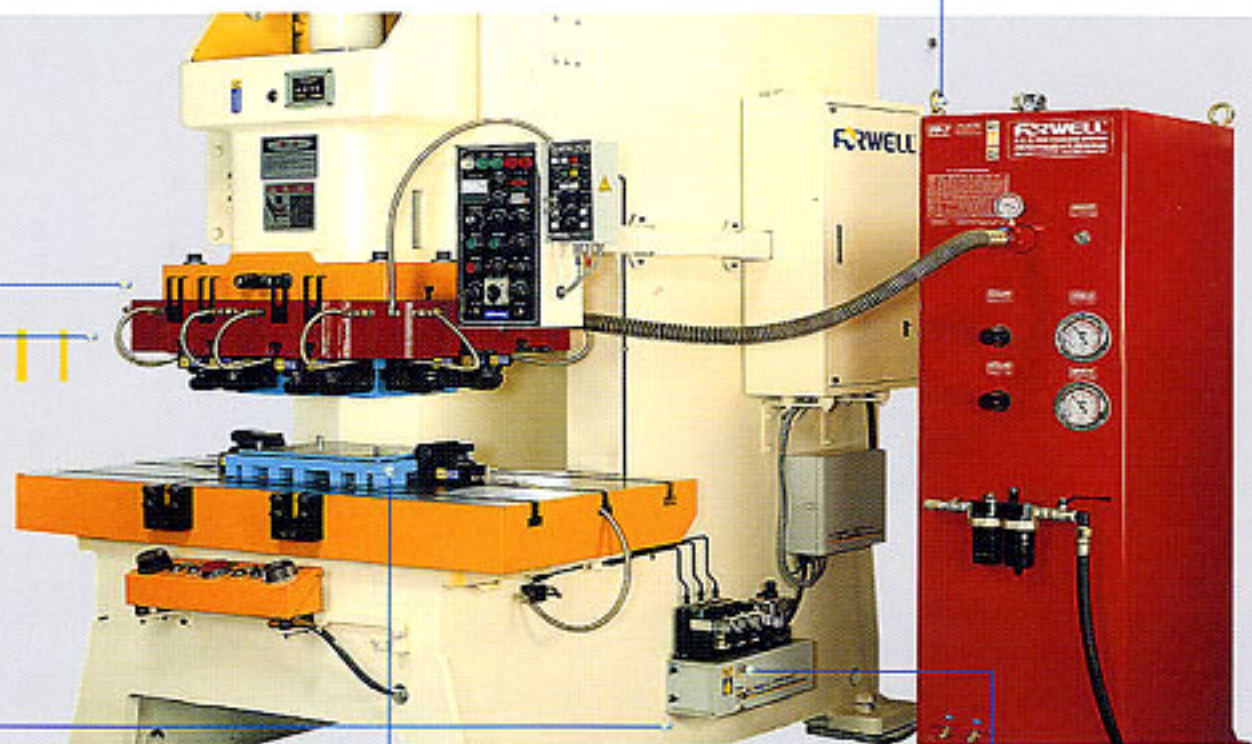

3. 快速換模系統 QUICK DIE CHANGE SYSTEM

配合脫料能力配備不同夾模器，使更換模具簡單快速。夾模器有效強力夾模，沖孔時模具不滑動。動力源採用氣動泵組合，隨時停電或空氣壓消失時，夾模能長時間保持，節省換模時間使作業更安全，提高生產效率。

To comply with different capacity of die clamp, easy and quick die changing. The die clamp can tightly hold the die, it is steady when piercing. Use air pump ensures a long time die-clamping even when there is a power failure or the air pressure disappears. Saving time on changing die, more safe and increase productivity.



TY夾模器
TY DIE CLAMP



氣動泵組合
PUMP UNITS

The way of viewing P.F.P.S. of FORWELL:

Please visit website www.machinesources.com and key in the video serial number

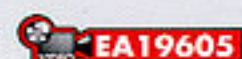

高品質沖孔油壓脫料作業之重點 / KEY TO HIGH QUALITY PIERCING

沖床機械是頂出脫料裝置 CONVENTIONAL METHOD

優力膠方式不可調整壓板壓力

WITHOUT HOLD-DOWN SYSTEM

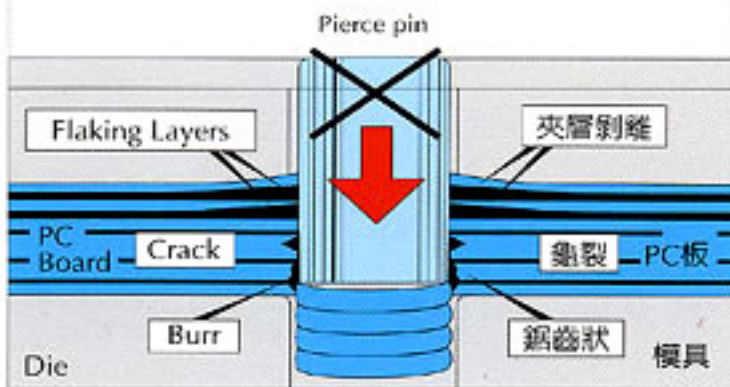

富偉沖孔油壓脫料系統 FORWELL FINE PIERCING SYSTEM

油壓方式可調整壓板壓力

EQUIPPED WITH HOLDER MECHANISM

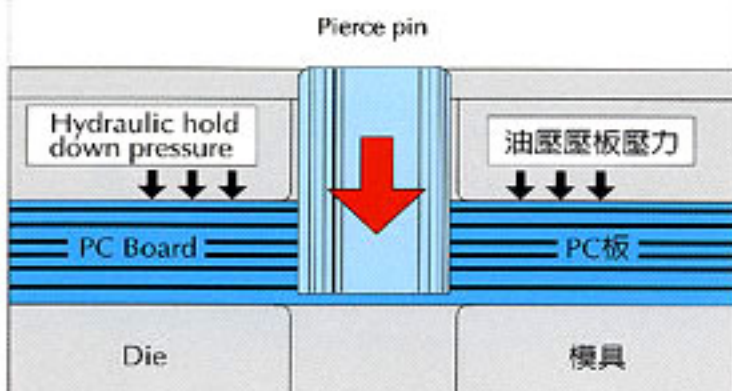

工作流程 WORKING FUNCTION & PROCESS

1. 壓板壓力工程 HOLD-DOWN

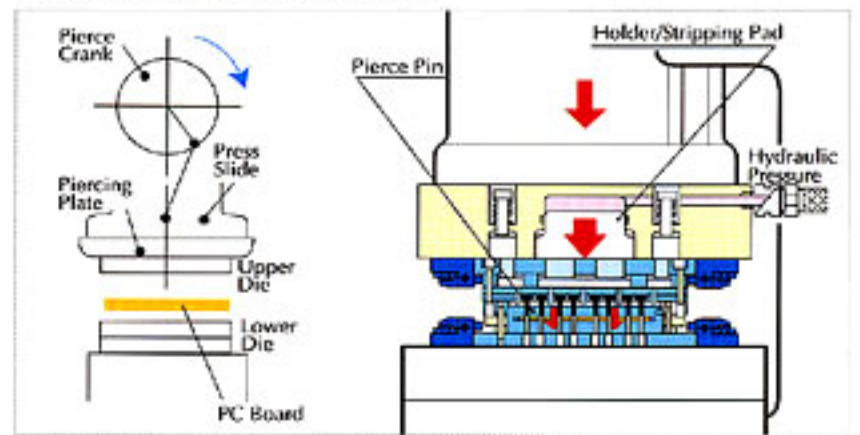

2. 沖孔工程 PIERCING

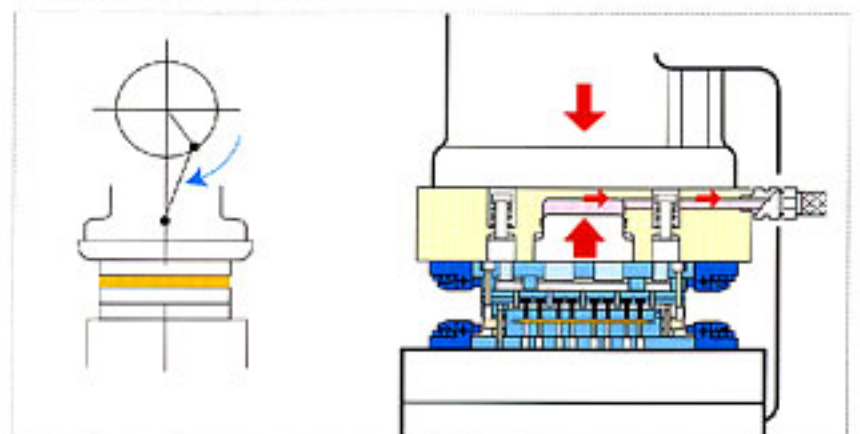

3. 沖孔完畢工程 HOLD PIERCING (Board Held on Upper Die)

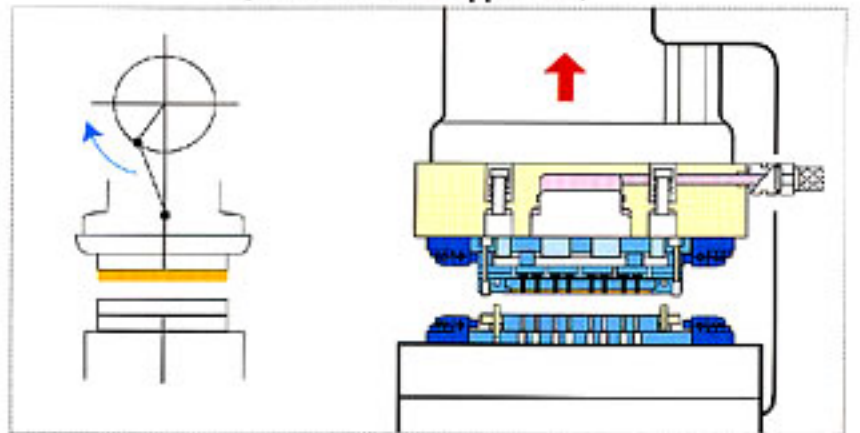

4. 脫料壓力工程 STRIPPING

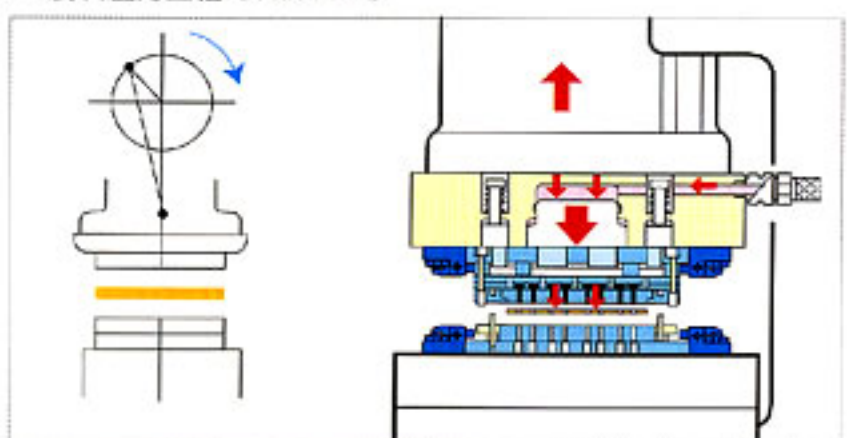

沖孔油壓脫料之特性 / FP PLATE SPECIFICATIONS

MODEL FP2 & SPECIFICATIONS

Model	FP2 SERIES
Stripping Capacity 脫料能力	Adjustable 35.0 tf Max.
Hold-down Capacity 壓板能力	Adjustable 16.0 tf Max.
Stripping Pad Stroke 打板行程	5mm
Press Tonnage 適用沖床	60-80 tf.
FP Plate Thickness 脫料台盤厚度	100mm
FP Plate Weight 脫料台盤重量	400kg
Upper Die Clamp 上模夾模器	TY- 4 / 8 PCS
Lower Die Clamp 下模夾模器	TY- 6 / 2 PCS
FORWELL die clamping system is provided as a standard accessory.	

使用空氣量：14N₂/shot

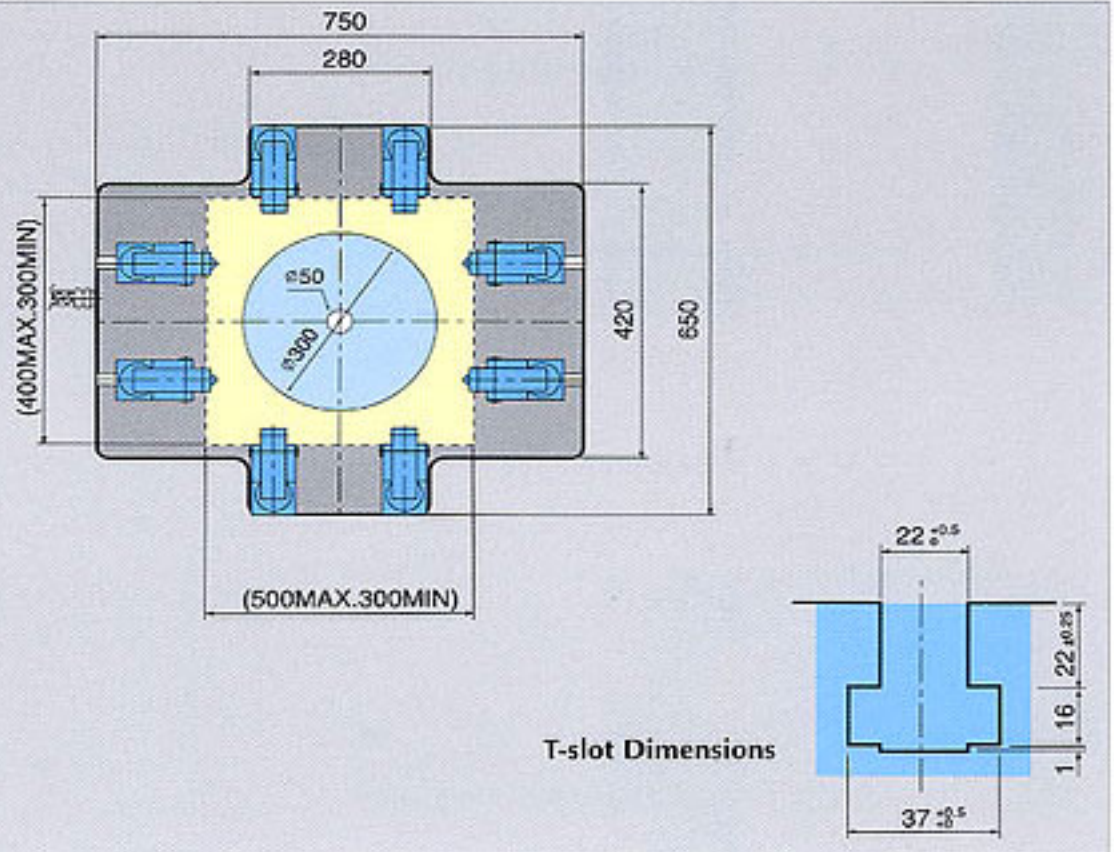

MODEL FP2L & SPECIFICATIONS

Model	FP2L SERIES
Stripping Capacity 脫料能力	Adjustable 35.0 tf Max.
Hold-down Capacity 壓板能力	Adjustable 16.0 tf Max.
Stripping Pad Stroke 打板行程	5mm
Press Tonnage 適用沖床	60-80 tf.
FP Plate Thickness 脫料台盤厚度	100mm
FP Plate Weight 脫料台盤重量	400kg
Upper Die Clamp 上模夾模器	TY - 4 / 8 PCS
Lower Die Clamp 下模夾模器	TY - 6 / 2 PCS
FORWELL die clamping system is provided as a standard accessory.	

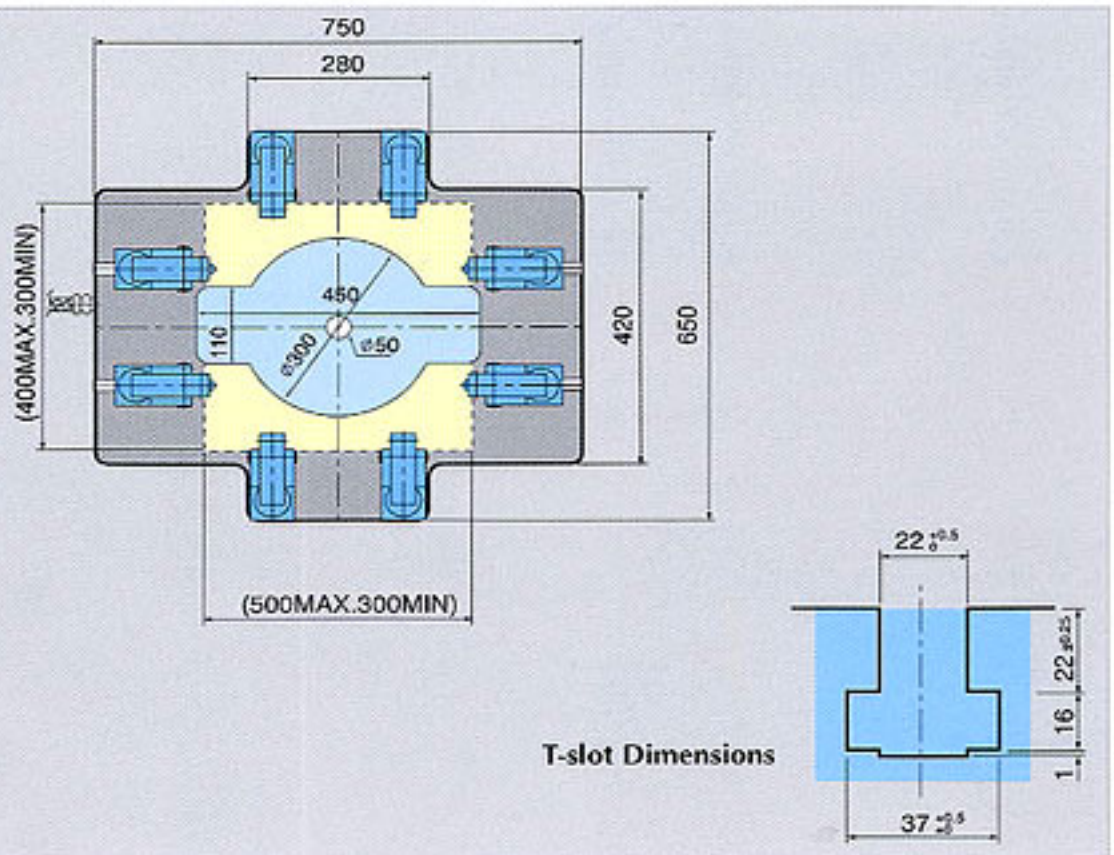

*註：品質不斷改良，尺寸變更不另行通知。
Due to the continuing innovations, product dimensions subject to change without further notice.

沖孔油壓脫料之特性 / FP PLATE SPECIFICATIONS

MODEL FP3 & SPECIFICATIONS

Model	FP3 SERIES
Stripping Capacity 脫料能力	Adjustable 43.0 tf Max.
Hold-down Capacity 壓板能力	Adjustable 21.0 tf Max.
Stripping Pad Stroke 打板行程	5mm
Press Tonnage 適用沖床	80-110 tf
FP Plate Thickness 脫料台盤厚度	110mm
FP Plate Weight 脫料台盤重量	500kg
Upper Die Clamp 上模夾模器	TY- 4 / 8 PCS
Lower Die Clamp 下模夾模器	TY- 6 / 2 PCS
FORWELL die clamping system is provided as a standard accessory.	

使用空氣量：23Nℓ / shot

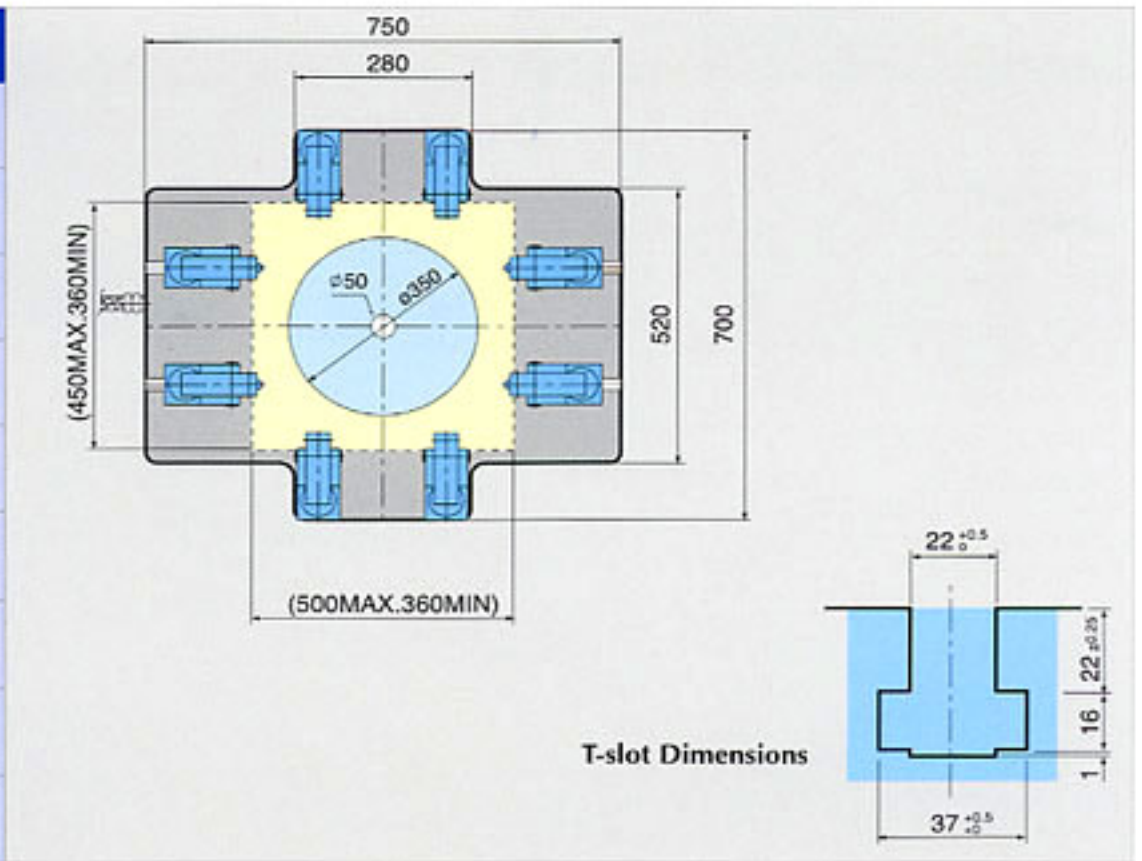

MODEL FP3L & SPECIFICATIONS

Model	FP3L SERIES
Stripping Capacity 脫料能力	Adjustable 43.0 tf Max.
Hold-down Capacity 壓板能力	Adjustable 21.0 tf Max.
Stripping Pad Stroke 打板行程	5mm
Press Tonnage 適用沖床	80-110 tf
FP Plate Thickness 脫料台盤厚度	110mm
FP Plate Weight 脫料台盤重量	500kg
Upper Die Clamp 上模夾模器	TY- 4 / 8 PCS
Lower Die Clamp 下模夾模器	TY- 6 / 2 PCS
FORWELL die clamping system is provided as a standard accessory.	

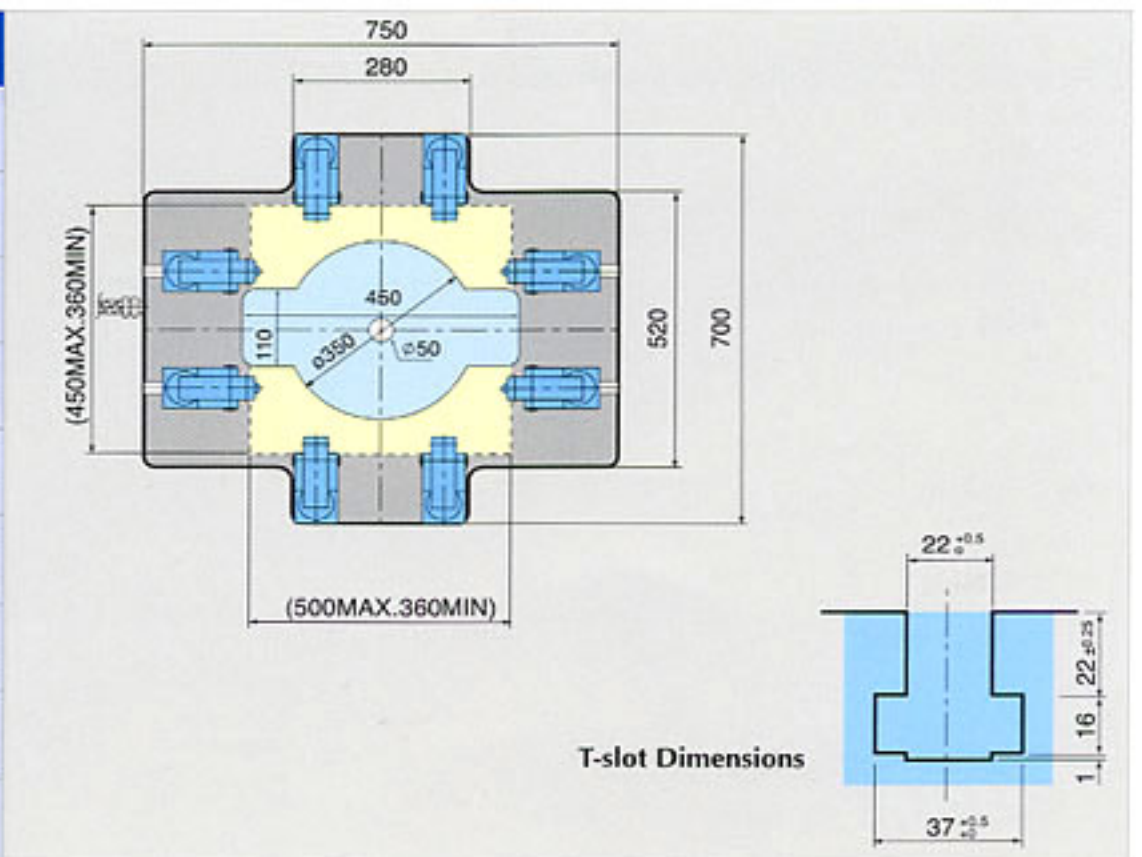

沖孔油壓脫料之特性 / FP PLATE SPECIFICATIONS

MODEL FP5 & SPECIFICATIONS

Model	FP5 SERIES
Stripping Capacity 脫料能力	Adjustable 45.0 tf Max.
Hold-down Capacity 壓板能力	Adjustable 24.0 tf Max.
Stripping Pad Stroke 打板行程	5mm
Press Tonnage 適用沖床	110-150 tf.
FP Plate Thickness 脫料台盤厚度	130mm
FP Plate Weight 脫料台盤重量	600kg
Upper Die Clamp 上模夾模器	TY- 4 / 12 PCS
Lower Die Clamp 下模夾模器	TY- 6 / 2 PCS
FORWELL die clamping system is provided as a standard accessory.	

使用空氣量：24N_l/shot

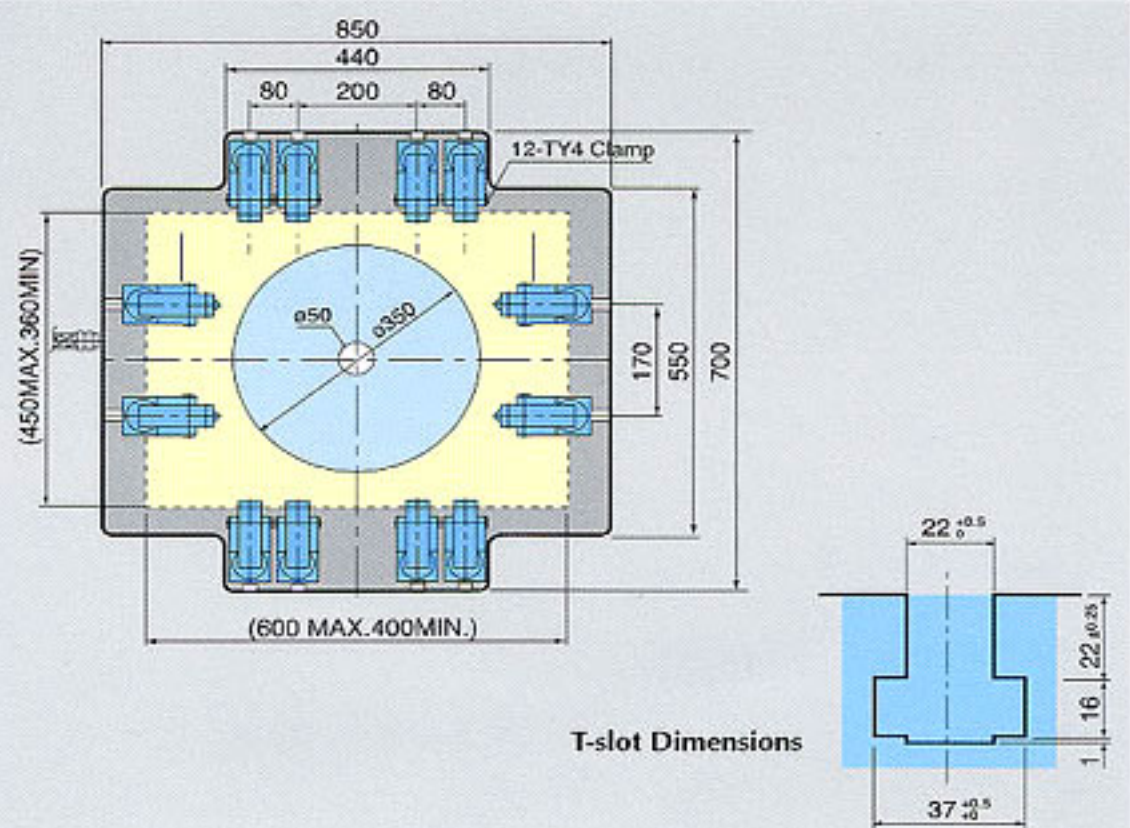

MODEL FP5L & SPECIFICATIONS

Model	FP5L SERIES
Stripping Capacity 脫料能力	Adjustable 45.0 tf Max.
Hold-down Capacity 壓板能力	Adjustable 24.0 tf Max.
Stripping Pad Stroke 打板行程	5mm
Press Tonnage 適用沖床	110-150 tf.
FP Plate Thickness 脫料台盤厚度	130mm
FP Plate Weight 脫料台盤重量	600kg
Upper Die Clamp 上模夾模器	TY- 4 / 12 PCS
Lower Die Clamp 下模夾模器	TY- 6 / 2 PCS
FORWELL die clamping system is provided as a standard accessory.	

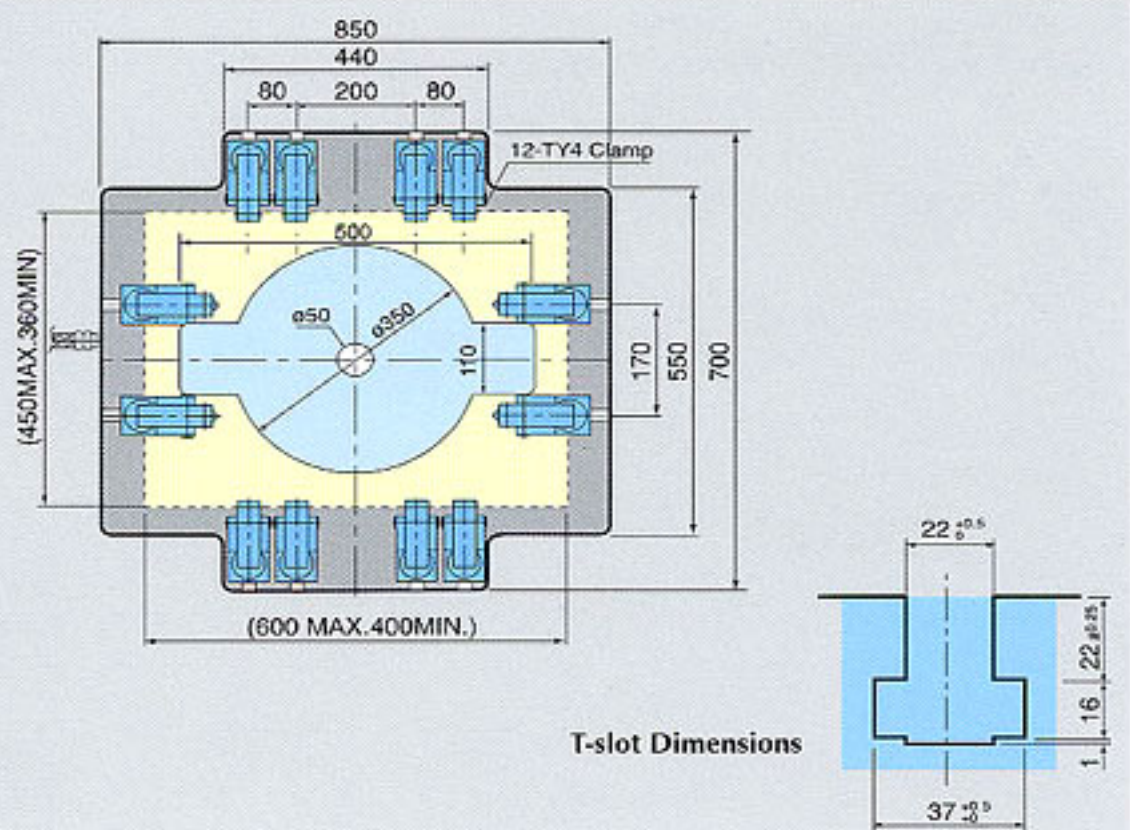

沖孔油壓脫料之特性 / FP PLATE SPECIFICATIONS

MODEL FP7 & SPECIFICATIONS

Model	FP7 SERIES
Stripping Capacity 脫料能力	Adjustable 63.0 tf Max.
Hold-down Capacity 壓板能力	Adjustable 36.0 tf Max.
Stripping Pad Stroke 打板行程	5mm
Press Tonnage 適用沖床	150-200 tf.
FP Plate Thickness 脫料台盤厚度	148mm
FP Plate Weight 脫料台盤重量	800kg
Upper Die Clamp 上模夾模器	TY- 6 / 12 PCS
Lower Die Clamp 下模夾模器	TY- 10 / 2 PCS
FORWELL die clamping system is provided as a standard accessory.	

使用空氣量：42N_c/shot

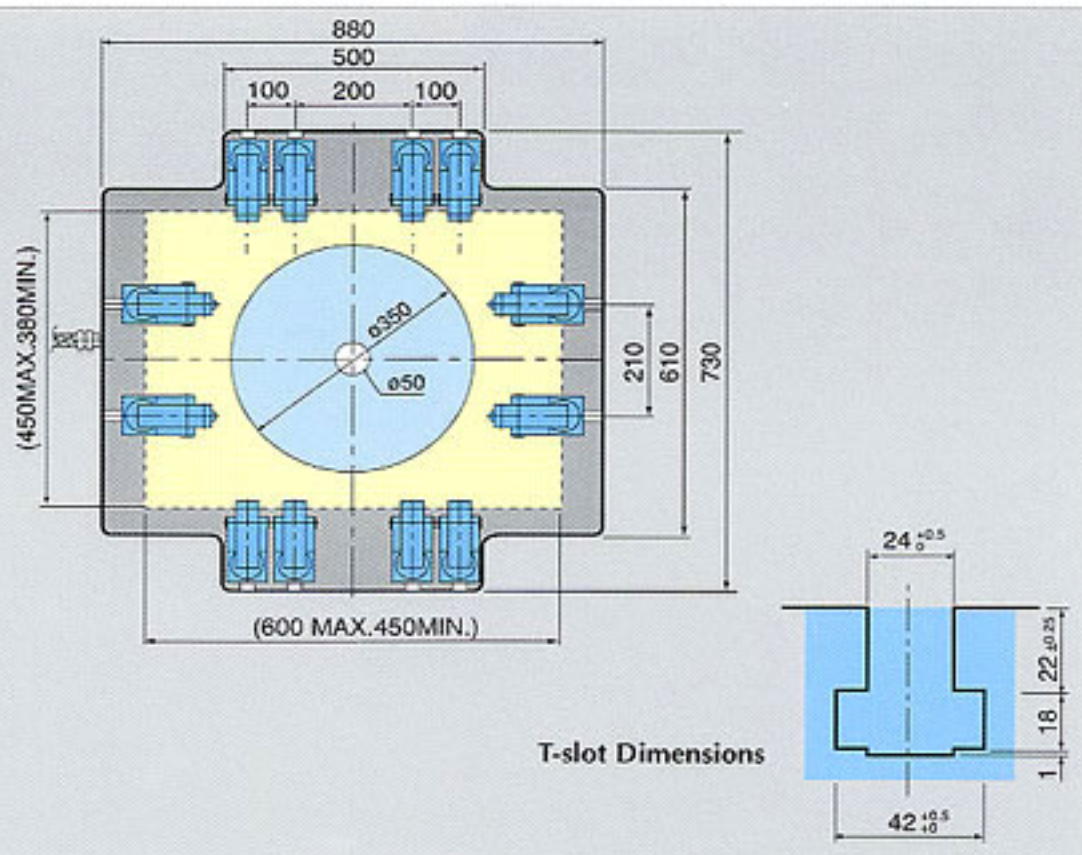

MODEL FP7L & SPECIFICATIONS

Model	FP7L SERIES
Stripping Capacity 脫料能力	Adjustable 63.0 tf Max.
Hold-down Capacity 壓板能力	Adjustable 36.0 tf Max.
Stripping Pad Stroke 打板行程	5mm
Press Tonnage 適用沖床	150-200 tf.
FP Plate Thickness 脫料台盤厚度	148mm
FP Plate Weight 脫料台盤重量	800kg
Upper Die Clamp 上模夾模器	TY- 6 / 12 PCS
Lower Die Clamp 下模夾模器	TY- 10 / 2 PCS
FORWELL die clamping system is provided as a standard accessory.	

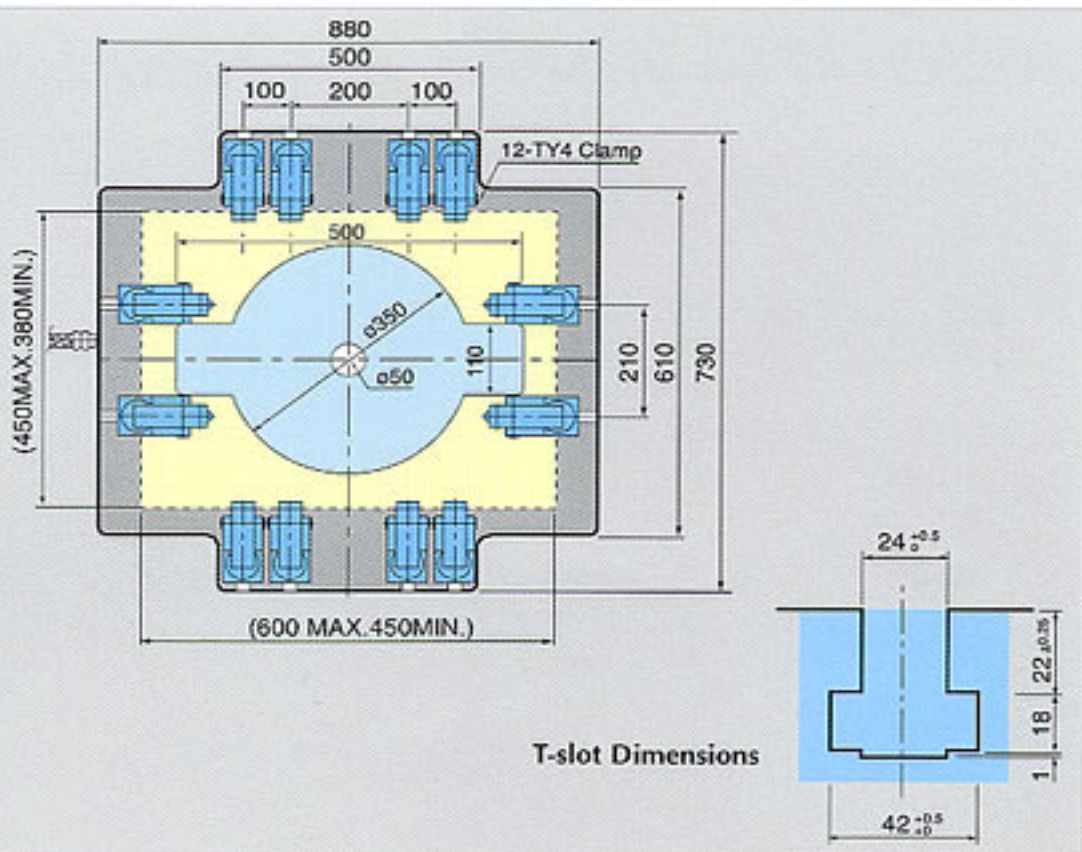

沖孔油壓脫料之特性 / FP PLATE SPECIFICATIONS

MODEL FP8 & SPECIFICATIONS

Model	FP8 SERIES
Stripping Capacity 脫料能力	Adjustable 100.0 tf Max.
Hold-down Capacity 壓板能力	Adjustable 50.0 tf Max.
Stripping Pad Stroke 打板行程	5mm
Press Tonnage 適用沖床	200-350 tf.
FP Plate Thickness 脫料台盤厚度	160mm
FP Plate Weight 脫料台盤重量	950kg
Upper Die Clamp 上模夾模器	TY- 6 / 16 PCS
Lower Die Clamp 下模夾模器	TY- 10 / 2 PCS
FORWELL die clamping system is provided as a standard accessory.	

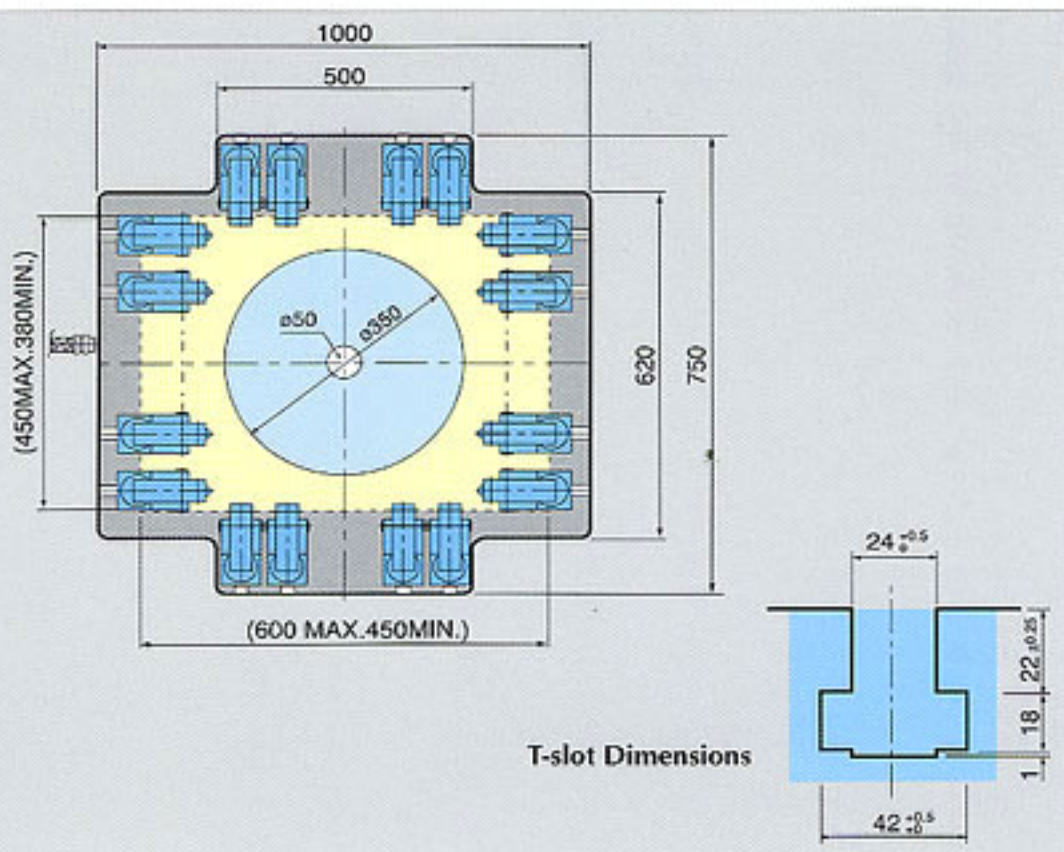

MODEL FP8L & SPECIFICATIONS

Model	FP8L SERIES
Stripping Capacity 脫料能力	Adjustable 100.0 tf Max.
Hold-down Capacity 壓板能力	Adjustable 50.0 tf Max.
Stripping Pad Stroke 打板行程	5mm
Press Tonnage 適用沖床	200-350 tf.
FP Plate Thickness 脫料台盤厚度	160mm
FP Plate Weight 脫料台盤重量	950kg
Upper Die Clamp 上模夾模器	TY- 6 / 12 PCS
Lower Die Clamp 下模夾模器	TY- 10 / 2 PCS
FORWELL die clamping system is provided as a standard accessory.	

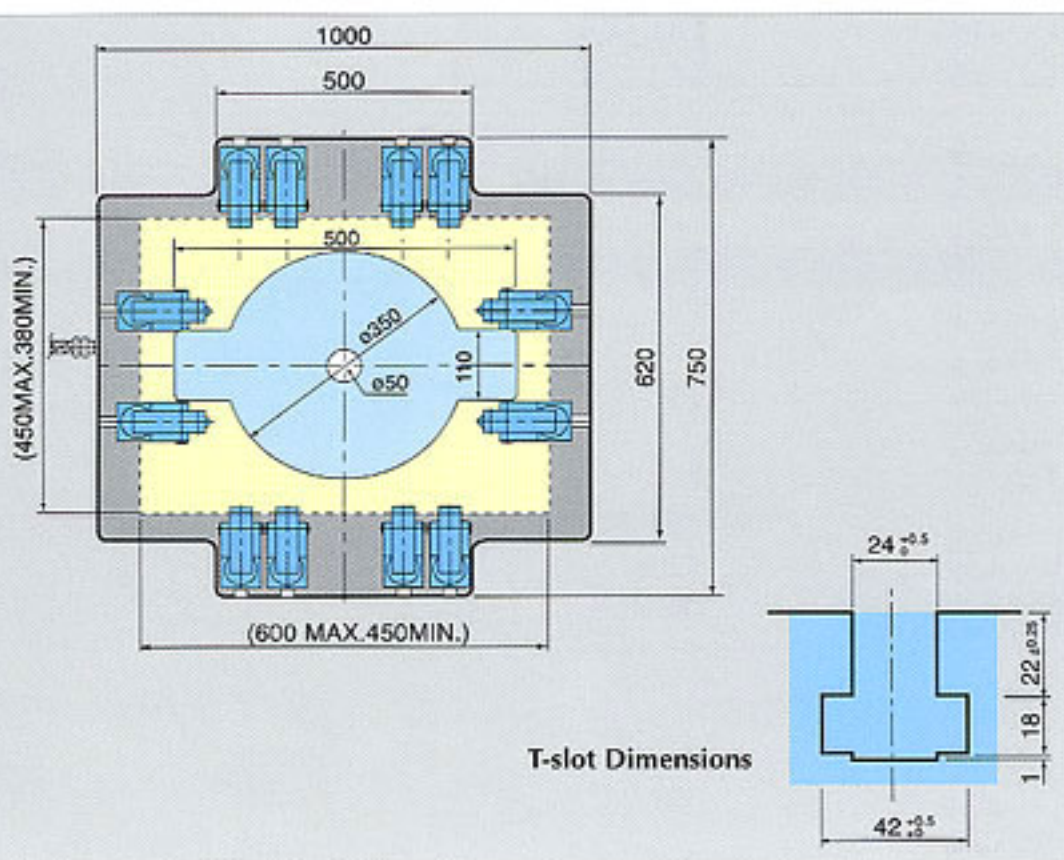

*註：品質不斷改良，尺寸變更不另行通知。
Due to the continuing innovations, product dimensions subject to change without further notice.

訂購資料表 / DATA FOR PLACING ORDER

如須訂購請詳細填寫下列之規格表，以方便作業 / PLEASE SPECIFY THE FOLLOWING

沖床規格 SPECIFICATIONS OF PRESS

1	New or Existing 新機或舊機	<input type="checkbox"/> New <input type="checkbox"/> Existing
2	Maker & Model 廠牌型式	
3	Capacity 沖壓能力	tf
4	Stroke 行程	mm
5	Die Height 最大模高	mm
6	Slide Adjustment 滑塊調整	mm
7	Press Slide 沖床上滑塊尺寸	AA BB
8	FP Plate Mounting Bolt Hole Pitch 固定孔中心尺寸	CC DD
9	FP Plate Bolt Hole Diameter 螺絲孔尺寸	mm \varnothing
10	Frame Gap 骨架間距	C mm
11	Balance Capacity 平衡氣缸能力	kg
12	Die Length a.MAX MIN. 模具長度	a.MAX MIN. mm
13	Die Width b.MAX MIN. 模具寬度	b.MAX MIN. mm
14	Die Thickness 模具厚度	h ₁ k ₁ h ₂ k ₂
15	Die Maximum Weight 模具最大重量	kg

外型尺寸 PHYSICAL DIMENSIONS

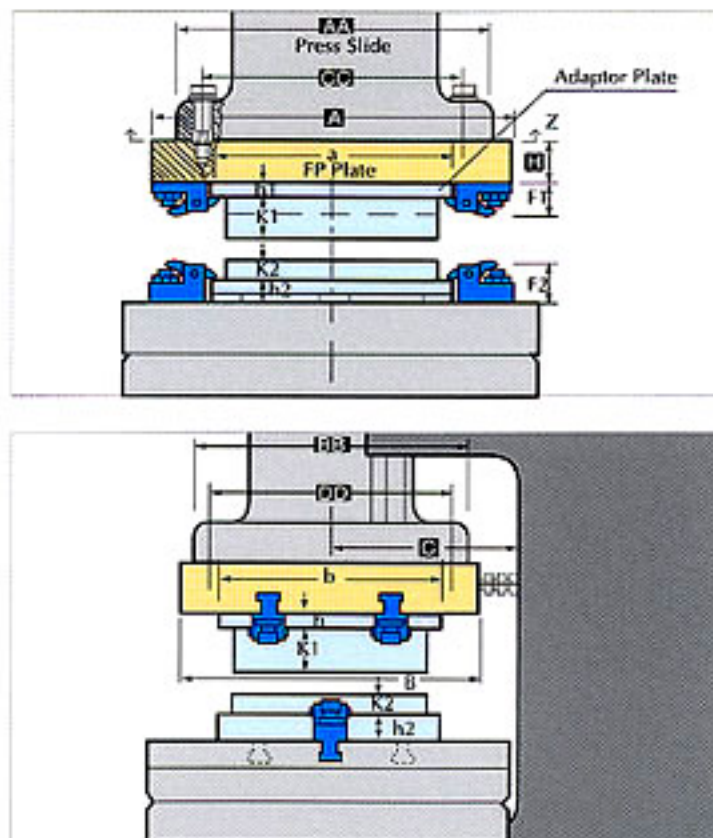

T槽尺寸 T-SLOT DIMENSIONS

	A	B	C	D
Slide 滑塊板	mm	mm	mm	mm
Bolster 平板	mm	mm	mm	mm

FROM P1

公司名稱 / COMPANY: _____ 聯絡人 / ATTN: _____

地址 / ADD: _____

電話 / TEL: _____ 傳真 / FAX: _____

訂購資料表 / QUOTATION INFORMATION FORM

(如果您訂購二台以上沖床換模系統，請明列每台沖床資料) (請COPY使用)

(If you require quotation for more than one press, please copy this form for each machine)

A PART ABOUT PRESS 沖床部份	A1	New or Existing 新購或舊有	<input type="checkbox"/> New 新購	<input type="checkbox"/> Existing 舊有		
	A2	Manufacturer and model 製造商及型號	Manufacturer 製造商	<input type="text"/>	Model 型號	<input type="text"/>
	A3	Type of press 沖床型式	<input type="checkbox"/> C Frame	<input type="checkbox"/> Straight Side 直柱型		
			<input type="checkbox"/> Transfer	<input type="checkbox"/> Other Specify (其它 <input type="text"/>)		
	A4	Tonnage 沖壓能力	<input type="checkbox"/> tf	<input type="checkbox"/> US 美制	<input type="checkbox"/> Metric 公制	
	A5	Slide dimensions 滑塊尺寸	(L-R) <input type="text"/>	X (F-B) <input type="text"/>	mm (inch)	
	A6	Bolster dimensions 台盤尺寸	(L-R) <input type="text"/>	X (F-B) <input type="text"/>	mm (inch)	
A7	T-slot T槽 (詳細測量)	<input type="checkbox"/> Yes 有	<input type="checkbox"/> No 沒有	Dimension 尺寸	A: <input type="text"/> C: <input type="text"/> B: <input type="text"/> D: <input type="text"/>	

B PART ABOUT DIES 模具部份	B1	Max. weight 最大重量	<input type="text"/>	kg (lbs)		
	B2	Max. dimensions 最大尺寸	(W) <input type="text"/>	x(L) <input type="text"/>	x(H) <input type="text"/>	mm (inch)
	B3	U-cut for bolting 螺栓用“U”槽	<input type="checkbox"/> Yes 有	<input type="checkbox"/> No 沒有		
	B4	Die shoe thickness 模具邊緣厚度	<input type="text"/>	mm (inch)		
	B5	Bottom 模具底部	<input type="checkbox"/> Plain 平面	<input type="checkbox"/> Lattice 格子狀		
	B6	Special requirements 特殊需求	<input type="text"/>			

C PART ABOUT DIES CHANGE SYSTEM 換模組件部份	C1	Required components 所需組件	Clamp 夾模器	Model 型式	<input type="text"/>	X	<input type="text"/>	PCS 個
		Lifting Roller 舉模器	Model 型式	<input type="text"/>	X	<input type="text"/>	PCS 個	
		Bolster Extension 移模臂	Model 型式	<input type="text"/>	X	<input type="text"/>	PCS 個	
		Power Unit 氣動泵組合	Model 型式	<input type="text"/>	X	<input type="text"/>	PCS 個	
	C2	Valve Operation 閥門操作	<input type="checkbox"/> Manual 手動式	<input type="checkbox"/> Automatic 電氣操作式				
	Power Supply 電力規格	<input type="checkbox"/> AC	<input type="checkbox"/> DC	<input type="checkbox"/> Volt	<input type="checkbox"/> Hz			

FROM P2

公司名稱 / COMPANY :

連絡人 / ATTN :

FORWELL™

品質、服務、創新

富偉精機股份有限公司
FORWELL PRECISION MACHINERY CO., LTD.

彰化縣埔心鄉經口村明聖路二段399號
NO.399, SEC. 2, MINGSHENG RD.,
PUSIN TOWNSHIP, CHANGHUA COUNTY
513, TAIWAN
TEL : 886-4-8345196
FAX : 886-4-8345197
<http://www.forwell.com>
E-mail : forwell@forwell.com

中國寧波廠：
浙江省寧波市鎮海經濟開發區金誠路8號 郵編：315200
TEL : 0574-86599196
FAX : 0574-86599197

深圳辦事處：
深圳市寶安區沙井街道沙三上下圍第三工業區創業工業區4棟3樓C3 郵編：518104
TEL : 0755-27513796
FAX : 0755-27513797

富偉公司最新國際行銷組員一覽表 International Marketing Staff of FORWELL

