



我就是鐵牛 I am OX.

CNC立橫銑床

VERTICAL/ HORIZONTAL CNC MILLING MACHINE

適合夾治具、模具、開發件、少量多樣型加工，追加分度盤可做多面體之加工。  
Suitable for machining jigs, fixtures, molds and under-development pieces on a small-volume but variety basis and installing rotary table processing on polyhedral work-pieces



千誠機械股份有限公司  
CHIEN CHENS MACHINERY CO., LTD.



台灣桃園市中壢區福星六街60之2號  
No. 60-2, Fu Hsing 6th St., Chung Li Dist.,  
Tao Yuan City, Taiwan  
Tel: 886-3-462-6421 Fax: 886-3-462-7645  
E-mail: chienchens@hotmail.com.tw  
http://www.oxmachine.com

台中廠地址：  
台中市石岡區豐勢路山下巷28-1號  
No.28-1, Shanxia Ln., Fengshi Rd.,  
Shigang Dist., Taichung City, Taiwan



千誠機械股份有限公司  
CHIEN CHENS MACHINERY CO., LTD.

[www.oxmachine.com](http://www.oxmachine.com)

# NT50#(BT) — 齒輪頭傳動結構

Gear Head Transmission Structure



Z 軸滾珠導桿傳動(無手動把手)  
Z-axis Ball Screw Transmission  
(without manual handle)

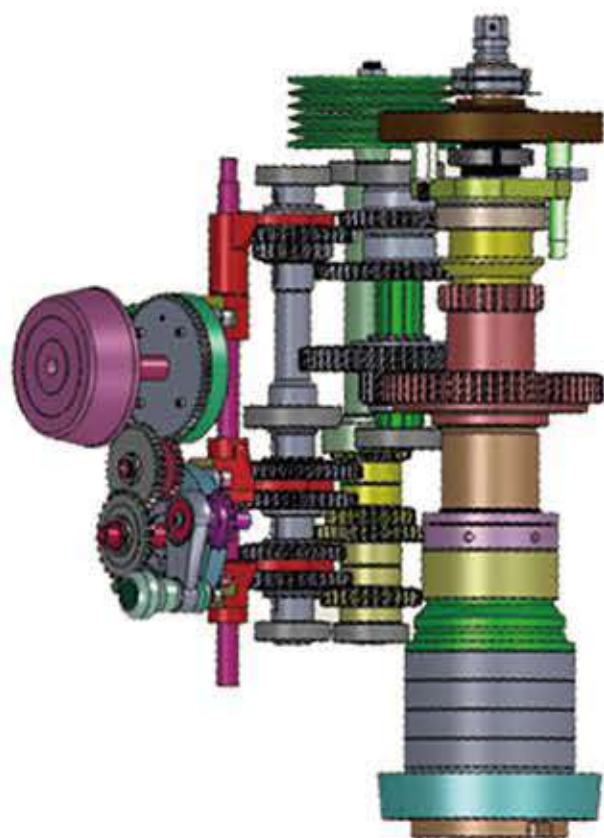

## 兩軌/四軌底座

Dual / Four-guideway Base

### 兩軌底座

Dual-guideway Base



X行程1300mm用  
for X travel 1300mm



X行程1500mm用  
for X travel 1500mm

### 四軌底座

Four-guideways Base



X行程2400mm用  
for X travel 2400mm

# 老師傅的最愛-教導功能

Instruction-typed Function

## CNC+教導功能+傳統=3用

CNC + Instruction + Tradition = Tri - Use

### 四軸CNC控制

Four-axis CNC Control

#### 功能：

- 一般G/M碼操作
- 背景編輯
- 巨集程式功能
- 程式傳輸加工功能
- 多國語言
- 圖形模擬顯示
- 硬體自我診斷顯示
- MPG執行加工程式

#### Function:

- General G/M Code Operation
- Background Editing
- Program Function
- Program Transmission Function
- Multi-national Languages
- Pattern Simulated Display
- Hardware Self-diagnosis Display
- MPG Execute Program



### 教導功能 Instruction

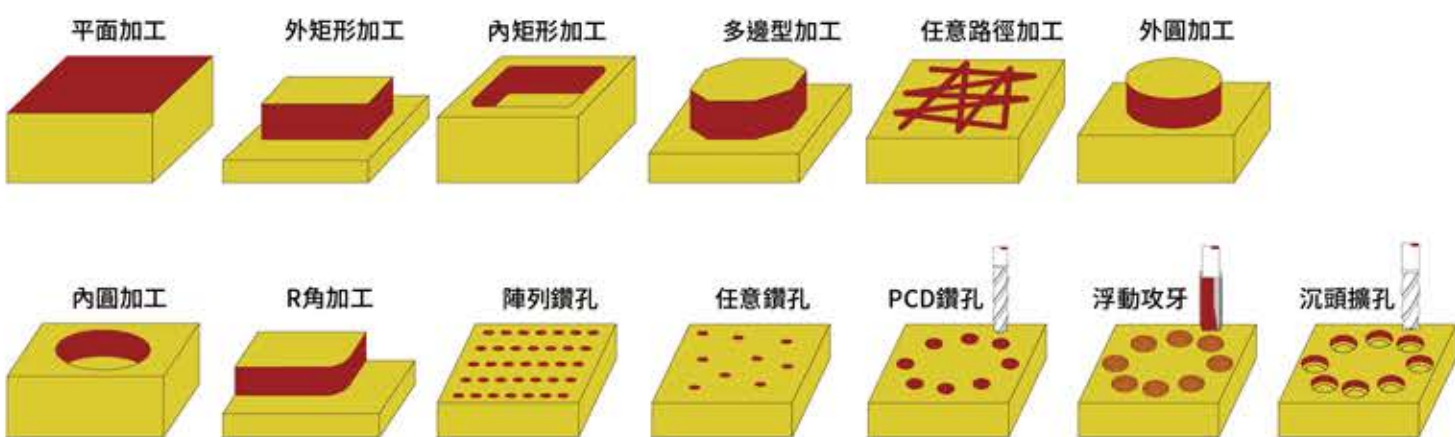

# 臥式切削機構

Horizontal Type Machining Structure

## H臥式齒輪頭切削機構(選配)

H Horizontal Type Machining Structure (Optional Equipment)

臥式主軸規格NT/BT#40(#50) Horizontal type milling head specifications NT/BT#40(#50)
主馬達NT#40 5HP/4P, NT#50 7.5HP/4P Spindle motor NT#40 5HP/4P, NT#50 7.5HP/4P
上下行程NT#40:370(選配:500)mm, NT#50:570mm Vertical travel NT#40:370(op:500)mm, NT#50:570mm
NT#40方牙桿 或 滾珠螺桿, NT#50滾珠螺桿 NT#40 acme screw or ballscrews, NT#50 ballscrews
減速機無段伺服傳動移動速率 10~1200mm/min Reducer non-step servo transmission moving speed 10~1200mm/min
主軸轉速: NT#40:57~1227rpm, NT#50:62~1100rpm(6段轉速) Spindle speed: NT#40:57~1227rpm, NT#50:62~1100rpm (6-step speed)

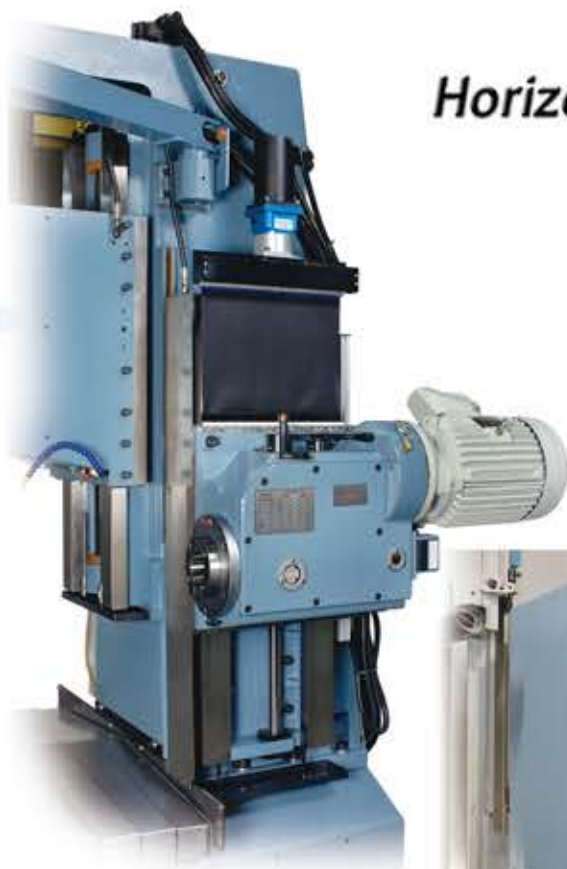

NT#50



NT#40

## HK臥式砲塔型切削機構(選配), 含攻、鑽、搪、銑等功能

HK Horizontal Turret Type Machining Structure (Optional) tapping, drilling, boring, and milling are available.



臥式主軸規格: NT/BT#40(#50) Horizontal type milling head specifications NT/BT#40(#50)
主馬達5HP/4P(60HZ) Spindle motor 5HP/4P(60HZ)
主軸自動推送, 每轉一圈0.035/0.07/0.14mm。 Automatic spindle feeding feature, with each round standing at 0.035/0.07/0.14mm.
上下行程NT#40:370(選配:500)mm, NT#50:570mm Vertical travel NT#40:370(op:500)mm, NT#50:570mm
方牙桿 或 滾珠螺桿, (Φ32mm P=8mm) Acme screw or ballscrews, (Φ32mm p=8mm)
減速機無段伺服傳動移動速率10-1200 mm/min Reducer non-step servo transmission moving speed 10-1200 mm/min
主軸轉速: 低速57~432rpm, 高速424~3600rpm, 變頻無段。 Spindle Speed: Low speed: 57~432rpm high speed: 424~3600rpm. Frequency conversion and step-less.
砲管伸縮行程140mm Turret travel 140mm

## 四軸CNC控制

Four-axis CNC Control

老師傅的最愛-教導功能

Instruction-typed Function

CNC+教導功能+傳統=3用

CNC + Instruction + Tradition = Tri - Use

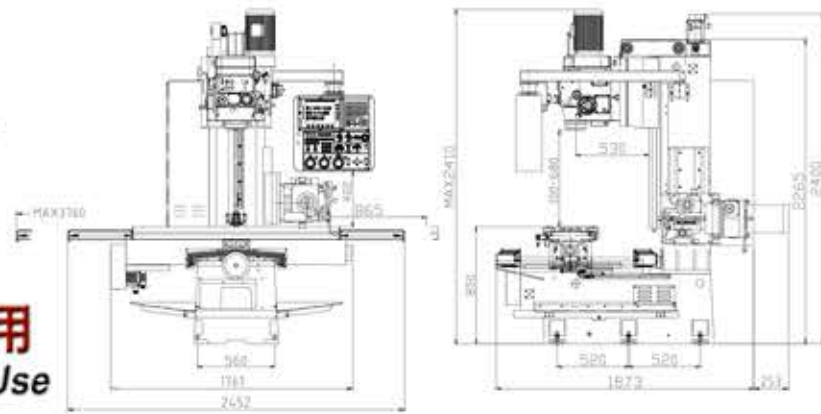

**OX-2BHK**

### 規格 Specification

工作台尺寸 Table size: 1500 x 400 mm  
 X 軸行程 X axis travel: 1300 mm  
 Y 軸行程 Y axis travel: 500 mm  
 Z 軸行程 Z axis travel: 580 mm  
 A 軸行程 A axis travel: 370 mm  
 Y 軸軌道寬 Y slide way width: 620 mm  
 Z 軸軌道寬 Z slide way width: 420 mm

主軸斜度 Spindle taper: NT#40(BT)  
 主軸馬達 Spindle motor: 5HP / 4P  
 主軸轉速 Spindle speed: 70~3540 RPM  
 快速進給速率 Feeding speed: 10~6000 mm/min  
 橫主軸5HP變頻無段: Hori. Spindle: 57~3600 RPM  
 (A軸梯形牙 A axis acme screw)  
 滾珠螺桿 Ballscrew: Ø32 mm P=5 C3 級  
 淨重 Net weight: 3500 kgs

## Z 軸齒排傳動

Z-axis Gear Transmission

保留傳統操作功能-人性化、  
輕巧、靈活、精準、MPG手輪

Reserves traditional operation  
functions.

Easy, smart, and precision  
MPG hand wheel.

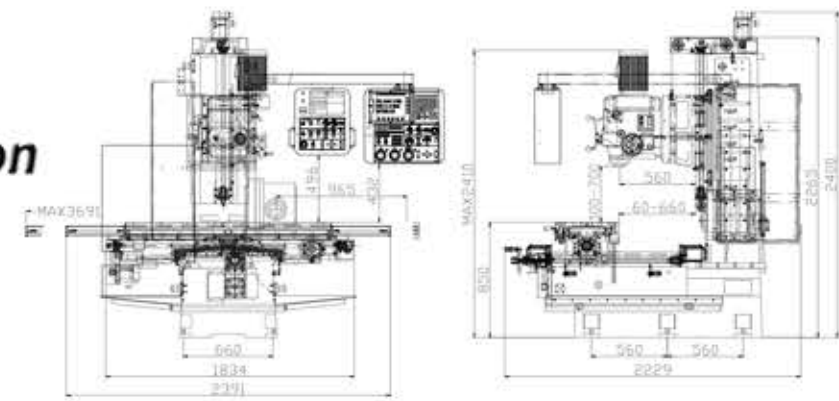

**OX-3**

### 規格 Specification

工作台尺寸 Table size: 1515 x 470 mm  
 X 軸行程 X axis travel: 1300 mm  
 Y 軸行程 Y axis travel: 600 mm  
 Z 軸行程 Z axis travel: 600 mm  
 Y 軸軌道寬 Y slide way width: 720 mm  
 Z 軸軌道寬 Z slide way width: 420 mm

主軸斜度 Spindle taper: NT#40(BT)  
 主軸馬達 Spindle motor: 5HP / 4P  
 主軸轉速 Spindle speed: 70~3600 RPM  
 快速進給速率 Feeding speed: 10~6000 mm/min  
 滾珠螺桿 Ballscrew: Ø32 mm C7 級  
 淨重 Net weight: 3200 kgs

# 四軸CNC控制 Four-axis CNC Control

老師傅的最愛-教導功能  
Instruction-typed Function

CNC+教導功能+傳統=3用  
CNC + Instruction + Tradition = Tri - Use

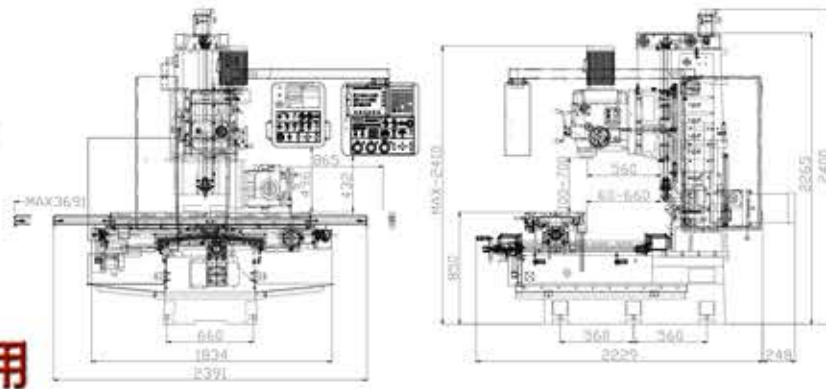

## 規格 Specification

工作台尺寸 Table size: 1515 x 470 mm  
X 軸行程 X axis travel: 1300 mm  
Y 軸行程 Y axis travel: 600 mm  
Z 軸行程 Z axis travel: 600 mm  
A 軸行程 A axis travel: 370 mm(OP: 500mm)  
Y 軸軌道寬 Y slide way width: 720 mm  
Z 軸軌道寬 Z slide way width: 420 mm

主軸斜度 Spindle taper: NT#40(BT)  
主軸馬達 Spindle motor: 5HP / 4P  
主軸轉速 Spindle speed: 70~3600 RPM  
快速進給速率 Feeding speed: 10~6000 mm/min  
橫主軸5HP變頻無段Hori. Spindle:75~3600 RPM  
(A軸梯形牙 A axis acme screw)  
滾珠螺桿 Ballscrew: Ø32 mm C3 級  
淨重 Net weight: 3500 kgs

**OX-3BHK**

# 四軸CNC控制 Four-axis CNC Control

老師傅的最愛-教導功能  
Instruction-typed Function

CNC+教導功能+傳統=3用  
CNC + Instruction + Tradition = Tri - Use

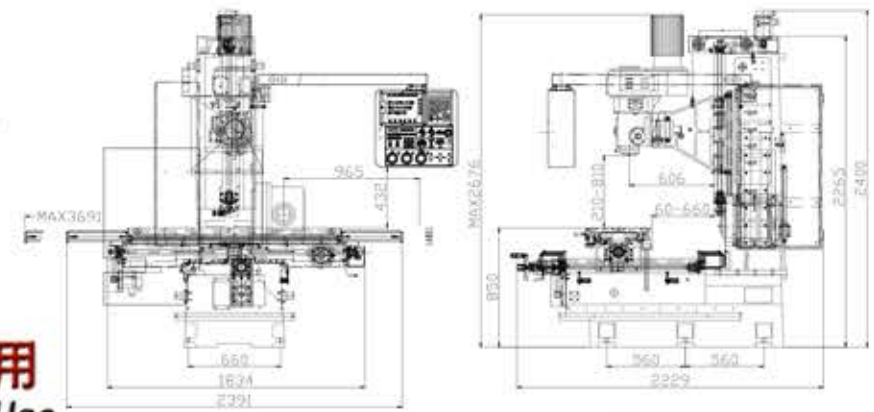

## 規格 Specification

工作台尺寸 Table size: 1515 x 470 mm  
X 軸行程 X axis travel: 1300 mm  
Y 軸行程 Y axis travel: 600 mm  
Z 軸行程 Z axis travel: 600 mm  
A 軸行程 A axis travel: 370 mm (op:500mm)  
Y 軸軌道寬 Y slide way width: 720 mm  
Z 軸軌道寬 Z slide way width: 420 mm  
滾珠螺桿 Ballscrew: Ø32 mm C3 級

主軸斜度 Spindle taper: NT#40(BT)  
主軸馬達 Spindle motor: 5HP / 4P  
主軸轉速 Spindle speed: 75~3600 RPM  
立主軸砲管伸縮行程 Spindle Barrel Telescopic Travel: 140 mm/min  
主軸簡易攻牙裝置 Spindle Simple Tapping Device  
橫主軸齒輪6速5HP變頻無段 Hori. Spindle 6 Gear: 57~1227 RPM  
(A軸梯形牙 A axis acme screw)  
淨重 Net weight: 3500 kgs

**OX-3BTH**

## 三軸CNC控制

Three-axis CNC Control

老師傅的最愛-教導功能

Instruction-typed Function

CNC+教導功能+傳統=3用

CNC + Instruction + Tradition = Tri - Use

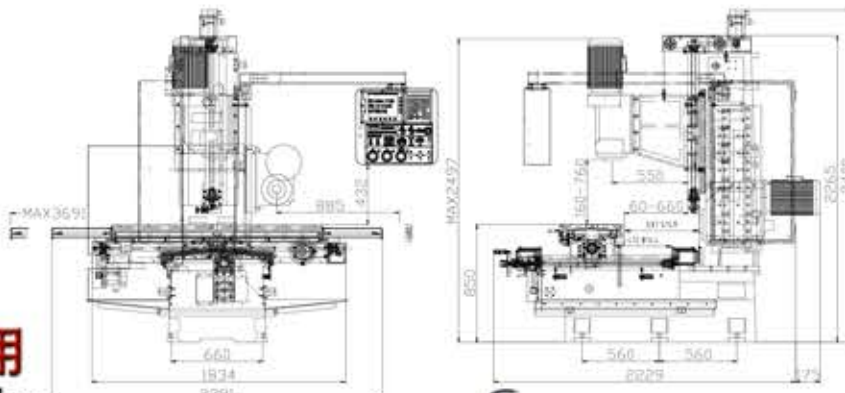

**OX-3BG-50**

### 規格 Specification

工作台尺寸 Table size: 1515 x 470 mm  
 X 軸行程 X axis travel: 1300 mm  
 Y 軸行程 Y axis travel: 600 mm  
 Z 軸行程 Z axis travel: 600 mm  
 Y 軸軌道寬 Y slide way width: 720 mm  
 Z 軸軌道寬 Z slide way width: 420 mm

主軸斜度 Spindle taper: NT#50(BT)  
 主軸馬達 Spindle motor: 7.5HP / 4P  
 主軸轉速 Spindle speed: 62~1100 RPM  
 快速進給速率 Feeding speed: 10~6000 mm/min  
 滾珠螺桿 Ballscrew: Ø32 mm C3 級  
 淨重 Net weight: 3200 kgs

## 三軸滾珠螺桿

Three-axis Ballscrew

保留傳統操作功能-人性化、  
輕巧、靈活、精準、MPG手輪

Reserves traditional operation  
functions.

Easy, smart, and precision  
MPG hand wheel.

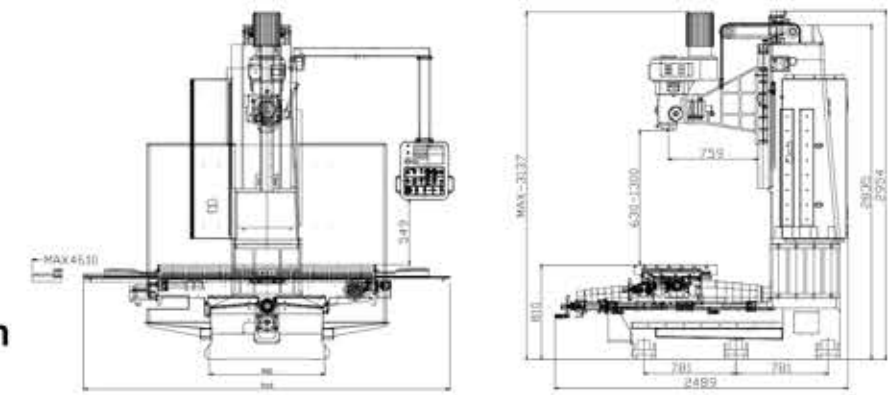

Z: 670mm  
 Y: 800mm  
 X: 1500mm



**OX-5BT(加高型)**

### 規格 Specification

工作台尺寸 Table size: 1850 x 650 mm  
 X 軸行程 X axis travel: 1500 mm  
 Y 軸行程 Y axis travel: 800 mm  
 Z 軸行程 Z axis travel: 670 mm  
 Y 軸軌道寬 Y slide way width: 1000 mm  
 Z 軸軌道寬 Z slide way width: 500 mm  
 滾珠螺桿 Ballscrew: Ø40 mm P=8 C5 級

主軸斜度 Spindle taper: NT#40(BT)  
 主軸馬達 Spindle motor: 5HP / 4P  
 主軸轉速 Spindle speed: 75~3600 RPM  
 立主軸砲管伸縮行程 Spindle Barrel Telescopic Travel: 140 mm/min  
 主軸簡易攻牙裝置 Spindle Simple Tapping Device  
 快速進給速率 Feeding speed: 10~6000 mm/min  
 淨重 Net weight: 5200 kgs

## Z 軸齒排傳動

### Z-axis Gear Transmission

保留傳統操作功能-人性化、  
輕巧、靈活、精準、MPG手輪

Reserves traditional operation  
functions.

Easy, smart, and precision  
MPG hand wheel.

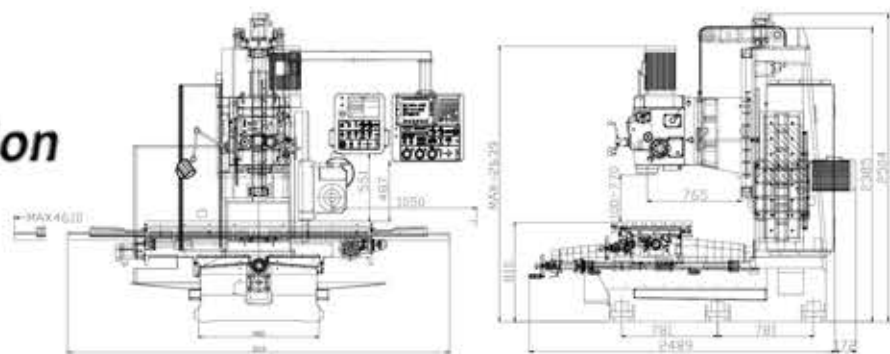

**OX-5-50H**

### 規格 Specification

工作台尺寸 Table size: 1850 x 650 mm

X 軸行程 X axis travel: 1500 mm

Y 軸行程 Y axis travel: 800 mm

Z 軸行程 Z axis travel: 670 mm

A 軸行程 A axis travel: 570 mm

Y 軸軌道寬 Y slide way width: 1000 mm

Z 軸軌道寬 Z slide way width: 500 mm

滾珠螺桿 Ballscrew: Ø40 mm P=8 C5 級

主軸斜度 Spindle taper: NT#50(BT)

主軸馬達 Spindle motor: 7.5HP / 4P

主軸轉速 Spindle speed: 40~3000 RPM

快速進給速率 Feeding speed: 10~6000 mm/min

橫主軸齒輪6速7.5HP變頻無段

Hori. Spindle 6 Gear 7.5HP :62~1100 RPM

淨重 Net weight: 5500 kgs

## 四軸CNC控制

### Four-axis CNC Control

老師傅的最愛-教導功能

Instruction-typed Function

CNC+教導功能+傳統=3用

CNC + Instruction + Tradition = Tri - Use

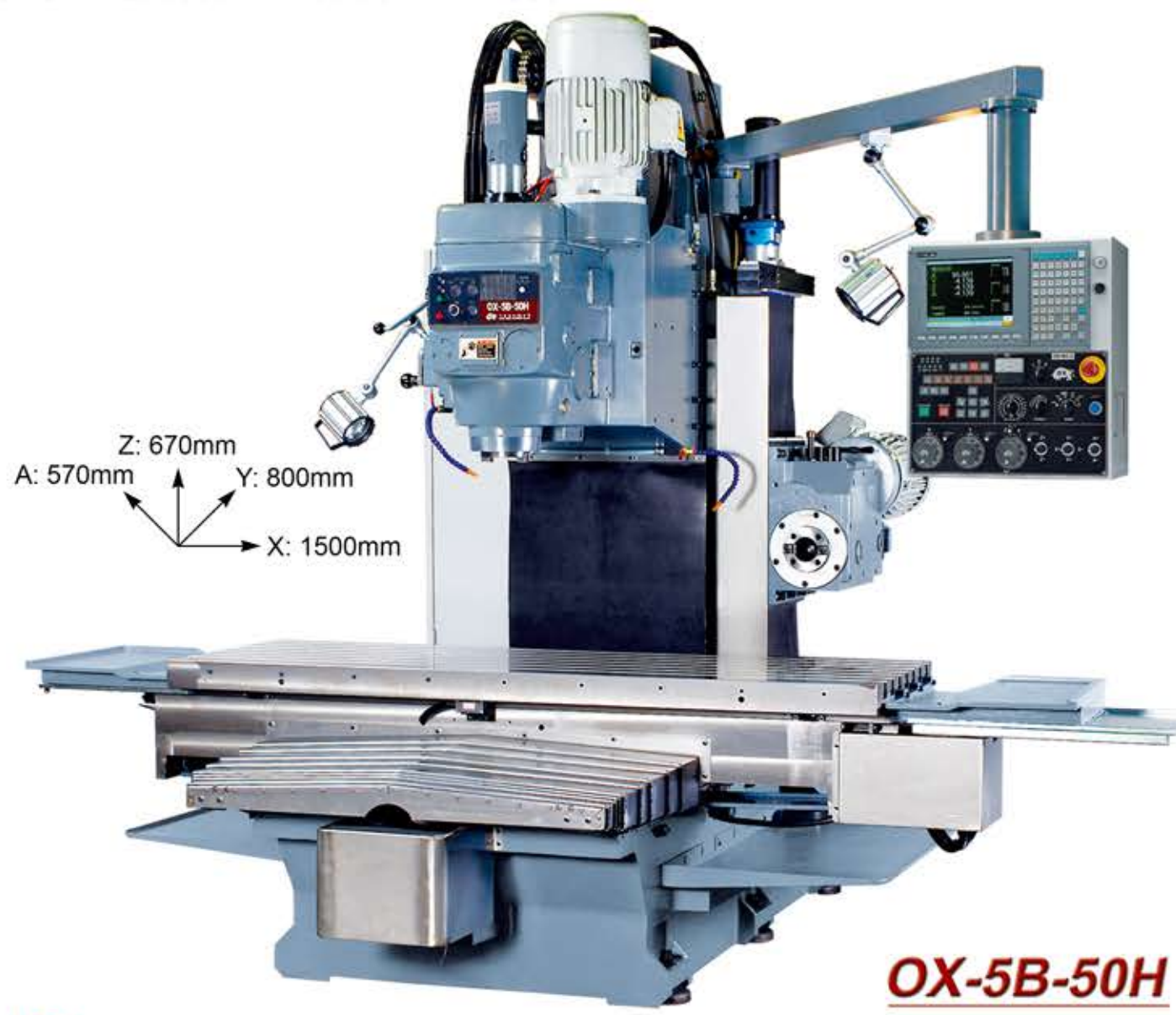
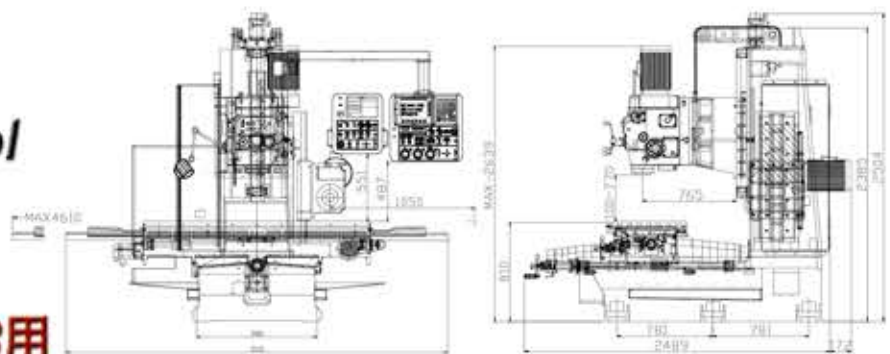

**OX-5B-50H**

### 規格 Specification

工作台尺寸 Table size: 1850 x 650 mm

X 軸行程 X axis travel: 1500 mm

Y 軸行程 Y axis travel: 800 mm

Z 軸行程 Z axis travel: 670 mm

A 軸行程 A axis travel: 570 mm

Y 軸軌道寬 Y slide way width: 1000 mm

Z 軸軌道寬 Z slide way width: 500 mm

滾珠螺桿 Ballscrew: Ø40 mm P=8 C5 級

主軸斜度 Spindle taper: NT#50(BT)

主軸馬達 Spindle motor: 7.5HP / 4P

主軸轉速 Spindle speed: 40~3000 RPM

快速進給速率 Feeding speed: 10~6000 mm/min

橫主軸齒輪6速7.5HP變頻無段

Hori. Spindle 6 Gear 7.5HP :62~1100 RPM

淨重 Net weight: 5500 kgs

## 四軸CNC控制 Four-axis CNC Control

老師傅的最愛-教導功能  
Instruction-typed Function

CNC+教導功能+傳統=3用  
CNC + Instruction + Tradition = Tri - Use

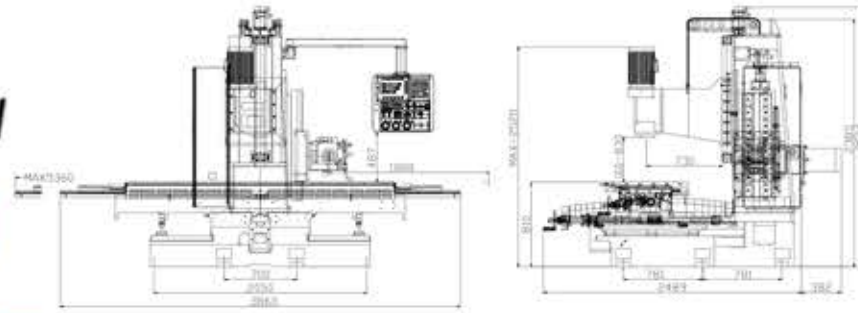

Z: 670mm  
A: 570mm  
Y: 800mm  
X: 2400mm



**OX-6BG-40HK**

### 規格 Specification

工作台尺寸 Table size: 2600 x 650(800) mm  
X 軸行程 X axis travel: 2400 mm  
Y 軸行程 Y axis travel: 800 mm  
Z 軸行程 Z axis travel: 670 mm  
A 軸行程 A axis travel: 570 mm  
Y 軸軌道寬 Y slide way width: 1000 mm  
Z 軸軌道寬 Z slide way width: 500 mm

主軸斜度 Spindle taper: NT#40(BT)  
主軸馬達 Spindle motor: 7.5HP / 4P  
主軸轉速 Spindle speed: 62~1100 RPM  
快速進給速率 Feeding speed: 10~6000 mm/min  
橫主軸5HP變頻無段Hori.Spindle:75~3600 RPM  
滾珠螺桿 Ballscrew: Ø40 mm P=8 C5 級  
淨重 Net weight: 6800 kgs

## 四軸CNC控制 Four-axis CNC Control

老師傅的最愛-教導功能  
Instruction-typed Function

CNC+教導功能+傳統=3用  
CNC + Instruction + Tradition = Tri - Use

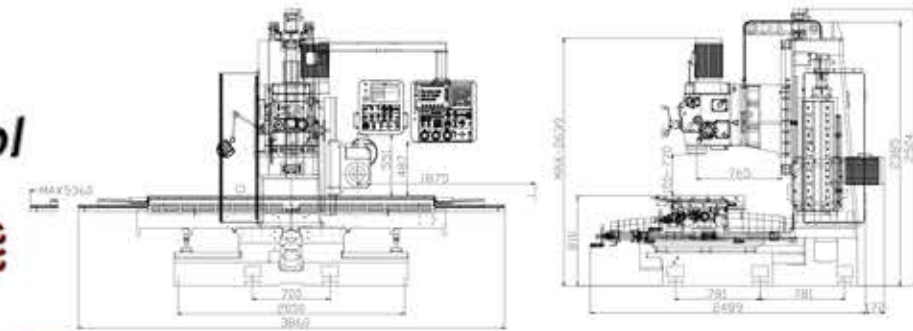

Z: 670mm  
A: 570mm  
Y: 800mm  
X: 2400mm



**OX-6B-50H**

### 規格 Specification

工作台尺寸 Table size: 2600 x 650(800) mm  
X 軸行程 X axis travel: 2400 mm  
Y 軸行程 Y axis travel: 800 mm  
Z 軸行程 Z axis travel: 670 mm  
A 軸行程 A axis travel: 570 mm  
Y 軸軌道寬 Y slide way width: 1000 mm  
Z 軸軌道寬 Z slide way width: 500 mm

主軸斜度 Spindle taper: NT#50(BT)  
主軸馬達 Spindle motor: 7.5HP / 4P  
主軸轉速 Spindle speed: 40~3000 RPM  
快速進給速率 Feeding speed: 10~6000 mm/min  
滾珠螺桿 Ballscrew: Ø40 mm P=8 C5 級  
淨重 Net weight: 6800 kgs