



變壓器 · 熔接機

Transformers & Welding Machine



裕新電機廠有限公司
YUH SHIN ELECTRIC CO., LTD.

台灣台中市40768西屯區工業42路22號
No.22, Gongyequ 42nd Rd., Xitun Dist.,
Taichung City 407, Taiwan
TEL:+886-4-23595358 . 23595359
FAX:+886-4-23597368
E-mail:yuhshin.tr@gmail.com
<http://www.yuhshin.com>



裕新電機廠有限公司
YUH SHIN ELECTRIC CO., LTD.

公司沿革

company history



EL/2006/5011C

1982年創立

設廠於台中縣沙鹿鎮中樓路，廠房面積二百平方公尺。主要生產配電用、動力用油浸式變壓器；銷售通路水電工程、工廠、公共工程。

YUH SHIN was founded in 1982 with a 200 sq.m. factory on Chung-lou Road in Shalu Township, Taichung County in Taiwan. The product line included oil-cooled transformers for electrical and mechanical systems, with sales to plumbing and electrical contractors, factories and public construction contractors.

1985至1990年

開發空壓型熔接點焊機、輪焊機、碰焊機用變壓器及多用途、移動式、電容式熔接用變壓器；銷售對象包括機電專業製造廠、產品使用於汽機車整車組立廠、零件廠、OA辦公家具廠、展示架製造廠等。

The company later developed transformers for pneumatic spot welders, seam and butt welders as well as versatile, highly portable transformers for capacitor-type welders. These were marketed to machinery manufacturers and widely used in automobile and motorbike assembly, parts production, OA equipment manufacturing and the production of display cases.

1991至1993年

開發高週波加熱機、高週波熔解爐專用變壓器、銷售於機電專業製造廠。

Transformers for use in high frequency induction melting furnace, with sales to electrical appliance manufacturers.

1993年

遷廠至台中工業區現在地址，廠房面積三千平方公尺；資本額：5000萬。

The company now boasts a 3000 sq.m. in the Taichung Industrial District and is backed by capitalization of NT\$50 million.

1994至1996年

開發H級、F級、H級填充型、B級模注型、配電用乾式變壓器、銷售對象CNC工作母機廠、水電工程、公共工程。Later developments included H-class, F-class, H-class filed-type, B-class injection molded-type and dry transformers for circuits, with sales to makers of CNC machine tools, electrical and plumbing contractors and public construction contractors.

1996至1997年

開發變頻器用電抗器、馬達起動用電抗器、電容器用電抗器等。

Resistors for inverters, start-up resistors for motors and resistors for capacitors.

1998年

成功研發高科技產品有各式入力單相、三相，出力精密全波整流型抵抗熔接變壓器，適合安裝於空壓式點焊機、碰焊機、輪焊機、各種抵抗熔接專用機及真空電鍍機。

1999年提出申請專利、2001年正式取得中華民國及大陸專利權、並正式量產；銷售對象包括機電專業製造廠、產品使用於國軍兵工廠、IC晶體封裝廠、汽機車整車組立廠及零件廠等。

High-tech products are also available such as single and three-phase Inverter DC type welding transformer that are suited resistance spot welder, Butt, seam various resistance type welding machine and Vacuum metallizing machine. Patents for these products were applied for in 1999 and obtained for Taiwan and China in 2001. Volume production then began, with sales to electrical machinery producers, defense department manufactures, IC component assemblers, automobile and motorcycle plants and other parts manufacturers.

2001年

新研發6KVA空壓型手提式點焊機，電流調整、通電時間、採用新研發高科技微電腦PC控制板，產品使用於機械板金、汽車板金、OA辦公室傢具廠等。

A new 6KVA portable spot welder was introduced featuring adjustable current and welding time and a newly-developed high-tech PC control panel. This machine is designed for use with machine bodies, automobile bodies and in office furniture factories.

2001年

開發晶圓廠污水處理用、積體電路板鍍銅用、國防戰鬥機及直升機起動用、高科技精密直流電源機。

Develop products include high-tech precision DC power supply for wastewater treatment in wafer fabs and in compound circuit board electroplating operations.

2005年

新研發50-150KVA變頻式熔接變壓器，安裝於變頻式點焊、閃焊、輪焊之熔接機，適用於鋁、青銅、不鏽鋼、鐵板等材料焊接。

Research and develop 50-200KVA inverter welding transformers for use in inverter type spot, flash and application covers a variety of materials, such as aluminium, bronze, stainless steel, iron plate, etc.

2006年

開發時序控制變頻式(INVERTOR)抵抗熔接機

Also develop time-controlled inverter-type resistance welder.

通過EN61558-1:1988, EN61558-2-4:1988之CE認證，證書編號：EN/2006/5011C

Pass CE authentication of EN61558-1:1988, EN61558-2-4:1988, The certificate serial number: EN/2006/5011C

2007年

開發變頻式(INVERTOR)直流電焊機，進駐彰化師大育成中心合作開發案。Also develop a inverter-type DC ARC Welders, and develop with incubation centre of national changhua university of education.

2008年

成功開發世界第一台最輕巧變頻式環保電焊機，節省電力達50%以上。

We successfully develop the first lightest and environment-friendly frequency converting electric welding machine that can save the electricity for more than 50%.

2011年

取得日本テトラック株式会社抵抗熔接設備台灣總代理權。

2011 gain Japan TETRA-K Electronic resistance welding equipment, Taiwan General Agent Right.

2012年

取得THM株式会社精密熔接設備台灣總代理權。

2011 gain Japan, THM Co., Ltd. precision welding equipment, Taiwan General Agent Right.

經營理念

Our Business Philosophy

(1) 品牌經營、技術領先、盡善盡美、顧客為尊

(2) 不斷積極研發，朝高科技產品邁進

- Brand Management
- Leading Technology
- Pursuit of Perfection
- Customer Orientation
- Constant Research & Development
- Towards High-Tech Product Supply



創新、研發、卓越品質獎

未來展望

Look into the FUTURE

秉持著信譽、創新、進步、環保的企業精神及理念，力求完美的品質政策，期許創造及研發出更優質的產品，提供客戶更高效率的生產品質，是我們的目標。

In the future, we will continue to insist on

Reputation
Innovation
Progression
Environment-Friendly

as our enterprise spirit and philosophy that strives to perfection by increasing production efficiency and product quality for clients.



產品索引

INDEX

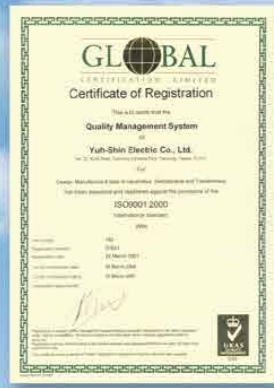

ISO 9001品質認證



CE 認證



中華民國專利
新型第198060號



中華民國專利
新型第205195號



中華民國專利
新型第160031號



中華民國專利
新型第169287號



中華民國專利
新型第170425號



中華民國專利
新型第178549號



中國大陸專利
證第號第340742號



中國大陸專利
證第號第397796號



中國大陸專利
證第號第341544號



中國大陸專利
證第號第489569號



中國大陸專利
證第號第515842號



中國大陸專利
證第號第393598號

	Page
無氧銅管燒焊機 Oxygen-free Copper Welder	5
變頻式電焊機 Inverter Arc Stick Welder	6
電容式植釘機 CD Stud Welding Machine	7
汽車修配廠鍍金拉平焊接機 AC Type Stud Welder Dent Pulling System (For car body dent removal)	8
白鐵焊道處理機 Weld Processor	9
電池壽命檢測器 Car Battery Tester	9
產業用乾式變壓器 Industrial Dry Transformers	10-15
油浸式變壓器 Oil-immersed Transformers	16-17
各式交流熔接變壓器 Resistance AC Welding Transformer	18-19
產業抵抗熔接機械專用變壓器 Resistance Welding Transformers for Manufacturing	20
各式單相入力.二次出力全波整流熔接變壓器 Single phase DC Welding Transformer	21
各式三相入力.二次出力全波整流熔接變壓器 Single, Three-phase DC Welding Transformer	22
變頻式二次出力全波整流熔接變壓器 Inverter Welding Transformers	23-24
直流電源機 DC Power Supply	25-27
交流電源機 AC Power Supply	28
全自動交流穩壓器 Fully-Automatic AC Voltage Regulator	29-30
電容式熔接用變壓器 Capacitor Discharge Welding Transformer	31
產業熔接機械專用變壓器 Welding Transformers for Manufacturing	32-34
二次電纜 Secondary Cable	35-36
懸吊式點焊機/焊臂 Portable Spot Welding Gun / Arms	37-38
電容型足踏、空壓式點焊熔接機 Desk Type Foot Pedal-Pneumatic Capacitor Discharge Spot Welding Machine	39-40
電容型空壓式點焊熔接機 Desk Type Pneumatic Capacitor Discharge Spot Welding Machine	41
交流型空壓式點焊熔接機 AC Type Pneumatic Spot Welding Machine	42
變頻型空壓式點焊熔接機 Pneumatic Inverter DC Spot Welding Machine	43
變頻型空壓式直流點焊熔接機 Pneumatic Inverter DC Spot Welding Machine	44
點焊熔接機 Spot Welding Machine	45-49
三相空壓式直流點焊熔接機/交流雙頭輪焊機 Three Phase Pneumatic Welding Machine / AC Twin-Head Welder	50
單相閃焊熔接機 Single Phase Flashing Welding Machine	51
碰焊熔接機 Butt Type Welding Machine	52-54

無氧銅管燒焊機

OXYGEN-FREE COPPER WELDER

產品特色 FEATURES

- 中溫焊接，無氧化物，銅管不會過熱變質。
- 焊接不易氧化日後不易發生焊接處氧化，造成漏冷媒阻塞。
- Medium temperature soldering copper tube produces no oxidized materials and degenerated.
- The welded joints will be not oxidized that leads to the refrigerant leakage and block the cooper tube



▶ 手提式
YSVRV20



▶ 手拉立式
YSVRV20U

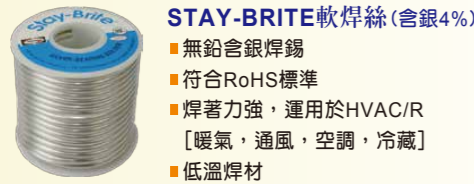

STAY-BRITE軟焊絲 (含銀4%)

- 無鉛含銀焊錫
- 符合RoHS標準
- 焊著力強，運用於HVAC/R [暖氣，通風，空調，冷藏]
- 低溫焊材



BRIDGIT軟焊絲 (含銀0%)

- 無鉛焊錫
- 符合RoHS標準
- 焊著力強，運用廣泛
- 低溫焊材



BRIDGIT FLUXES 焊膏

- 無鉛助焊劑，符合美國飲水安全法令
- 減少黑色碳化物之形成，避免裂縫之產生



規格 SPECIFICATIONS

型式	周圍溫度	定格入力電壓	輸入相數	頻率	輸出容量	出力電流調整範圍	出力時間調整範圍	冷卻方式	外觀尺寸 (寬x深x高)	重量
	°C	V	Ø	Hz	KVA	%	秒		mm	kg
YSVRV20	45°C以下	110(100)	1Ø	50/60	2	30~99	1~99	風扇冷卻	171x305x395	15
YSVRV20U	45°C以下	110(100)	1Ø	50/60	2	30~99	1~99	風扇冷卻	350x253x806	19.9

變頻式電焊機

INVERTER ARC STICK WELDER

環保電焊機 GREEN WELDERS



YSIW-200
變頻式電焊機
Inverter ARC Stick Welder
10KVA 160A



YSIW-400
變頻式電焊機
Inverter ARC Stick Welder
30KVA 400A



YSIW-600
變頻式電焊機
Inverter ARC Stick Welder
50KVA 600A

產品特色 Features

1. 節省電力50%以上、世界最輕巧、採用世界最尖端IGBT半導體、故障率比一般市面上使用Mosfet半導體變頻式電焊機降低15倍以上。
2. 變頻電焊機之電源線用量可小於一般電焊機電源線一半以上，例如一般電焊機電源線用22平方，變頻電焊機只需8平方，可減少攜帶之重量及購買電線成本，因變頻式電焊機比一般電焊機使用電力省50%以上。
3. 變頻電焊機比一般電焊機重量輕3倍以上，例如攜帶外出使用可以減少人員體力負擔，提高人員工作效率。
4. 變頻式電焊機焊接是直流出電，不同於一般電焊機是交流出電，而容易產生感電，造成工作人員意外傷亡。
5. 變頻電焊機內附指撥開關，標準防電擊功能，如果切在防電擊焊接效果比一般交流防電擊好焊接，可提升工作效率。

節省電力50%以上 SAVES 50% ON ENERGY COSTS

規格表 Specifications

型式 Type	定格入力電壓 Input Voltage	出力容量 Output Capacity		定格出力電流 Output Current	出力電流調整範圍 Output Current Range	定格使用率 Duty Cycle	定格負載電壓 Load Voltage	最高無負載電壓 Max. No Load Voltage	使用熔接棒徑 Welding Stick	重量 Weight	外形尺寸 (寬x深x高) Size (WxDxH)
	V	KVA	KW	A	A	%	V	V	mm	kg	mm
YSIW200	單相 Single phase 220(200)	10	7.5	160	20 ~ 160	35	27.8	63 (58)	2.0 ~ 3.2	7.8	150 x 305 x 255
YSIW400	單、三相兩用 Single / Three phase 220(200)	30	20	400	50 ~ 400	50	38	75 (70)	2.6 ~ 5.0	50	300 x 540 x 550
YSIW600	單、三相兩用 Single / Three phase 220(200)	50	35	600	75 ~ 600	50	45	85 (70)	3.2 ~ 8.0	60	300 x 640 x 550

★定格入力電壓可訂製。 Available in custom input voltage. ★產品外型尺寸、性能如有更改，恕不另通知。 Specifications are subject to change without notice due to constant improvement.

電容式植釘機

CD STUD WELDING MACHINE

產品特色 FEATURES

- 可依溶接條件調整充電電壓。
- 0.001~0.003秒的瞬間就能完全溶接，
- 快速又方便，提昇焊接效率。
- 操作容易，攜帶方便。
- 適用於鐵箱機械業、配電箱、電梯面板、帷幕牆、廚具鍋蓋、汽車板金等，屬於快速又方便的一種焊接方式。
- Adjustable charging voltage as per welding condition
- Welding occurs in 0.001~0.003 seconds, allows speed, convenience and further to improve welding efficiency
- Easy to operate, compact dimension allows convenient carrying
- Ideal solution for industries, including Power distribution panelboard, Elevator panelboard, Curtain wall, Cookware pot, Car sheet metal..etc other general applications require this welding kit

溶接外徑1.6~M8

■ YSSWS800



溶接外徑1.6~M8

■ YSSWS800U



溶接外徑1.6~M10

■ YSSWS1200



規格表 Specifications

型式 Type	入力電壓 Input Voltage	出力電流 Output Current	充電(溶接) 電壓 Charge Range	適用板厚、材質 Suitable Diameter & Material	尺寸 Size (WxDxH)	重量 Weight
	V	A	V	mm	mm	kg
立式 YSSWS800U	單相 Single phase 110	800	DC40~140	軟鋼、不銹鋼 Mild steel/Stainless steel 0.5~4 鋁、銅、黃銅 Aluminum/copper/brass 0.5~4	360x260x810	29
臥式 YSSWS800	單相 Single phase 110	800	DC40~140	軟鋼、不銹鋼 Mild steel/Stainless steel 0.5~4 鋁、銅、黃銅 Aluminum/copper/brass 0.5~4	200x420x330	24
臥式 YSSWS1200	單相 Single phase 110	1200	DC40~140	軟鋼、不銹鋼 Mild steel/Stainless steel 0.5~6 鋁、銅、黃銅 Aluminum/copper/brass 0.5~6	200x535x330	27

★定格入力電壓可訂製。 Available in custom input voltage. ★產品外型尺寸、性能如有更改，恕不另通知。 Specifications are subject to change without notice due to constant improvement.

汽車修配廠板金拉平焊接機

AC STUD WELDER DENT PULLING SYSTEM (For car body dent removal)

產品特色 FEATURES

- 時間及電流無段數位調整。
- 操作容易，攜帶方便。
- 適用汽車板金廠修補。
- Stepless digital adjustment of Welding time & Current
- Easy to operate, compact dimension allows convenient carrying
- Ideal solution for Car body dent pulling repair

■ 汽車板金用工具 Accessories



自動點焊滑槌 長度:440mm
Auto Pulling Hammer, Length: 440mm



點焊滑槌 長度:480mm
Pulling Hammer, Length: 480mm



焊槍組 線長:3M
Welding Gun, Cord Length: 3M



■ YSACSW1300

規格表 Specifications

型式 Type	入力電壓 Input Voltage	最大溶接入力 Max. Input Capacity	出力電流 Output Current	定格使用率 Duty Cycle	尺寸 Size (WxDxH)	重量 Weight
	(V)	(KVA)	(A)	%	(mm)	kg
YSACSW1300	220V單相	12.5	1300	3	400x290x780	29

★定格入力電壓可訂製。 Available in custom input voltage. ★產品外型尺寸、性能如有更改，恕不另通知。 Specifications are subject to change without notice due to constant improvement.

白鐵焊道處理機

Weld BEAD PROCESSOR

產品特色 FEATURES

- 操作簡單、安全、環保，清除焊道黑痕。
- 清除速度快、徹底，能取代機械打磨拋光。
- 不損傷鐵材，恢復不銹鋼原色及光澤。
- 鈍化表面，提高不銹鋼抗腐蝕能力。
- 使用方便，提高生產效率。
- 常溫使用、高效、低耗，除油除銹
- 同步進行，可降低成本。

- Ensure Easy Operation, Safety, Environment-Friendly & Cleanliness of Black Beads for the Welds
- Allow Cleaning Works Quickly & Thoroughly, Replaced the Works done with Mechanical Grinding Polish.
- No Damages to the stainless steel material, maintain its original shiny colour
- Improve resistance to stainless steel corrosion
- Making cleaning tasks easier, Improve production efficiency to facilitate work
- Operate the welder under the normal room temperature; Efficiency, Less Consumption in Costs is increased. Oil & Rust Removal works Simultaneously, Allows Cost Reduction.



■ YSBP10

規格表 Specifications

型式 Type	入力電壓 Input Voltage (V)	相數 Phase ∅	輸出電流範圍 Output Current range %	輸出時間範圍 Output time range S	冷卻方式 Cooling	尺寸 Size (WxDxH) mm	重量 Weight kg
YSBP10	110	1	33-99	1~∞	Fan cooled	155x300x285	12.5

電池壽命檢測器

BATTERY TESTER



■ BTT107S-12V

產業用·配電用乾式變壓器

INDUSTRIAL DRY TRANSFORMER

- 屋內、屋外型、H級 填充型乾式變壓器
Indoor & Outdoor Style, H Class, Filled-type Dry transformer

- 降低噪音分貝90%以上 Noise is reduced by more than 90%
- 散熱效果好 Good in heat dissipation
- 防止火災發生 Avoid Fire
- 無油式變壓器產生的二次污染 No oil pollution



YS-DT52
壁掛式H級填充型
乾式變壓器
Hanging Type, H Class
Filled-type Dry transformer



YS-DT54
落地式H級填充型
乾式變壓器
Flooring Type, H Class
Filled-type Dry transformer



YS-DT53
壁掛式H級填充型
乾式變壓器
Hanging Type, H Class
Filled-type Dry transformer



產業用·配電用乾式變壓器

INDUSTRIAL DRY TRANSFORMER

YUHSIN

活動型 Movable type



YS-DT14

三相50~300KVA乾式變壓器
(附電壓表及電流表、電壓調整器、電流調整器)
Three-phase 50~300KVA Dry transformer
includes voltmeter, ammeter, voltage regulator, current
regulator & NFB. (Optional)

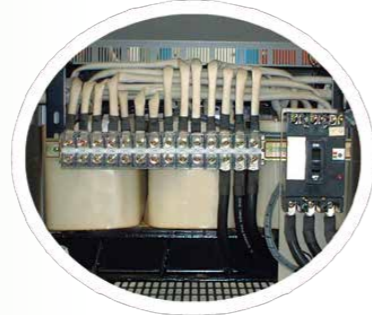

活動型 Movable type



YS-DT16

三相10~150KVA乾式變壓器(附無熔絲開關)
Three-phase 10~150KVA Dry transformer
includes NFB

活動型 Movable type



YS-DT12-3000-3

三相200~1000KVA乾式變壓器
Three-phase 200~1000KVA Dry transformer

活動型 Movable type



YS-DT12

三相10~150KVA乾式變壓器
Three-phase 10~150KVA Dry transformer

產業用·配電用乾式變壓器

INDUSTRIAL DRY TRANSFORMER

落地式 Flooring type



YS-DT13-4500-3

三相150~1000KVA乾式變壓器
Three-phase 150~1000KVA
Dry transformer



落地式 Flooring type



YS-DT13

三相200~1000KVA乾式變壓器
Three-phase 200~1000KVA
Dry transformer

壁掛式·落地式 Flooring type, Hanging type



YS-DT13

三相10~150KVA乾式變壓器
Three-phase 10~150KVA Dry transformer

產業用・配電用乾式變壓器

INDUSTRIAL DRY TRANSFORMER

規格表 SPECIFICATION

		單相 Single Phase	三相 Three Phase
周圍溫度 Ambient Temp		0~40°C	0~40°C
周圍濕度 Humidity		30~95%	30~95%
海拔高度 Sea level		1000M以下	1000M以下
周波數 Frequency		50/60HZ±5%	50/60HZ±5%
輸入電壓(V) Pri. Volt.		100,110,115,200,220,380,400,415,440	200,220,230,380,400,415,440
輸出電壓(V) Sec. Volt.		100,110,115,200, 220, 380,400,415,440	200,220,230,380,400,415,440
效率 Efficiency		96%以上	96%以上
電壓調整率 Volt. Regulation		2.5%以下	2.5%以下
絕緣種別 Insulation Class		B, F, H CLASS	B, F, H CLASS
絕緣電阻 Insulation R		1000MΩ	1000MΩ
絕緣耐壓 Insulation Voltage		2100V/1 minute(P-S)	2100V/1 minute(P-S)
感應電壓 Induced Voltage		180HZ, 2xVOLT, Test 20秒	180HZ, 2xVOLT, Test 20秒

外觀尺寸規格 SPECIFICATION

■ YS-DT13 / YS-DT12 TYPE 標準落地壁掛型/標準附輪子型 Standard Flooring / Hanging Type, With Wheels

型式 Type	容量 Capacity KVA	相數 Phase	寬 (W) mm	深 (D) mm	高 (H) mm	固定腳/輪子 H1/H2 mm	孔距寬 W1 mm	孔距深 D1 mm	孔尺寸 Hole C mm	重量 Weight Kg
-50-1	3-5	1	320	280	280	25/70	250	260	ø13	25-40
-100-1	7.5-10	1	360	340	330	25/70	260	320	ø13	55-70
-200-1	15-20	1	450	400	350	25/70	350	380	ø13	80-90
-400-1	25-40	1	500	450	500	35/90	370	430	ø13	145-185
-50-3	5-7.5	3	350	300	300	25/70	250	280	ø13	58-72
-100-3	10-15	3	420	330	350	25/70	310	310	ø13	72-95
-200-3	20-25	3	450	400	400	25/70	330	380	ø13	120-140
-300-3	30-37.5	3	550	450	500	35/90	420	400	ø13x25L	145-175
-400-3	40-75	3	650	480	550	45/90	480	420	ø13x25L	180-290
-1000-3	100-150	3	800	590	650	50/105	580	540	ø13x25L	400-480
-2000-3	200-250	3	850	630	730	55/105	600	580	ø15	630-750
-3000-3	300	3	950	700	800	55/105	730	650	ø15	860

產業用乾式變壓器

INDUSTRIAL DRY TRANSFORMER

■ 容量、電壓、客戶可提供訂製 We accept custom capacity, voltage, orders from customers.



YS-DT01-2000-3
三相50~300KVA H級自藕乾式變壓器
Three-phase 50~300KVA H-class Auto Transformer



YS-DT01-3000-3
三相50~300KVA H級自藕乾式變壓器
Three-phase 50~300KVA H-class Auto Transformer



YS-DT01-3500-3
三相50~350KVA H級自藕乾式變壓器
Three-phase 50~350KVA H-class Auto Transformer



YS-DT11-3500-3
三相50~350KVA H級乾式變壓器
Three-phase 50~350KVA H-class Transformer



YS-DT42-2
二次低電壓變壓器
Secondary Low-voltage Transformer

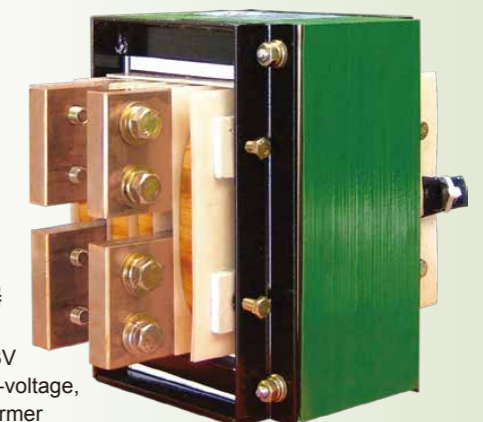

YS-DT41
H級乾式變壓器
(二次低壓)
15KVA/ø220V/3V
Secondary Low-voltage,
H-class Transformer

產業用乾式變壓器

INDUSTRIAL DRY TRANSFORMER

■ 容量、電壓、客戶可提供訂製 We accept custom capacity, voltage, orders from customers.



YS-DT11-5-1

單相0.5~5KVA乾式變壓器
Single-phase 0.5~5KVA Transformer



YS-DT46-10

電容式熔接機充電用變壓器
Capacitor Discharge Welder Use Transformer
1KVA-15KVA

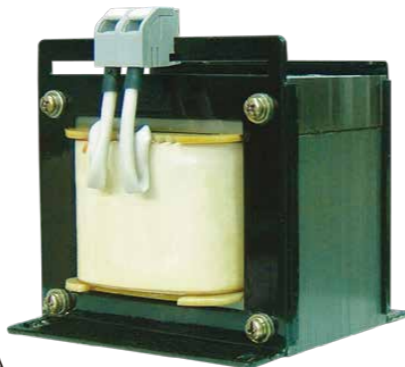

YS-DT21-15-1

H級乾式電感器
H class Reactor
1.5KVA/ø220V/6A



YS-DT46-500

電容式熔接機充電用變壓器
Capacitor Discharge Welder Use Transformer
20KVA-50KVA

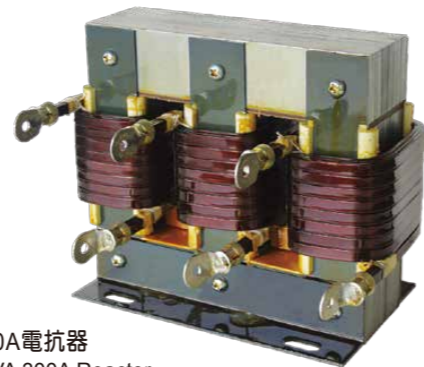

YS-DT21

三相8.3KVA 300A電抗器
Three phase 3KVA 300A Reactor

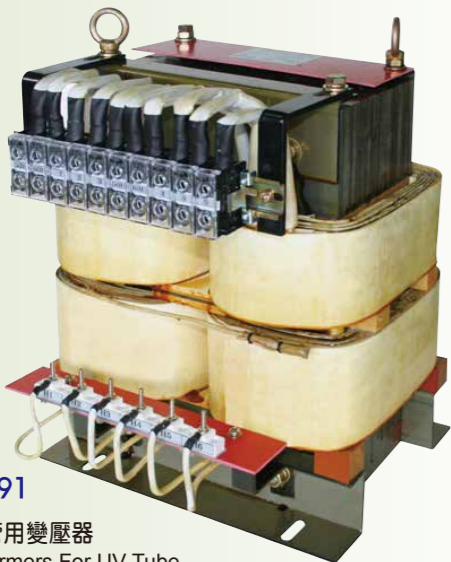

YS-DT91

UV燈管用變壓器
Transformers For UV Tube



YS-DT92

UV燈管用電抗器
Reactor For UV Tube

油浸式產業用變壓器

INDUSTRIAL USE OIL IMMERSED TRANSFORMER

總號 CNS-598

類號 C 4010

油浸式項目 PRODUCTS

- 特殊用變壓器
Special Purpose Transformers
- 爐專用變壓器
Melting Furnaces Transformers
- 高週波加熱用變壓器
High-frequency Induction Heating Transformers
- 各式電壓、容量可訂製
All Kind of Transformers
Designs are Welcome



YS-DO51

高週波、感應加熱專用變壓器
Transformers for high-frequency, induction heating
200KVA 三相(Three phase) 220V/9KV

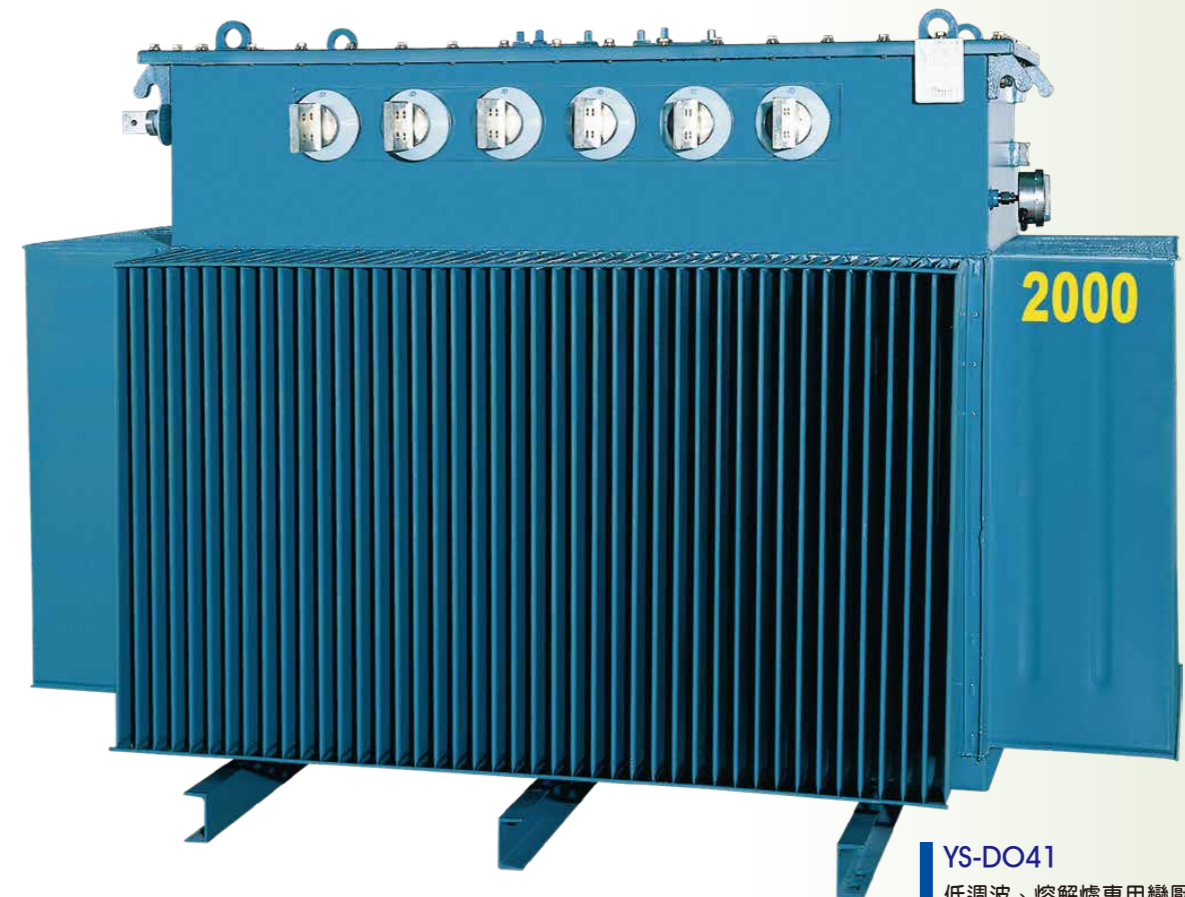

YS-DO41

低週波、熔解爐專用變壓器
Transformers for Low-frequency heating,
Melting Furnaces 2000KVA 三相(Three phase)
11.4KV / 95-137-158-179-200V

油浸式試驗用高低壓變壓器

TESTING PURPOSE OF HIGH-LOW-VOLTAGE OIL-COOLED TRANSFORMER

NIHSHIN



YS-DO74
交流耐壓試驗台
AC withstand voltage tester
10KVA 1Ø INPUT 220V
OUTPUT 60KV
電壓可訂製 Voltage custom-made



YS-DO300
電源變壓器
Power supply transformer
220V / 380V / 415V / 440V



◀◀
配電盤匯流排溫昇試驗機
TEMPERATURE TESTING MACHINE
FOR DISTRIBUTION BUS
YS-VR-65-3
容量65KVA 3Ø
AC 220V/6000A



▶▶
配電盤匯流排溫昇試驗機
TEMPERATURE TESTING MACHINE
FOR DISTRIBUTION BUS
YS-VR-35-1
容量35KVA 1Ø
AC 220V/8000A

各式交流熔接變壓器

RESISTANCE AC WELDING TRANSFORMER



YS-DW11-750
交流熔接變壓器
AC Welding Transformer
75KVA-100KVA



YS-DWK1-750
日本木村(專用)交流熔接變壓器
JAPAN KIMURA Type AC Welding Transformer
75KVA-100KVA

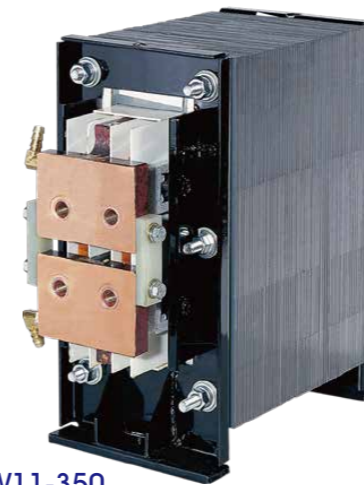

YS-DW11-350
交流熔接變壓器
AC welding transformer
35KVA-50KVA

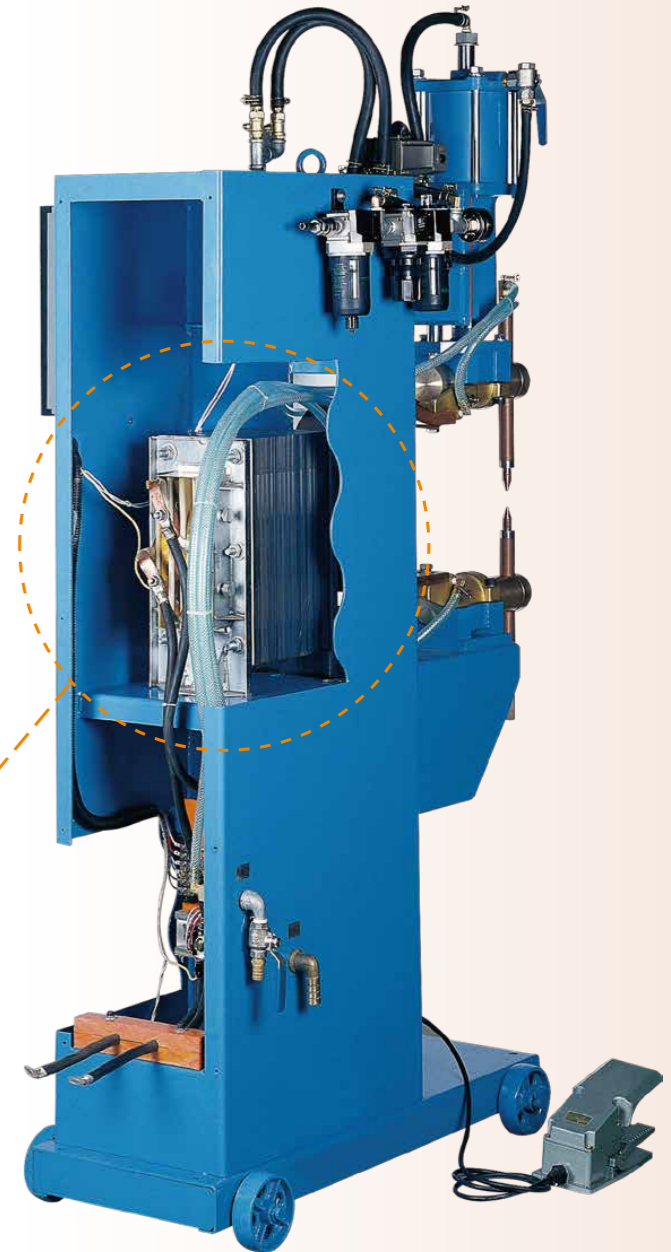

各式交流熔接變壓器

RESISTANCE AC WELDING TRANSFORMER

▶ 大陸專利號 China Patent No.: ZL15453.4

▶ 台灣專利號 Taiwan Patent No.: 160031

▶ 大陸專利號 China Patent No.: ZL98.2.40390.9

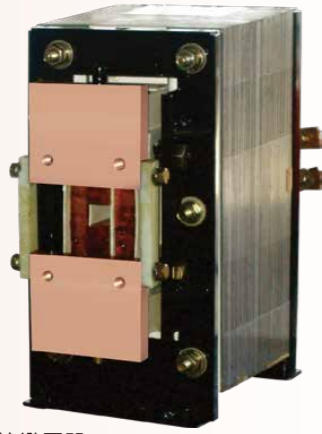

YS-DWJ1-350

日本中央(專用)交流熔接變壓器
JAPAN CHUO SEISAKUSHO TYPE
AC Welding Transformer
35KVA-50KVA

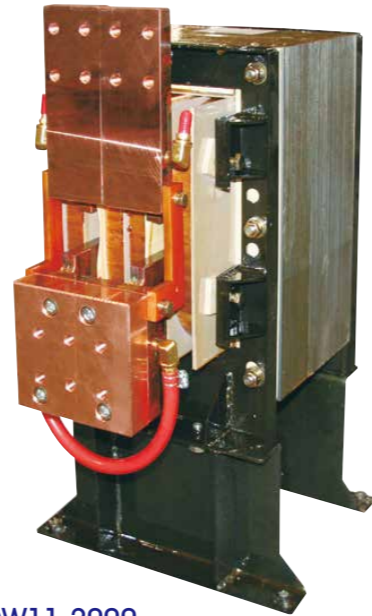

YS-DW11-2000

交流熔接變壓器
AC Welding Transformer
200KVA

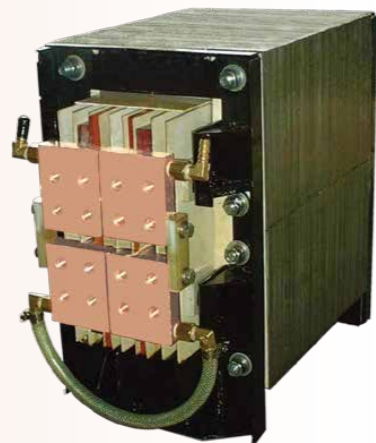
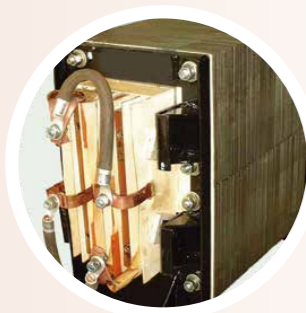

YS-DW11-1500

交流熔接變壓器
AC Welding Transformer
150KVA-200KVA

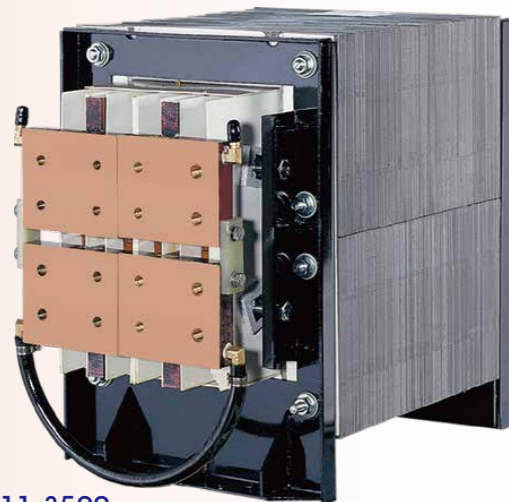

YS-DW11-3500

交流熔接變壓器
AC Welding Transformer
350KVA-500KVA



YS-DW11-4800

交流熔接變壓器
AC Welding Transformer
500KVA

產業抵抗熔接機械專用變壓器

RESISTANCE WELDING TRANSFORMERS FOR MANUFACTURING



YS-DW12

熔接機變壓器
Welding Transformer
35KVA-50KVA



YS-DW12

熔接機變壓器
Welding Transformer
150KVA-300KVA

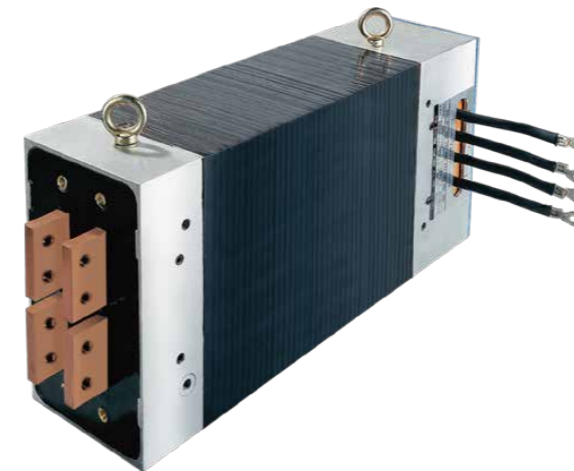

YS-DWY2

二次平行熔接機變壓器(2組)
Welding Transformer
100KVA-200KVA

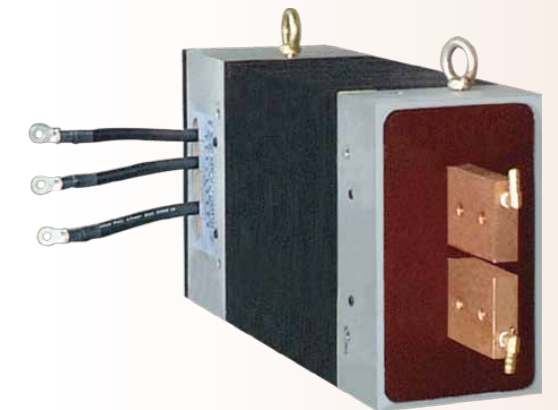

YS-DWY2

二次平行熔接機變壓器(1組)
Welding Transformer
50KVA-200KVA

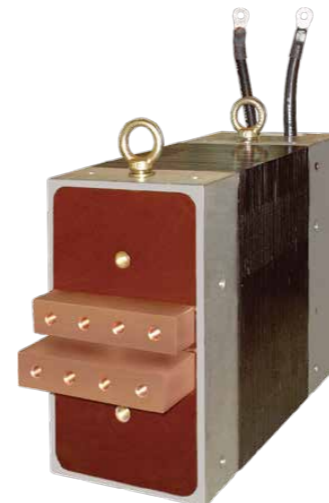

YS-DWB2

多用途熔接機變壓器
Multi-purpose Welding Transformer
75KVA-150KVA



YS-DWB2

多用途熔接機變壓器
Multi-purpose Welding Transformer
100KVA-200KVA



YS-DWB2

多用途熔接機變壓器
Multi-purpose Welding Transformer
100KVA-150KVA

各式單相入力，二次出力全波整流熔接變壓器

SINGLE PHASE DC WELDING TRANSFORMER

各式三相入力，二次出力全波整流熔接變壓器

SINGLE, THREE-PHASE DC WELDING TRANSFORMER

YUHSIN

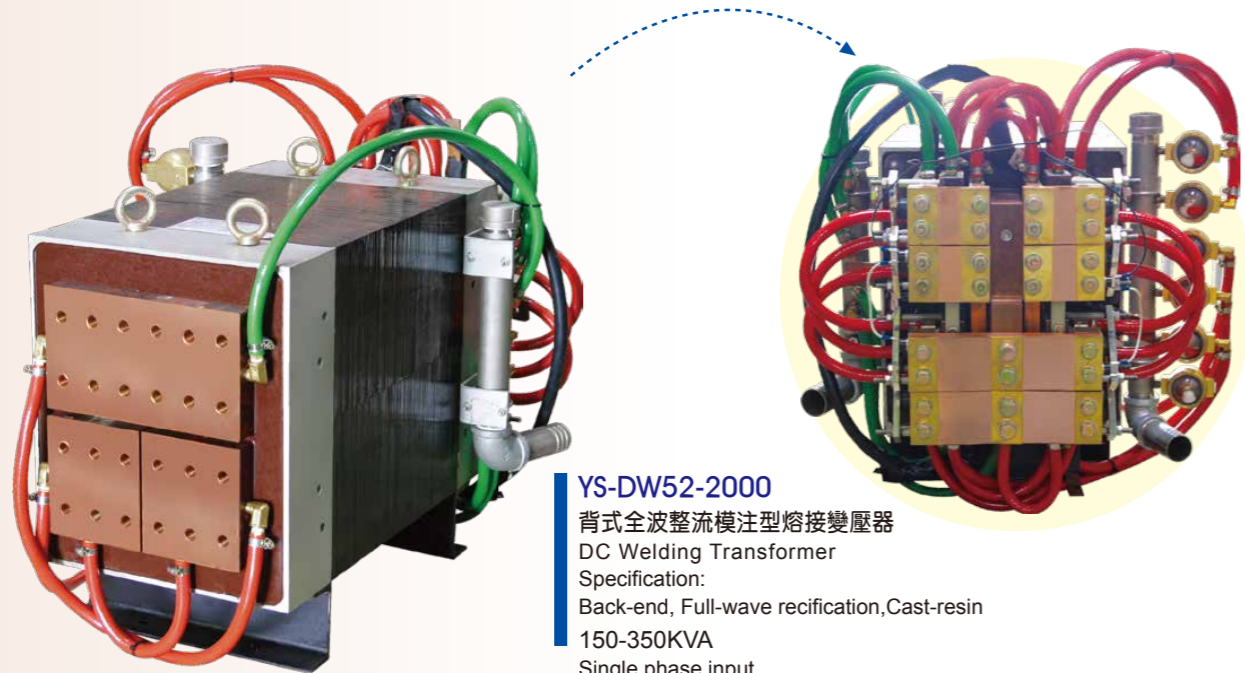

YS-DW52-2000
背式全波整流模注型熔接變壓器
DC Welding Transformer
Specification:
Back-end, Full-wave recification, Cast-resin
150-350KVA
Single phase input
▶ 大陸專利號 China Patent No.: ZL15453.4
▶ 台灣專利號 Taiwan Patent No.: 160031

YS-DW52-350
背式全波整流模注型
熔接變壓器
DC Welding Transformer
Specification:
Back-end, Full-wave
recification, Cast-resin
單相入力35-100KVA
Single phase input



▶ 大陸專利號 China Patent No.: ZL19346.X
▶ 台灣專利號 Taiwan Patent No.: 169287

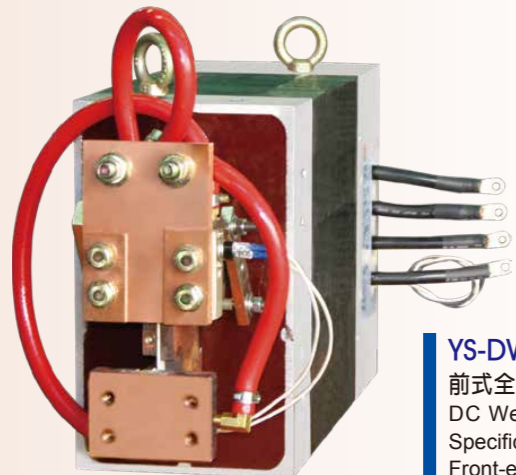

YS-DW42-350
前式全波整流熔接變壓器
DC Welding Transformer
Specification:
Front-end, Full-wave recification, Cast-resin
單相35KVA-150KVA



YS-DW42-5000
前式全波整流熔接變壓器
DC Welding Transformer
Specification:
Front-end, Full-wave recification, Cast-resin
單相500KVA (未附整流子)

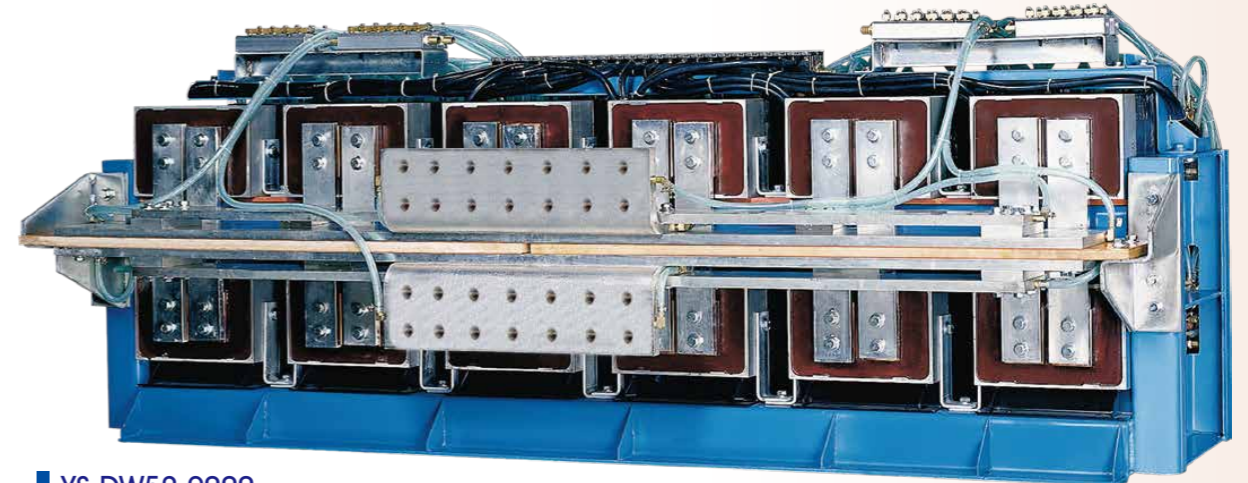

YS-DW52-9000
背式整流型熔接變壓器
DC Welding Transformer(Back-end)
柵板焊接機械專用
Grating Welding Machines-use
900KVA三相入力 Three phase input

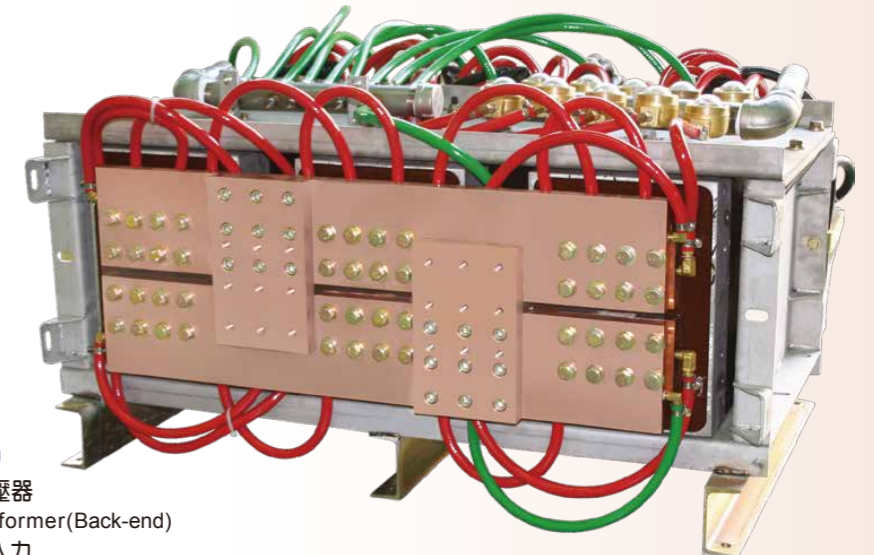
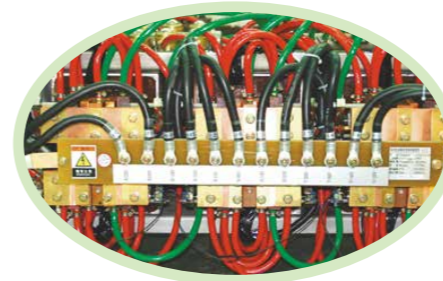

YS-DW52-4500
背式整流型熔接變壓器
DC Welding Transformer(Back-end)
350-750KVA三相入力
Three phase input

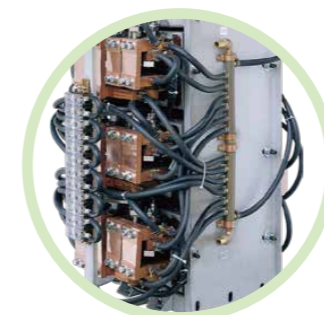

電源端子及冷卻水管集中裝置
Power Terminal and Cooling
Water Collector



YS-DW52-1000
背式整流型熔接變壓器
DC Welding Transformer(Back-end)
100-300KVA三相入力
Three phase input
▶ 大陸專利號 China Patent No.: ZL18591.7
▶ 台灣專利號 Taiwan Patent No.: 170425

變頻式二次出力全波整流熔接變壓器

INVERTER DC WELDING TRANSFORMER

YUHSIN



YS-DWH2-500101
變頻式直流熔接變壓器
Inverter DC Welding Transformer
50KVA 1200Hz



YS-DWH2-500104
變頻式直流熔接變壓器
Inverter DC Welding Transformer
50KVA 1200Hz

變頻式熔接變壓器規格 Inverter Welding Transformer Specifications

型式 Type		YS-DWH2-500101	YS-DWH2-1000101	YS-DWH2-1500103
定格容量 Rated Capacity at 50% Duty Cycle	KVA	50	100	150
定格一次電壓 Primary Voltage	V	310	620	620
週波數 Frequency	Hz	1200	1200	1200
最大二次電流 Maximum Secondary Current	A	20,000	30,000	40,000
二次電壓 Secondary Voltage	V	9.7	11.9	7.75-8.86
卷數比 Turn Ration		32	52	40-30
冷卻水量 Cooling Water	L/min	6	10	10
使用率 Duty Cycle	%	5	5	5
絕緣階級 Insulated Class		F	F	F
概略質量 Approximate Mass	Kg	33.2	61	130

變頻式二次出力全波整流熔接變壓器

INVERTER DC WELDING TRANSFORMER

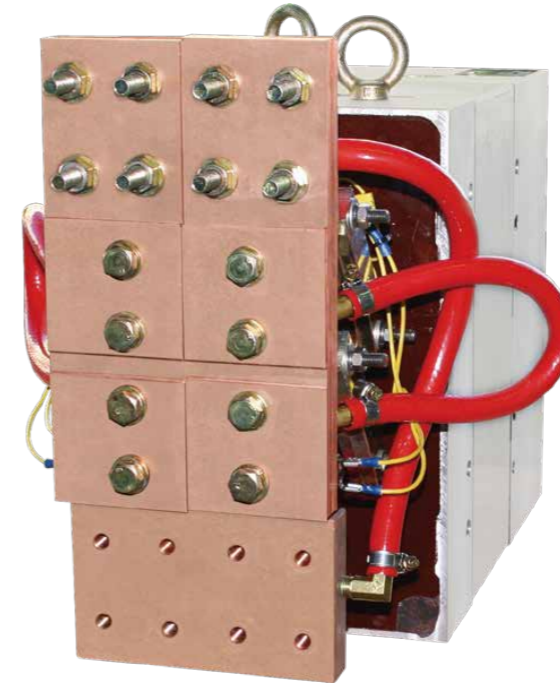

YS-DWH2-1500102
變頻式直流熔接變壓器
Inverter Welding Transformer
150KVA 1200Hz

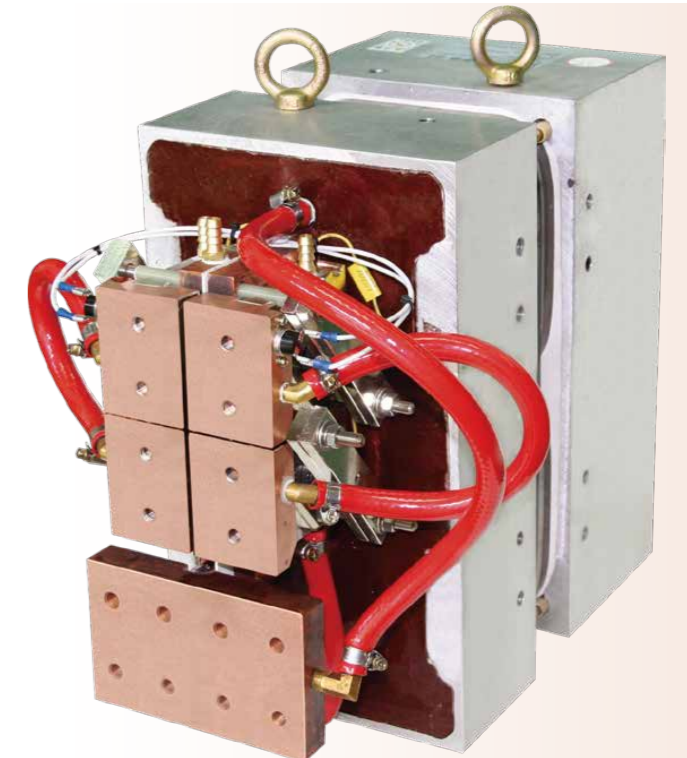

YS-DWH2-1500103
變頻式直流熔接變壓器(輪焊用)
Inverter Welding Transformer (For SEAM welder use)
150KVA 1200Hz

變頻式二次出力交流熔接變壓器

INVERTER AC WELDING TRANSFORMERS



YS-DWG2-1060101
變頻式交流熔接變壓器(飲料罐專用)
Inverter Welding Transformer (For canned goods manufacturing use)
106KVA 300~900Hz



YS-DWG2-500101
變頻式交流熔接變壓器
Inverter Welding Transformer
35KVA-100KVA 300~1000Hz

直流電源機

DC POWER SUPPLY

直流電源機

DC POWER SUPPLY

YUHSIN

- 1 專業製造各式直流電源機可廣泛適用於半導體工廠、污水淨水廠、電鍍廠、PC板線路電鍍用、國防專用及特殊產業用等。
- 2 目前國內直流電源機乾式容量最大製造廠，有多項專利設計。
- 3 採用220°C絕緣耐熱材料、內部設計水冷及風冷冷卻系統，提高使用壽命。
- 4 可媲美歐美日等先進國家相同機械的特性及品質，不但體積小、好維修，改善過去油浸式構造之體積大，不易維修的缺點。
- 5 穩定度高，穩壓特性佳、低連波雜訊，俱逆向保護裝置及定電壓與定電流功能。

- 1 This is a special purpose machine with applications in water fab factories, pollution treatment plants, electroplating shops, circuit board electroplating factories, and other industries where DC generator are used.
- 2 The leading manufacturer with the most comprehensive range of DC power generators in Taiwan. Many patents & copy rights registered.
- 3 220°C Heat-resistant materials are used in conjunction with water & air cooling circulation for maximum operating life.
- 4 Capabilities and quality comparable to the finest machines available from Japan and the West. Compact size and easy maintenance, resolving the major problems associated with earlier hydraulic designs.
- 5 Extremely dependable operations with highly stable pressure and minimal interference. Counter-rotating protector and voltage and current stabilizing systems.

➤ 台灣專利號 Taiwan Patent No.: 090212051

➤ 大陸專利號 China Patent No.: ZL02218419.8



YS-DP11
DC 2~15V / 3000A



YS-DP11
DC 1~30V / 20000A

■ 國防戰鬥機、直升機起動專用 DC Starter for Fighter Aircraft



YS-DP41
DC 28.5V / 1500A



YS-DP41
DC 28.5V / 600A

直流電源機

DC POWER SUPPLY

交流電源機

AC POWER SUPPLY

NIHSHIN



YS-DP21
DC 1~50V / 500A
DC 5~500V / 50A



YS-DP21
DC 10000V / 2A



YS-DP21
DC 2~150V / 40A



YS-DP21
DC 200V / 40A



YS-AP11
容量25KVA 1ø
AC 380V/12V



YS-AP13
容量9KVA 3ø
Input 220 / 380V
Output 週波數50~1000Hz
Output 電壓1~400V
變頻三相交流電源機
Inverter AC Power Supply



YS-DP21
DC 70V / 100A (2組)



全自動交流穩壓器

FULLY-AUTOMATIC AC VOLTAGE REGULATOR



YS-PS31000
油浸式全自動交流穩壓器
Fully-automatic Oil-immersed
AC Voltage Regulator



YS-PS102
全自動交流穩壓器 (單相系列)
Fully-automatic AC Voltage Regulator (single phase)
1ø2KVA~30KVA 100V, 110V, 200V, 220V, 380V, 415V, 440V



集中配線端子台
The Center of Power
Distribution Terminal Block



YS-PS305

全自動交流穩壓器 (三相系列)
Fully-automatic AC Voltage Regulator (Three phase)
3ø5KVA~150KVA 200V, 220V, 380V, 415V, 440V

技術規範 Technical Specifications

■ 穩壓範圍 Voltage Fluctuation	額定輸入電壓之±15% ±15% of input voltage
電壓 Voltage	3ø 200V, 220V, 380V, 415V, 440V
穩壓率 Voltage Fluctuation	±1.5%以內 ±1.5% of input voltage
輸出可調 Adjustable Output	±10%可調 ±10%
效率 Operating Efficiency	95%以上 Over 95%
反應時間 Reaction Time	≤0.1秒(5週) ≤0.1 sec (5 cycles)
工作頻率 Operating Frequency	50/60Hz±5%
超載能力 Overload Capability	150%(10秒)300%(3秒) 150% (10 sec.), 300% (3 sec)
波形失真 Wave Distortion	正弦波不失真 No loss of sine wave
工作環境 Operating Environment	溫度0°C~40°C/濕度20%~90% 0°C to 40°C, 20-90% humidity
散熱方式 Heat Dissipation	油浸自冷式 Oil-cooled, self-cooling

PS - 系列

型號 MODEL	容量 Capacity KVA	型號 MODEL	容量 Capacity KVA	型號 MODEL	容量 Capacity KVA
102	2	320	20	3350	350
103	3	330	30	3400	400
105	5	345	45	3500	500
107	7.5	360	60	3600	600
110	10	375	75	3750	750
115	15	3100	100	31000	1000
120	20	3120	120	31250	1250
130	30	3150	150	31500	1500
305	5	3200	200	32000	2000
307	7.5	3250	250	32500	2500
310	10	3300	300	33000	3000
315	15				

☆特殊規格歡迎訂做，規格若有變動，恕不另行通知。
Custom requirement is welcome
Specifications are subject to change without prior notice due to constant improvements.

電容式熔接用變壓器

CAPACITOR DISCHARGE WELDING TRANSFORMER

產業熔接機械專用變壓器

WELDING TRANSFORMERS FOR MANUFACTURING

YUHSIN

品質穩 · 輕量化 · 高效率 · 種類多 · 交貨迅速
 Innovation, Quality, Efficient, Comprehensive Range & Quick Delivery



YS-DW21-100
 電容式熔接用變壓器
 Capacitor Discharge Welding Transformer
 10KVA-25KVA

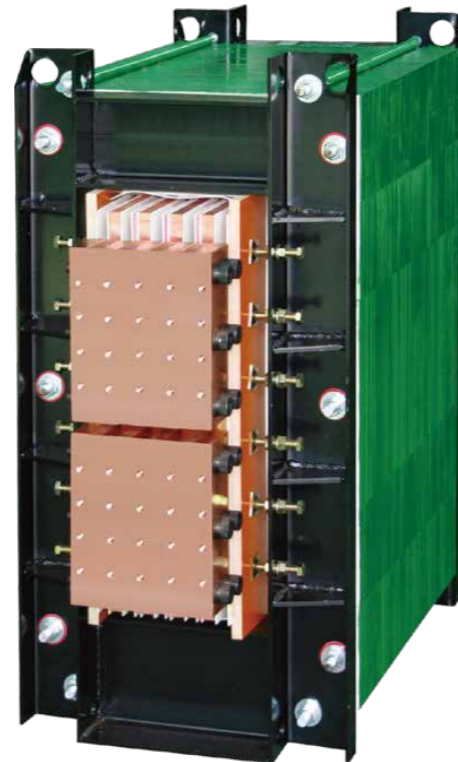

YS-DW21-300
 電容式熔接用變壓器
 Capacitor Discharge Welding Transformer
 30KVA-45KVA

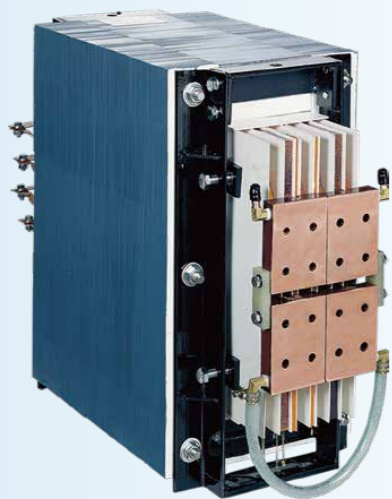

YS-DW21-60
 電容式熔接用變壓器
 Capacitor Discharge Welding Transformer
 6KVA-9KVA

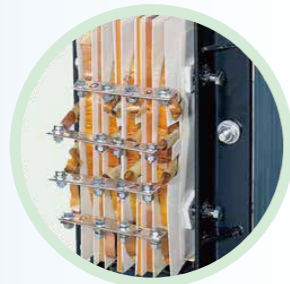

YS-DW21-30
 電容式熔接用變壓器
 Capacitor Discharge Welding Transformer
 3KVA-5KVA



YS-HA-50-2
 手提式抵抗熔接機
 Portable Resistance Welder
 35KVA-75KVA

適用於排油煙機、流理台、
 廚房器具、OA辦公傢具之
 專業生產工廠
 Application: Smoke exhaust
 electric stove, Kitchen sink,
 kitchen cabinet, kitchen
 utensil & OA office furniture



YS-MO-100-1
 手提式抵抗熔接機
 Portable Resistance Welder
 100KVA-200KVA

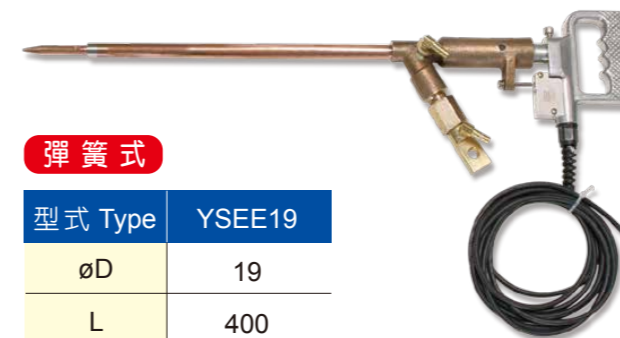

彈簧式

型式 Type	YSEE19
øD	19
L	400

註：如有特殊規格，歡迎訂製。
 If you need specific specs, welcome to order custom-made.

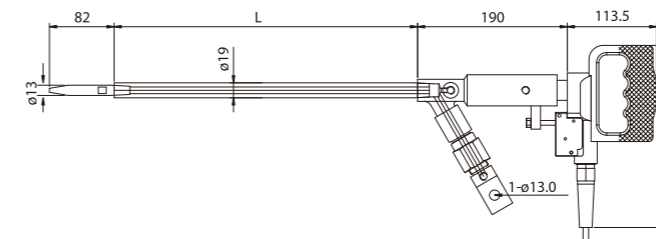

手提式

型式 Type	YSEH19	YSEH25
øD	19	25
L	690	690

註：如有特殊規格，歡迎訂製。
 If you need specific specs, welcome to order custom-made.

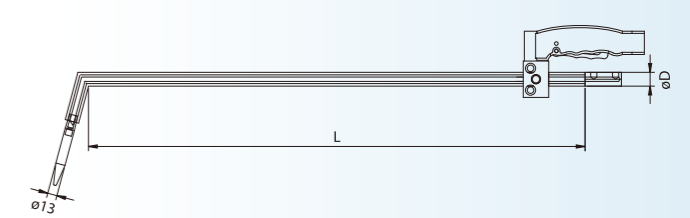

產業熔接機械專用變壓器

WELDING TRANSFORMERS FOR MANUFACTURING

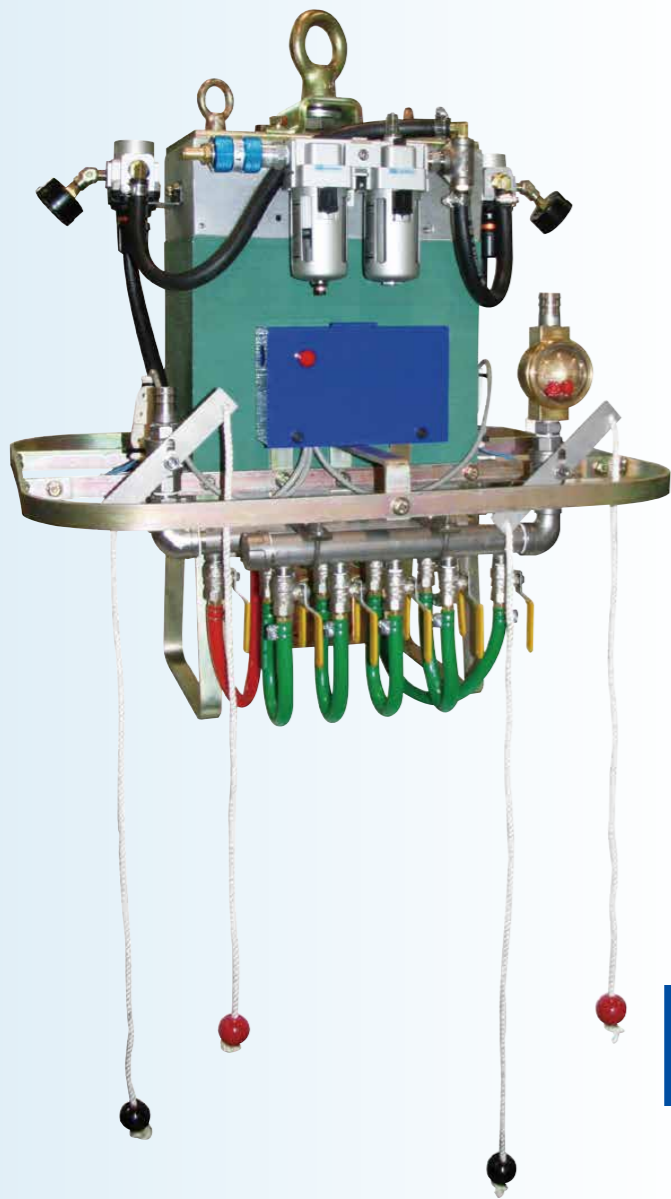

- 實現緊密小型化的目標
Realization of the compact dimension
- 熱容量充分使用率高
Abundant hot capacity, allows high duty cycle.
- 耐通電衝擊性強
Able to bear strong current.
- 機械和電器安全性高
Machinery and electric safety are high.

YS-DW62-01500
移動式熔接變壓器
Portable Welding Transformers
1φ 150KVA

型式 Type	額定容量 Rated Capacity KVA	額定週波數 Rated Frequency Hz	最高二次電壓 Secondary Voltage V	冷卻水量 Cooling water supply L/MIN	重量 Weight Kg	二次電纜負荷條件 Secondary cable load			容量 Capacity		
						種類 Kind	斷面積 Square measure mm ²	長度 Length m	最大熔接電流 Max. Welding current A	最大入力 Max. Input capacity KVA	使用率 Rate cycle %
DW62-01250	125	50 60	22.2 23.5	5	185	水冷卻 Water Cooling	200	2.5	16,000	355 380	6.2 5.4
DW62-01500	150	50 60	25.0 28.5	6	200	水冷卻 Water Cooling	200	2.5	18,000	450 510	6.0 4.5
DW62-02000	200	50 60	28.6 33.3	6	225	水冷卻 Water Cooling	200	2.5	20,000	575 670	6.0 4.5
DW62-02500	250	50 60	25.0 26.7	6	270	水冷卻 Water cooling	200	2.5	18,000	450 480	16.0 14.0

移動式熔接機安裝配置 Portable Welder Installment And Disposal

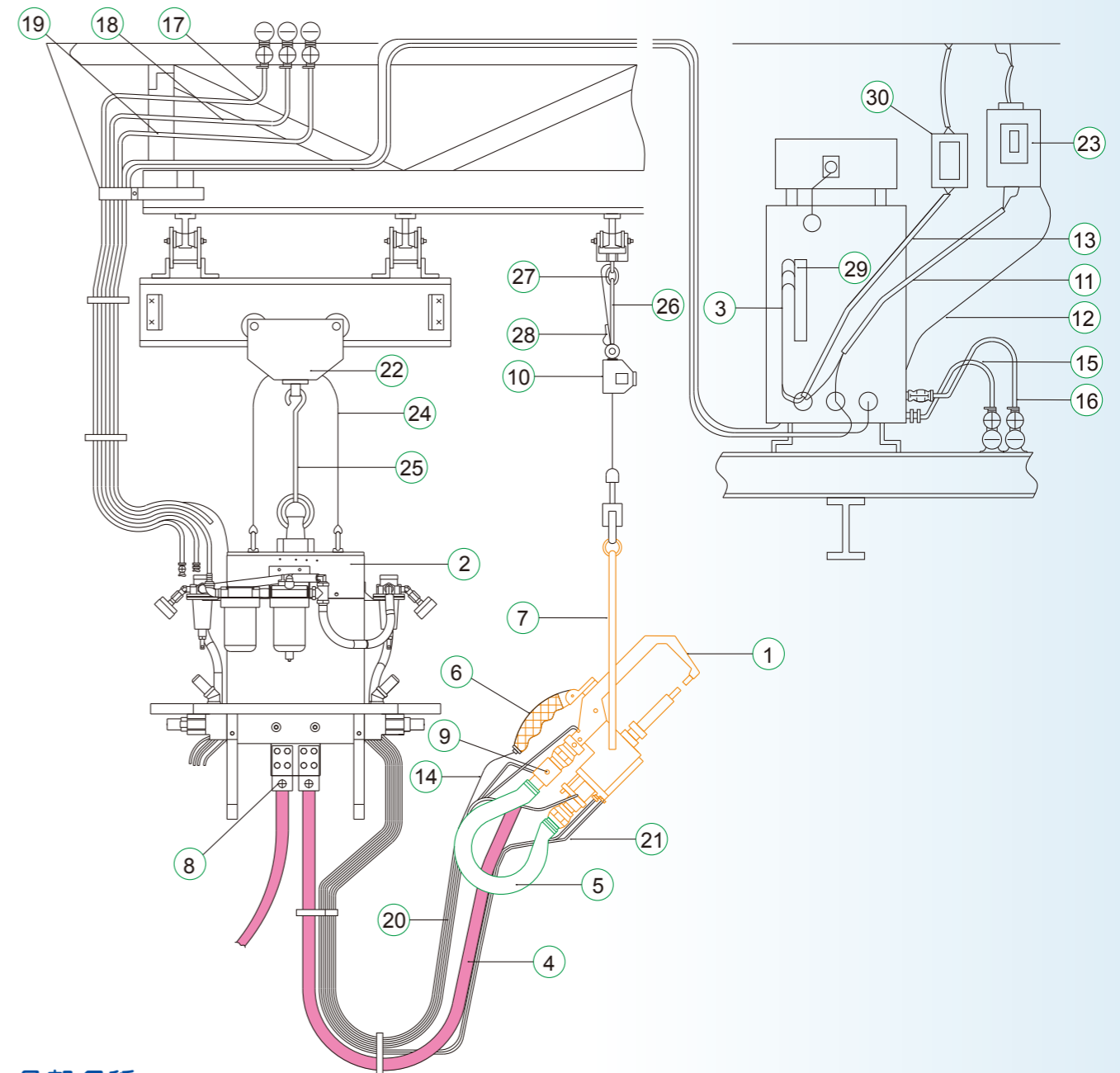

各部名稱 Part Name

1 移動電極臂 Electrode arm	11 一次側電纜 Primary Cable	21 空壓軟管 Air Pressure Hose
2 移動式變壓器 Portable Welding Transformer	12 接地線 Earth Wire	22 平面手推車 Plain Trolley
3 時間控制器 Welding Control Unit	13 電磁閥電源電纜線 Solenoid Valve Cable	23 主斷路器 Main Breaker
4 水冷卻電纜 Secondary Cable	14 握柄啟動控制線 Startup Cable	24 變壓器安全索 Safety Rope of Transformer
5 補助電纜 Auxiliary cable	15 SCR冷卻管 SCR Water Cooled Hose	25 變壓器吊金具 Balance Hanger of Transformer
6 啟動握柄 Startup Handle	16 SCR冷卻管 SCR Water Cooled Hose	26 平衡器吊具 Balance Hanger
7 臂吊具 Hanging Rod of Torch	17 變壓器冷卻管 Water Cooled Hose of Transformer	27 鋼環 Steel Ring
8 水冷卻電纜端子 Water Cooled Cable Terminal	18 變壓器冷卻管 Water Cooled Hose of Transformer	28 平衡器安全索 Safety Rope Balancer
9 焊槍側固定螺栓 Torch Bolt	19 空氣軟管 Air Pressure Hose	29 外部端子台 External Terminal
10 彈簧平衡器 Spring Balancer	20 焊槍冷卻軟管 Water Cooled Hose of Torch	30 電磁閥電源斷路器 Solenoid Valve Breaker

二次電纜

SECONDARY CABLE

二次電纜結線圖 Connection of the secondary cable

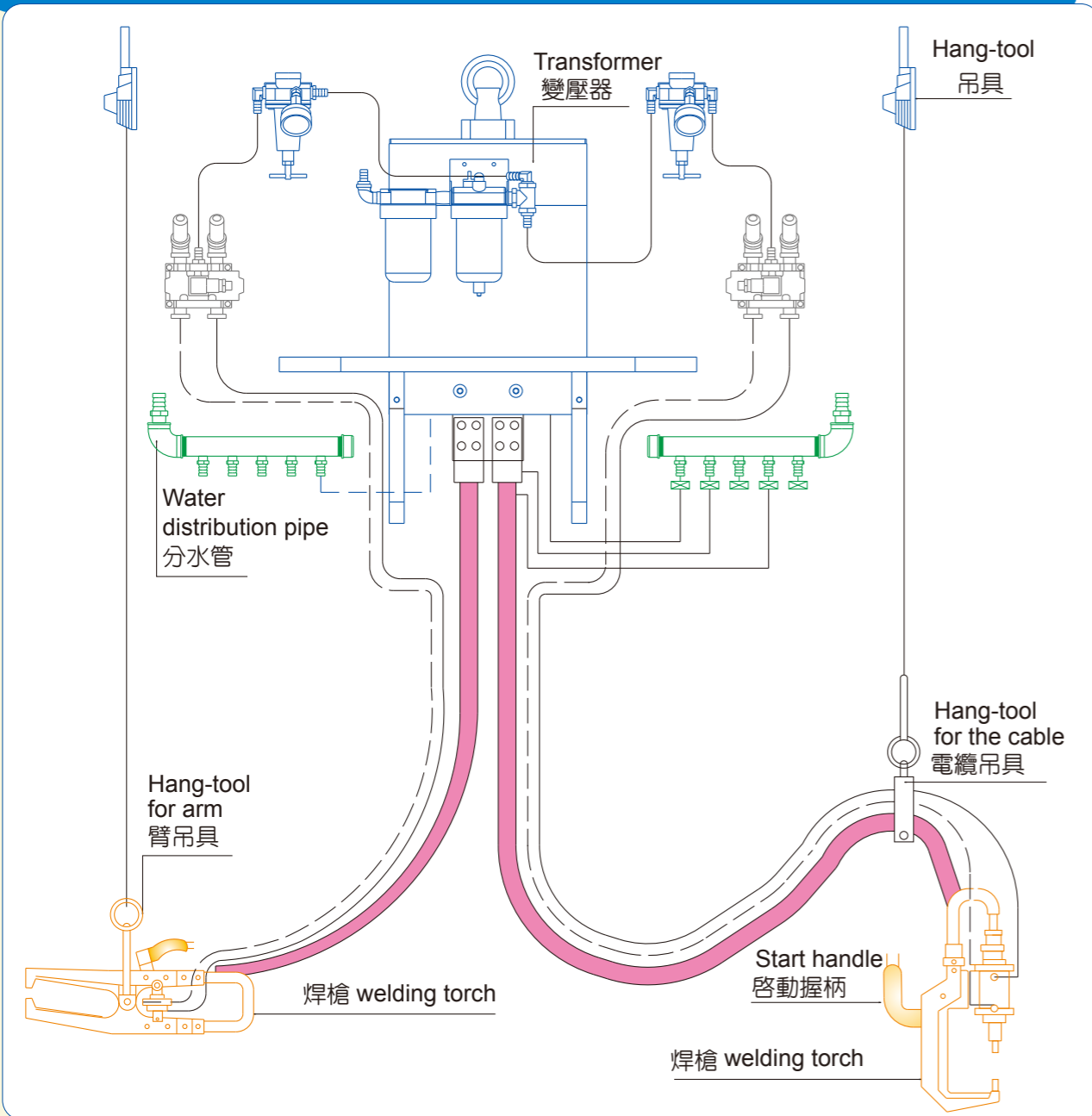

水冷卻電纜端子附件 Accessories For Secondary Cable



水冷卻電纜端子絕緣螺栓
Secondary cable-terminal bolt with insulator



變壓器二次端子絕緣螺栓
Transformer-terminal bolt with insulator

水冷卻電纜與變壓器接續銅板 Secondary Cable And Transformer Connection Copper Plate

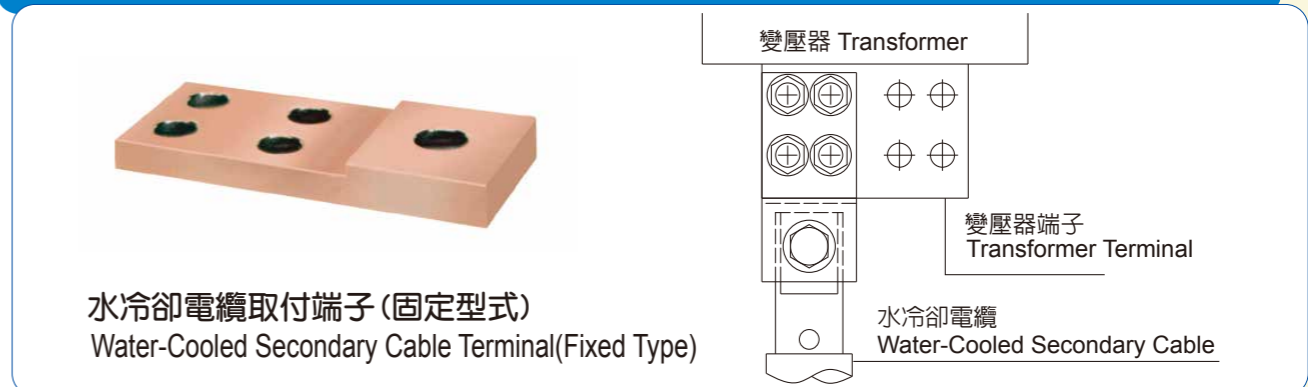

<p>C-259/150mm²~200mm²~200mm</p>	<p>C-258E/150mm²~200mm²~200mm</p>	<p>C-256/150mm²~200mm²~200mm²</p>
<p>Q-332/250mm²</p>	<p>C-343/250mm²</p>	<p>C-344/250mm²</p>

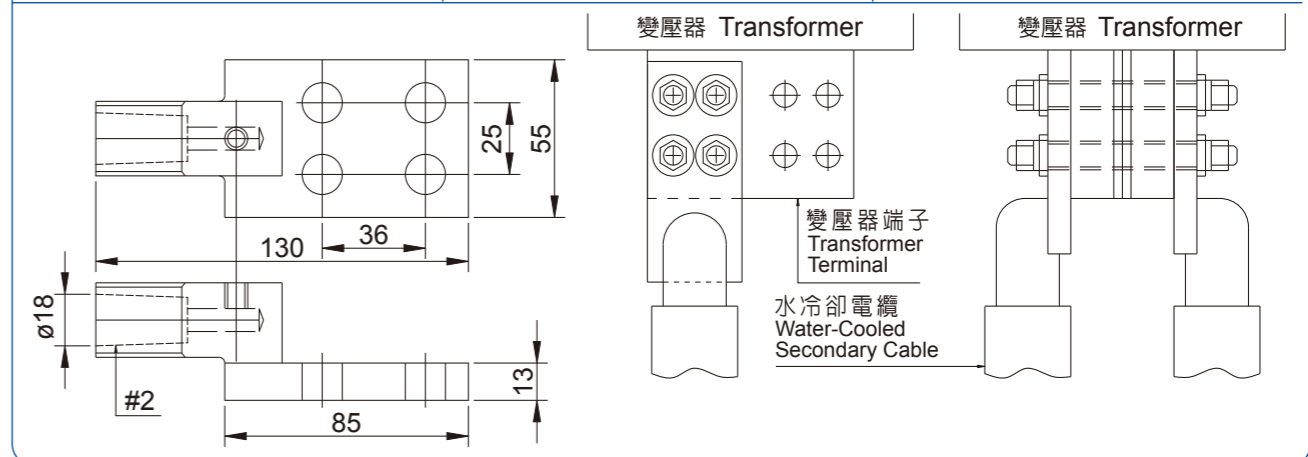

懸吊式點焊機

PORTABLE SPOT WELDING GUN

YUHSIN



- 適用於排油煙機、流理台、廚房器具、OA辦公傢具之專業生產工廠

Application: Smoke exhaust electric stove, Kitchen sink, kitchen cabinet, kitchen utensil & OA office furniture

台灣製造
Made in Taiwan

型式 Type	定 格 容 量 Nominal Capacity	一 次 入 力 Primary Voltage	最大溶接電流 Max. Weld Current	容許使用率 Duty Cycle	尺寸 Dimension WxDxH	重 量 Weight
	KVA	V	A	%	mm	Kg
YS-PA063	6	220	5500	10	350 x 360 x 200	16

焊臂

ARMS

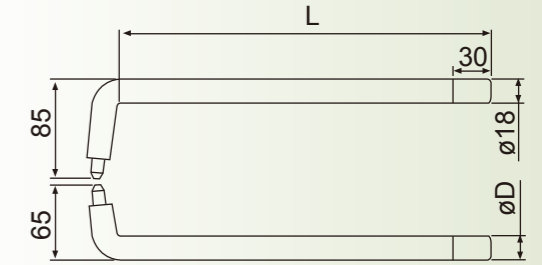
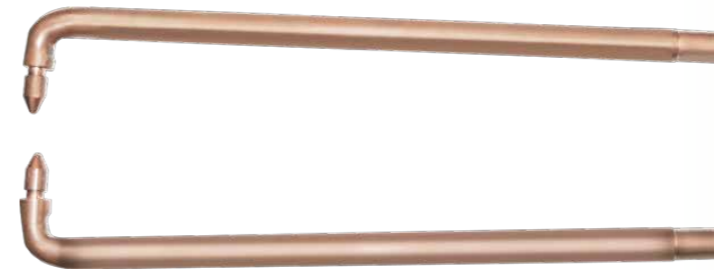

材質：CC合金銅

型式 Type	CD19200	CD19250	CD19300
øD	19	19	19
L	200	250	300

註：如有特殊規格，歡迎訂製。
Custom requirement is welcome.

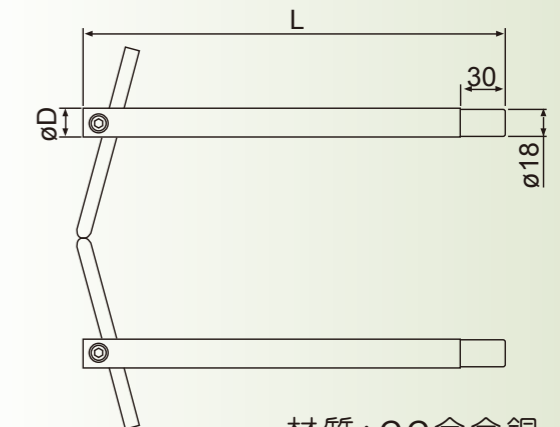
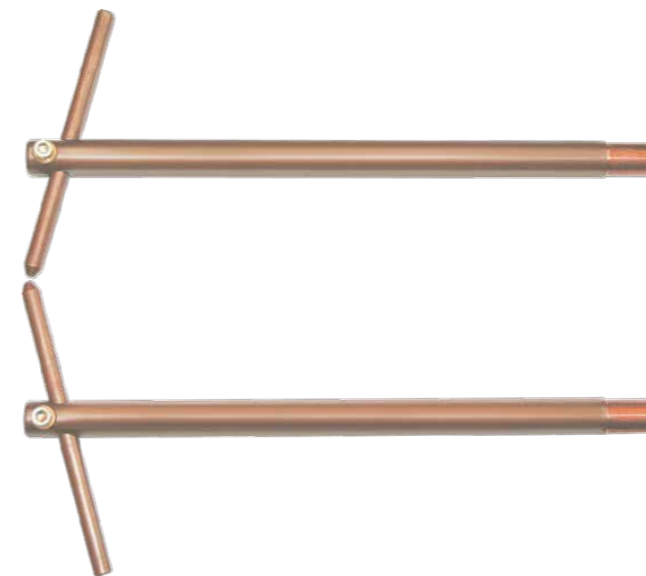

材質：CC合金銅

型式 Type	CD19247	CD19330
øD	19	19
L	247	330

註：如有特殊規格，歡迎訂製。
Custom requirement is welcome.

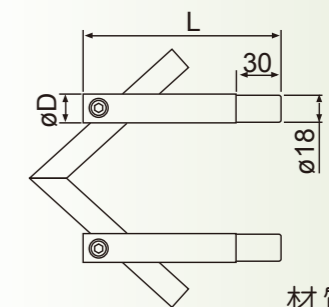
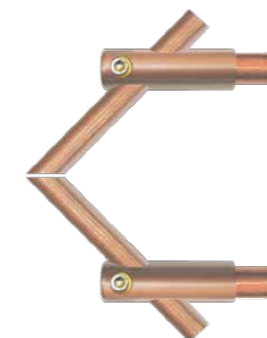

材質：CC合金銅

型式 Type	CD19110	CD25110
øD	19	25
L	110	110

註：如有特殊規格，歡迎訂製。
Custom requirement is welcome.

電容型足踏、空壓式點焊熔接機

DESK TYPE OF FOOT-PEDAL-PNEUMATIC CAPACITOR DISCHARGE SPOT WELDING MACHINE

YUHSIN



YS-UA5
(YSCP005 + YSEAASEF500 + YSDW3100034 + YEA9004271)

電容型足踏式點焊熔接機 (桌上型工作台)
Desk Type Foot-pedal Capacitor Discharge
Spot Welding Machine
500VA

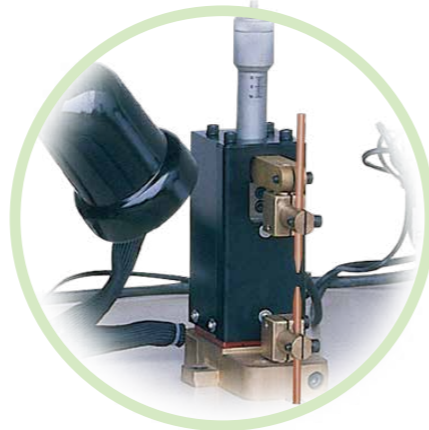

YS-UB5
(YSCP005 + YSEAASET500 + YSDW3100034 + YEA900427)

電容型空壓式點焊熔接機 (桌上型工作台)
Desk Type Pneumatic Capacitor Discharge
Spot Welding Machine
500VA

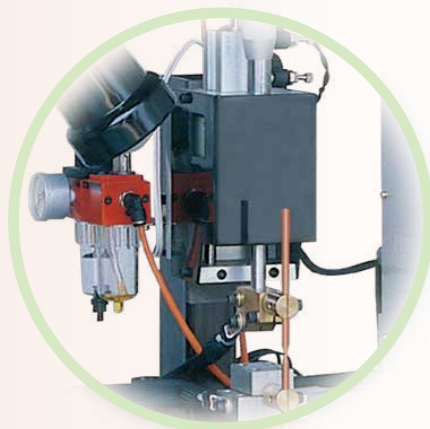

電容型空壓式點焊熔接機

DESK TYPE OF PNEUMATIC CAPACITOR DISCHARGE SPOT WELDING MACHINE

YS-UB10
(YSCP010 + YSEAASET1000 + YSEAA9706204)
電容型空壓式點焊熔接機 (桌上型工作台)
Desk Type Pneumatic Capacitor Discharge
Spot Welding Machine
1000VA



YS-UC5
(YSCP005 + YSEAASEK500 + YSDW3100034 + YEA900427)

電容型空壓式雙頭單面點焊熔接機 (桌上型工作台)
Desk Type Pneumatic Capacitor Discharge Twin-Head
Single-side Spot Welding Machine
500VA

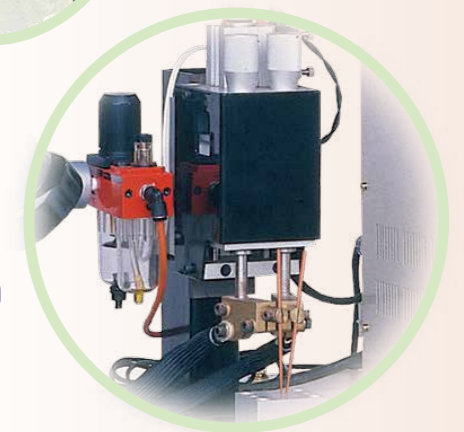
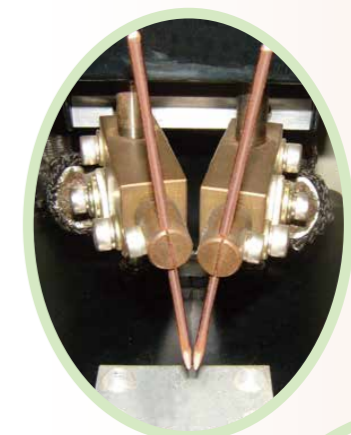

電容型空壓式點焊熔接機

DESK TYPE OF PNEUMATIC CAPACITOR DISCHARGE SPOT WELDING MACHINE

交流空壓式點焊熔接機

PNEUMATIC AC TYPE SPOT WELDING MACHINE

YUHSIN



YS-UF
5KVA-8KVA
電容型空壓式點焊熔接機
Capacitor Discharge Spot
Welding Machine



YS-UF
10KVA-15KVA
電容型空壓式點焊熔接機
Capacitor Discharge Spot
Welding Machine



YS-AC55-05
(YSPW3100055 + YSEASET500 + YSEA900427)
交流型空壓式點焊熔接機(桌上型工作台)
AC Desk Type Pneumatic Spot Welding Machine
5.5 KVA



YS-UB350
35KVA交流型空壓式點焊熔接機(桌上型工作台)
AC Desk Type Pneumatic
Spot Welding Machine

電容式溶接機規格 Capacitor Discharge type welding machine specifications

型式 Type	電源 Power	容量 Capacity	電極加壓方式 The method of electrode pressurization	喉深 Throat depth (mm)	喉間隔 Throat gap (mm)	最大加壓力 Max. Pressure Force	溶接能力 Dissolve ability (mm)		
							合金 Alloy	黃銅 Brass	鐵 Metal
YS-UF30	單相 Single 220V 50/60HZ	3	空壓式 Pneumatic	400	50~80	50~600	1.2	1.2	1.2
YS-UF50	單相 Single 220V 50/60HZ	5	空壓式 Pneumatic	400	150~300	80~1000	1.6	1.6	1.6
YS-UF80	單相 Single 220V 50/60HZ	8	空壓式 Pneumatic	400	150~300	80~1000	2.0	2.0	2.0
YS-UF100	單相 Single 220V 50/60HZ	10	空壓式 Pneumatic	400	150~300	120~1600	2.0	2.0	2.6
YS-UF150	單相 Single 220V 440	15	空壓式 Pneumatic	400	150~300	120~1600	2.3	2.3	3.0
YS-UF200	單相 Single 220V 440	20	空壓式 Pneumatic	400	150~	120~1600	3.0	3.0	3.5

變頻空壓式點焊熔接機

PNEUMATIC INVERTER DC SPOT WELDING MACHINE

變頻空壓式直流點焊熔接機

PNEUMATIC INVERTER DC SPOT WELDING MACHINE

NIHSHIN



日本テトラック台湾代理商

YS-HF80
(TH-50VFS + YSEAASEK500 + YSDWH2-2500B + YSEA900427)
變頻型空壓式點焊熔接機 (桌上型工作台)
Desk Type Pneumatic Inverter DC Spot Welding Machine

- 實現寬闊範圍的熔接電流，最可靠的高品質焊接。
 - 有效控制凹口，燒痕和波動焊接電流所產生的變形。
 - 消除三相電源上的不安定和低輸出功率。
 - 在銅合金和鋁合金的焊接過程中顯現高品質熔接效果。
- Realization of the most reliable high-quality welding due to a wide range of welding current.
 - Maximum control of indentation, burning and distortion by nonfluctuating welding current.
 - Elimination of uneasiness on power supply by 3-phase balance load and low output KVA.
 - Performance shown in welding of copper alloy and aluminum alloy.



YS-HF504
變頻型空壓式直流點焊熔接機
Pneumatic Inverter DC Spot
Welding Machine
50KVA

空冷電纜線 Air Cooled Cable

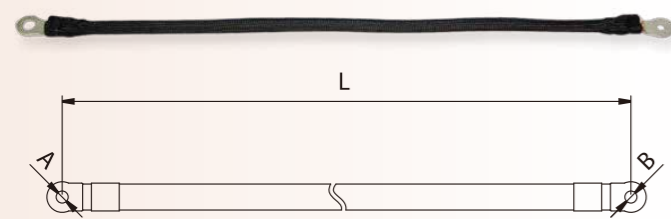

線徑	長度(L)	端子孔徑(φA)	端子孔徑(φB)
38平方	mm	mm	mm
60平方	mm	mm	mm
80平方	mm	mm	mm
100平方	mm	mm	mm

變頻式直流點焊熔接機規格 Inverter DC spot welding machine specification

形式 Type	規格 Specification	定格容量 Nominal Capacity	入力電壓 Input Voltage	週波數 Frequency	最大短路電流 Max. Short Current	最大入力 Max. Weld Power	容許使用率 Duty Cycle	最大加壓力 Max. Pressure Force	喉間尺寸 Throat Size	冷卻水量 Cooling water supply
		KVA	V	HZ	A	KVA	%	kg	mm	ℓ /min
YS-HF504		50	220/440	50/60	20,000	110	10	500	200x400	15
YS-HF1004		100	220/440	50/60	30,000	220	10	1000	200x400	15
YS-HF1504		150	440	50/60	42,000	330	10	1500	200x400	15

點焊熔接機

WELDING MACHINE

YUHSIN

特殊機型 Special Models



YS-CL80

80KVAx2龍門型點焊熔接機
Double-Column Spot
Welding Machine

本機械適用於鐵柵板之焊接
Gantry Welders Is Ideally Used in
Lattice Plank Production



YS-C354-2

35KVA雙機頭點焊熔接機
Twin-head single-side spot
welding machine

點焊熔接機

SPOT WELDING MACHINE

空壓式標準機型 Pneumatic Standard Models

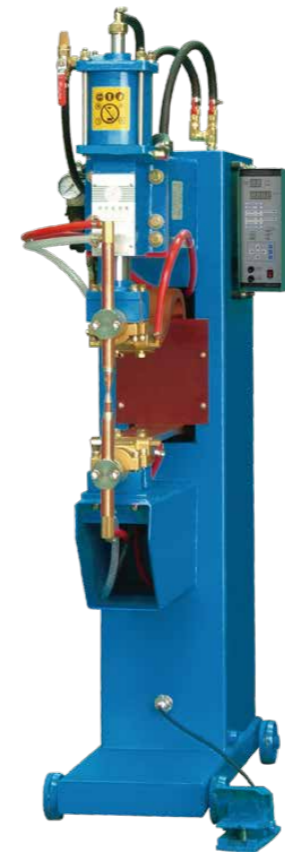

YS-C504
35~50KVA

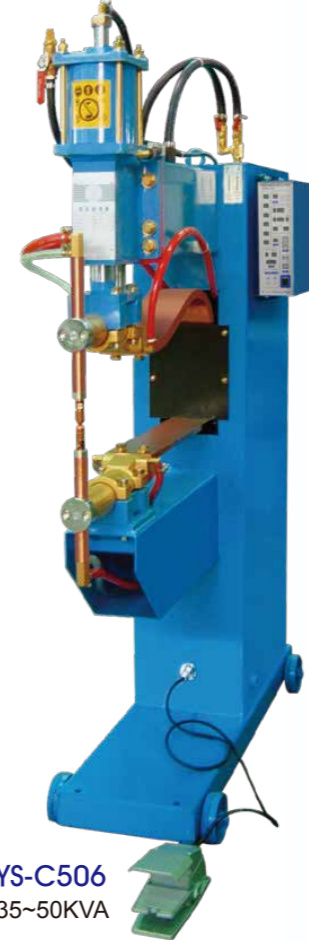

YS-C506
35~50KVA



YS-CP1004
75~100KVA

標準機型規格表 Specifications

形式 Type	規格 Specificaon	定額容量	一次電壓	週波數	最大電流(溶接時)	最大入力(溶接時)	容許使用率	喉部尺寸	電極棒(座)	電極頭	最大 加壓力	冷卻水量	重量
		Nominal Capacity	Input Voltage	Frequency	Max. Welding Current	Max. Welding Input	Duty Cycle	Throat Size GapxDepth	Electrode Bar(Seat)	Electrode Tip	Max. Pressure Force	Cooling Water	Weight
		KVA	V	HZ	A	KVA	%	深x間隔 mm	mmø	mmø	kg	ℓ /min	kg
單 點 式 熔 接 機 Spot welders	YS-C354	35	220	50/60	15,000	79/87	9.9/8.1	200*400	25	16	500	6	275
	YS-C356	35	220	50/60	14,000	77/86	10.3/8.4	200*600	25	16	500	6	280
	YS-C504	50	220	50/60	18,000	99/110	12.8/10.3	200*400	25	16	500	6	295
	YS-C506	50	220	50/60	16,000	88/98	16.1/13.1	200*600	25	16	500	6	300
	YS-C508	50	220	50/60	14,000	81/91	19.0/15.2	200*800	25	16	500	6	310
	YS-C754	75	220	50/60	22,500	123/143	12.0/8.8	200*400	25	19	1000	8	460
新 用 式 雙 機 頭 點 焊 熔 接 機 Spot and projection welders	YS-CP354	35	220	50/60	18,000	94/104	6.9/5.6	180*400	25	16	500	6	283
	YS-CP504	50	220	50/60	23,000	133/149	7.0/5.6	180*400	25	16	500	8	305
	YS-CP754	75	220	50/60	29,000	220/254	6.6/5.0	180*400	32	19	1000	8	470
	YS-CP1004	100	220	50/60	32,000	296/350	5.7/4.1	180*400	32	19	1000	8	490
浮 心 專 用 點 焊 熔 接 機 Projection welders	YS-CA503	50	220	50/60	28,000	181/205	3.8/3.0	200*300			1000	8	305
	YS-CA753	75	220	50/60	33,000	296/350	3.6/2.6	200*300			1000	8	470
	YS-CA1003	100	220	50/60	35,000	296/350	5.7/4.1	200*300			1500	8	490
	YS-CA1503	150	220	50/60	43,000	411/450	6.6/5.5	200*300			1500	10	600
YS-CA2003	200	440	50/60	50,000	550/611	6.6/5.4	200*300			3000	10	650	

點焊熔接機

SPOT WELDING MACHINE

NIHSHIN

足踏式標準機型 Foot Pedal Models

YS-FS30
30KVA
標準型Standard Type

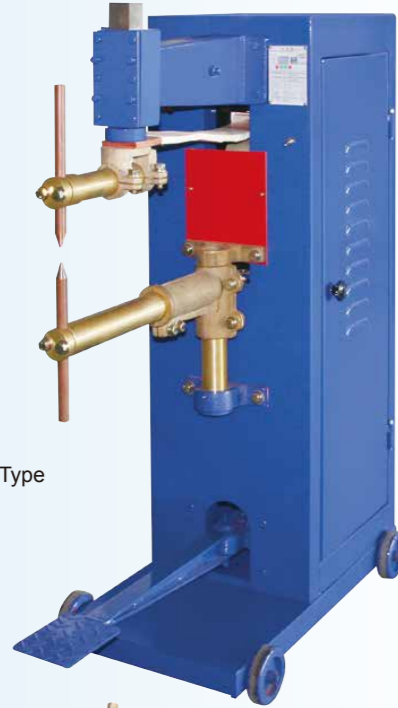

YS-FC30
30KVA
單點型Single Spot Type



YS-FB30
30KVA
鳥型Bird Type



YS-FB30-2
30KVA
高砲型High Cannon Type



點焊熔接機

SPOT WELDING MACHINE

特殊機型 Special Models

YS-CS506
35~75KVA

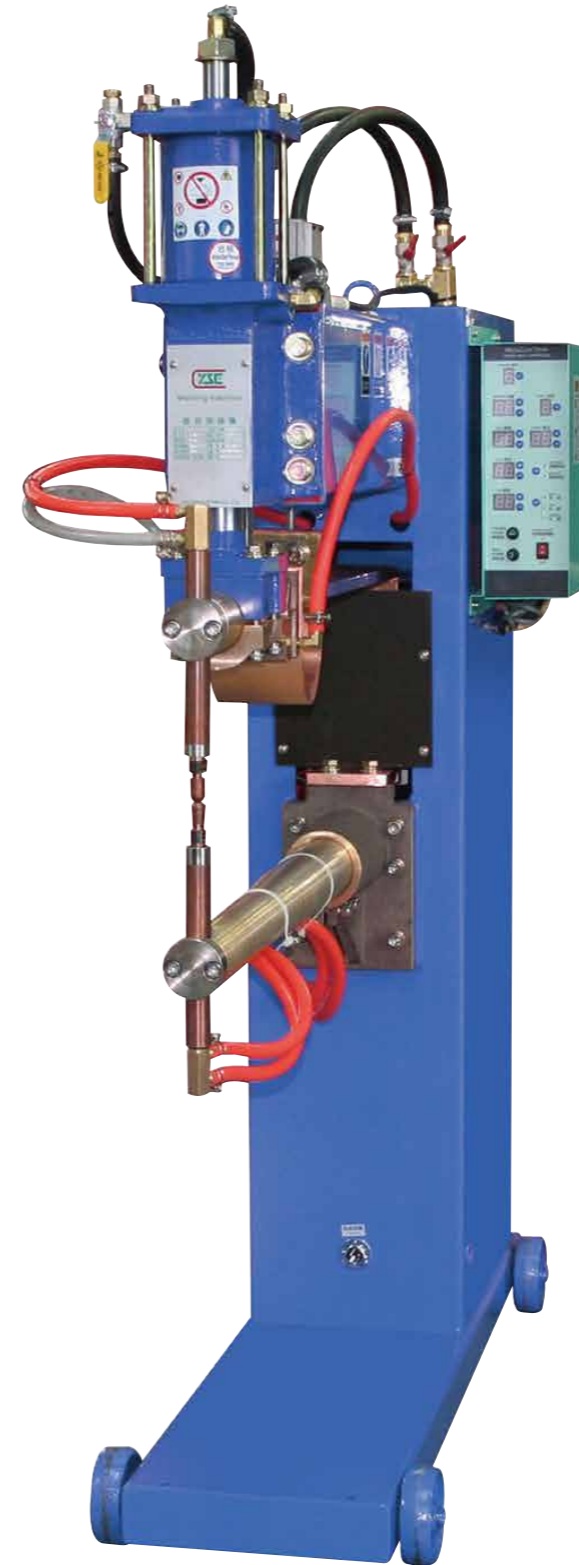

YS-CS354
35KVA
後照鏡支架專用



點焊熔接機

SPOT WELDING MACHINE

三相空壓式直流點焊熔接機 / 交流雙頭輪焊機

THREE-PHASE PNEUMATIC WELDING MACHINE / AC TWIN-HEAD TYPE SEAM WELDERS

YUHSIN

特殊機型 Special Models

板金、開關箱專用
For Slab Metal、Switch Box

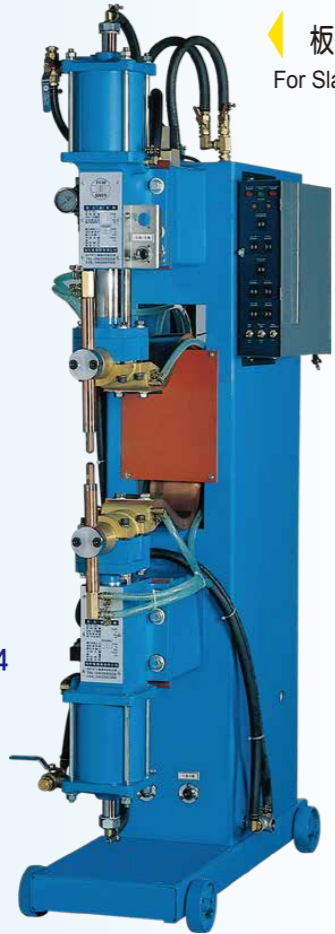

YS-SA504
50KVA



YS-SE504
50KVA



雙頭單面點焊熔接機
Twin-Head Single-side Spot
Welding Machine

YS-CS506
50KVA

鐵窗用
For Steel Window

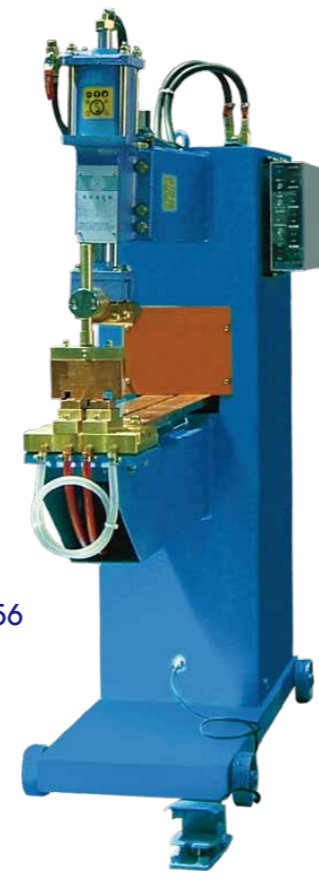

YS-SD756
75KVA



YS-DC2004
三相空壓式直流點焊熔接機
Three Phase Pneumatic
DC Welding Machines
200KVA

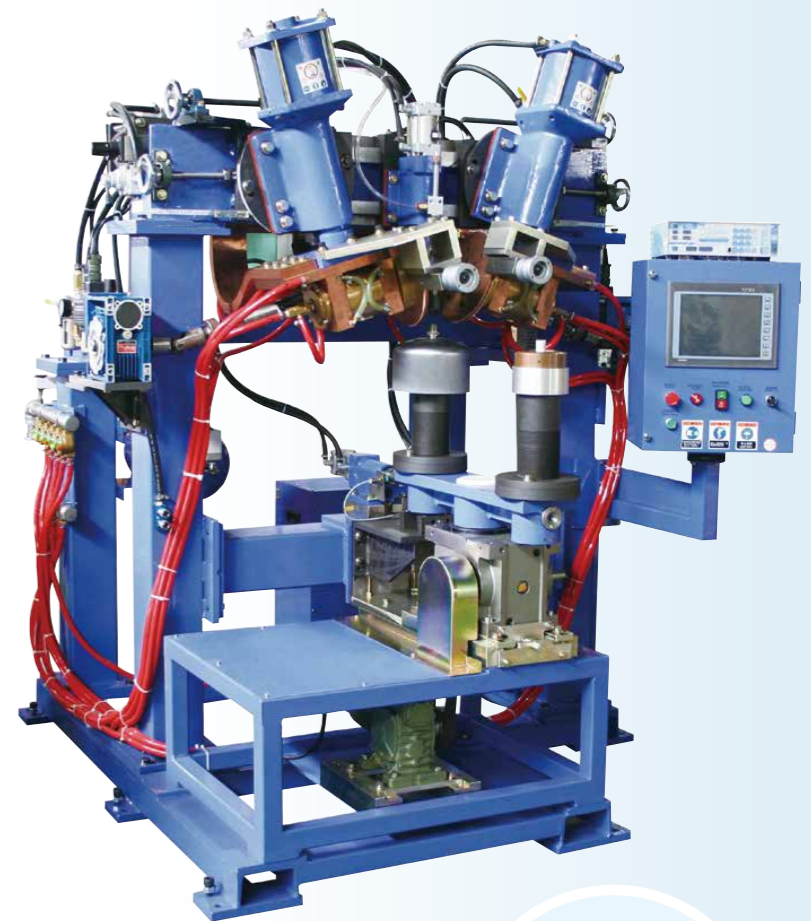

YS-CW250
250KVA雙頭輪焊機
Twin-Head Type Seam Welders

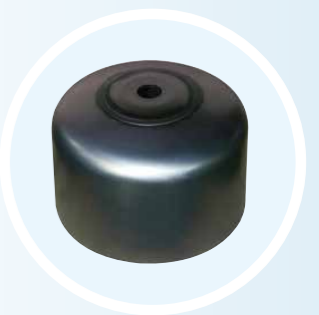

■ 本機械適用於高壓桶之焊接
Seam Welders Used For
High-pressure Bucket

單相、三相直流點焊熔接機規格 Single, Three-phase DC Welding Machine Specifications

形式 Type	規格 Specifaicon	定容量 Nominal Capacity	一次電壓 Primary Voltage	週波數 Frequency	最大短路電流 Maximum short-circuit current	最大入力(溶接時) Maximum Input (during welding)	容許使用率 Duty Cycle	喉部尺寸 Throat Dimensions Gap x Depth	最大加壓力 Max. Pressure Force	電極行程 二段式 Two-Step Stroke	冷卻水量 Cooling water supply
		KVA	øV	HZ	A	KVA	%	間隔x深	kg	mm	ℓ /min
單相 Single-phase Input	YS-DC354	35	1ø220	50/60	21,000	90	7.5	200x400	500	30.80	20
	YS-DC504	50	1ø220	50/60	29,000	151	4.5	200x400	500	30.80	20
	YS-DC754	75	1ø220	50/60	37,000	210	5.0	200x400	1000	100	20
三相 Three-phase Input	YS-DC1004	100	3ø220	50/60	35,000	305	5.0	300x400	1500	80	30
	YS-DC1504	150	3ø220	50/60	48,000	460	5.0	300x400	1500	100	30
	YS-DC2004	200	3ø220	50/60	65,000	610	5.0	300x400	3000	100	30

單相閃焊熔接機

SINGLE PHASE FLASHING BUTT WELDER

YUHSIN



YS-CB01500201
150KVA

■ 本機械適用於
鐵管 Iron pipe: ϕ 15m/m-30m/m
圓鐵 Circle iron: ϕ 6m/m-15m/m



YS-CB0200201
150KVA

■ 本機械適用於
白鐵板 Stainless steel : 3mm

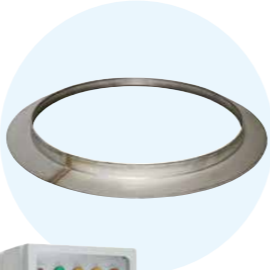

碰焊熔接機

BUTT WELDING MACHINE



YS-CB100
100KVA H型碰焊熔接機 (2組)
Butt Welding Machine,
For H shape welds
使用範圍 Application: ϕ 1.2~ ϕ 2.5

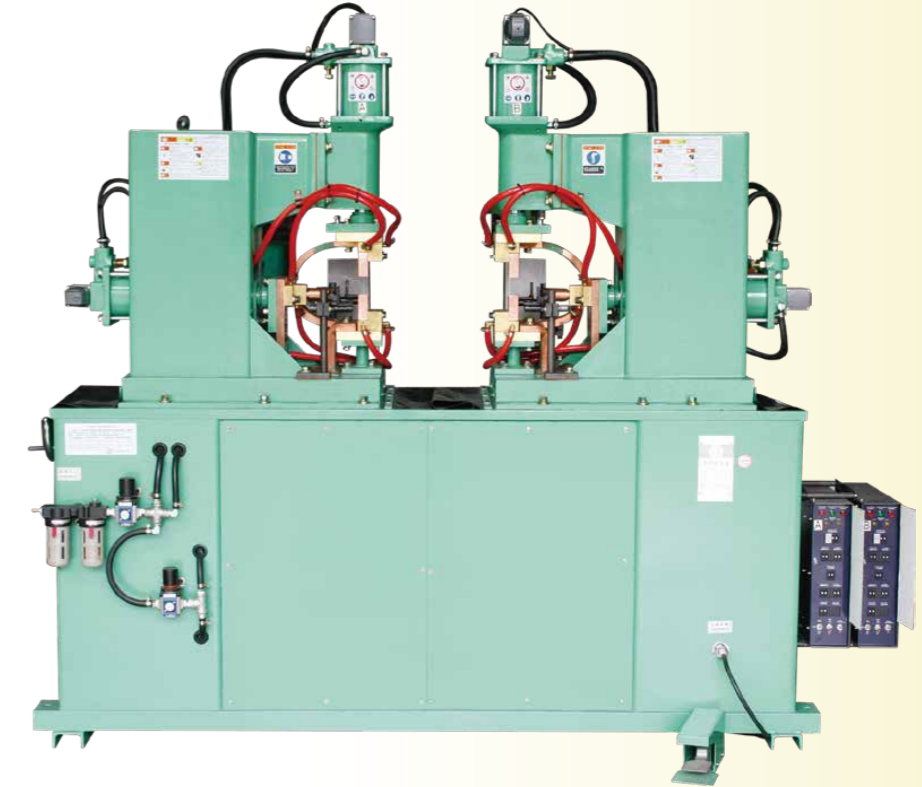

三相直流式閃焊熔接機

THREE PHASE DC FLASHING WELDERS

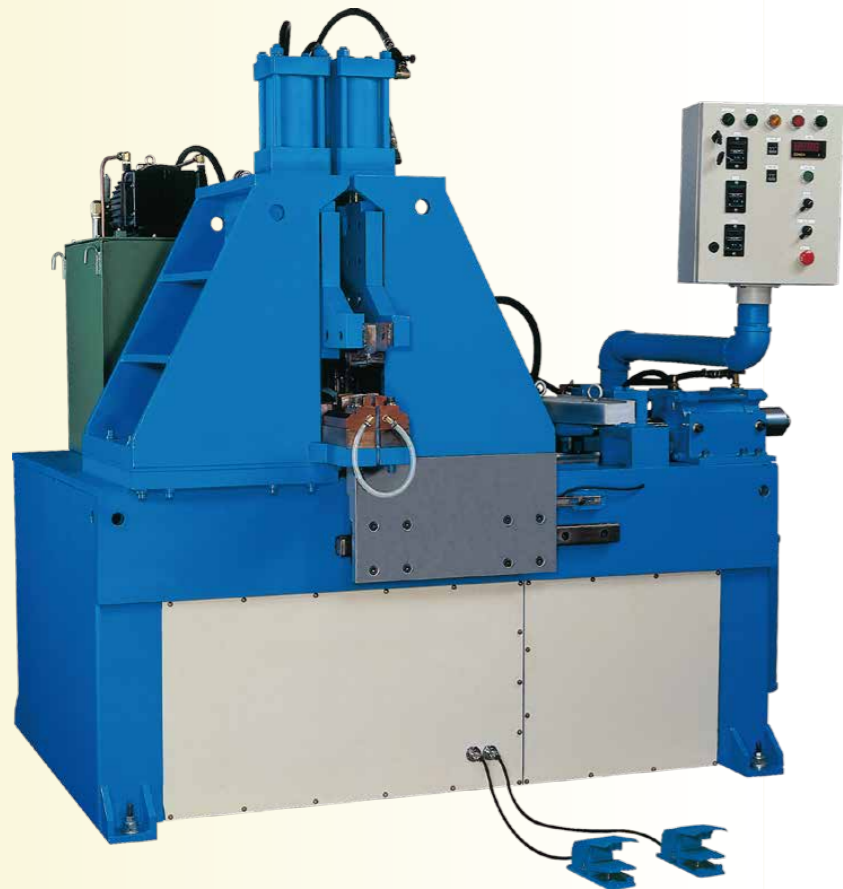

■ 本機械適用於 Application :
機車、腳踏車、鋼圈、鋁圈之焊接
Bicycle, Motorcycle, steel,
Aluminum RIM

YS-DF300
300KVA-1000KVA

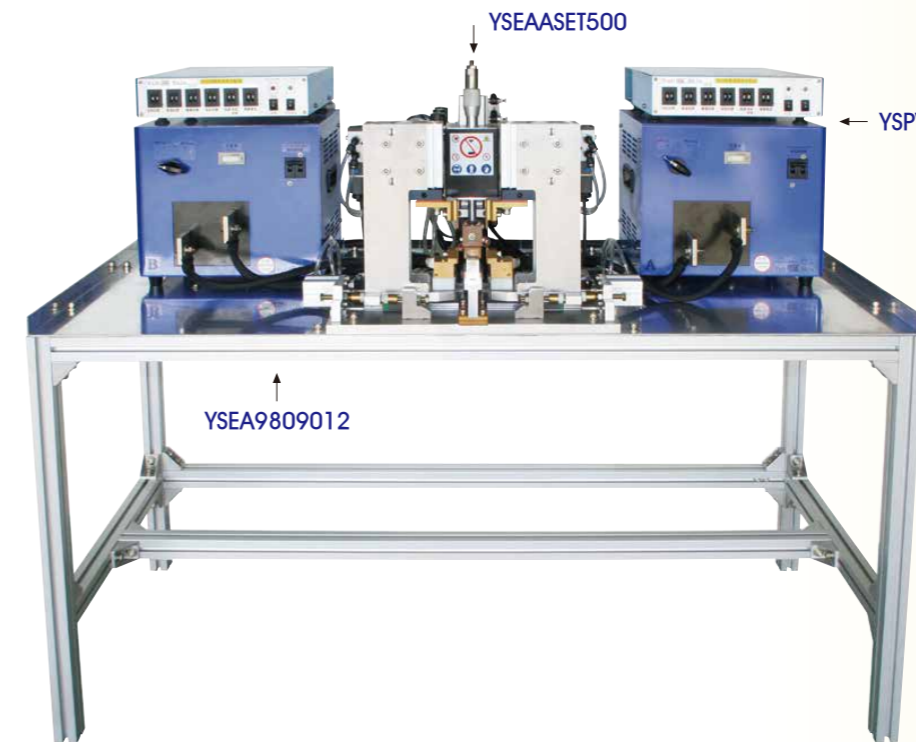

YSEAASET500
YSPW3100055
YSEA9809012

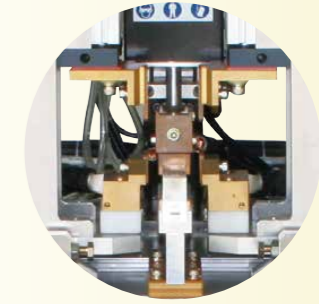

YS-CB00055201
(YSPW3100055 + YSEAASET500
+ YSEA9809012)
5.5KVA空壓式碰焊機-雙機頭
Pneumatic Butt Welding Machine-
Twin-Head

碰焊熔接機

BUTT WELDING MACHINE

YUH SHIN

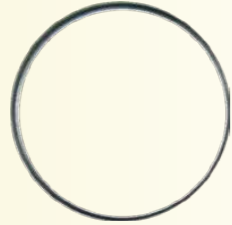

■ 本機械適用於碳鋼圈之焊接
Butt Welders Used for
Carbon-steel Wheel

YS-CB35

35KVA-85KVA碰焊熔接機
Pneumatic Butt welding Machine

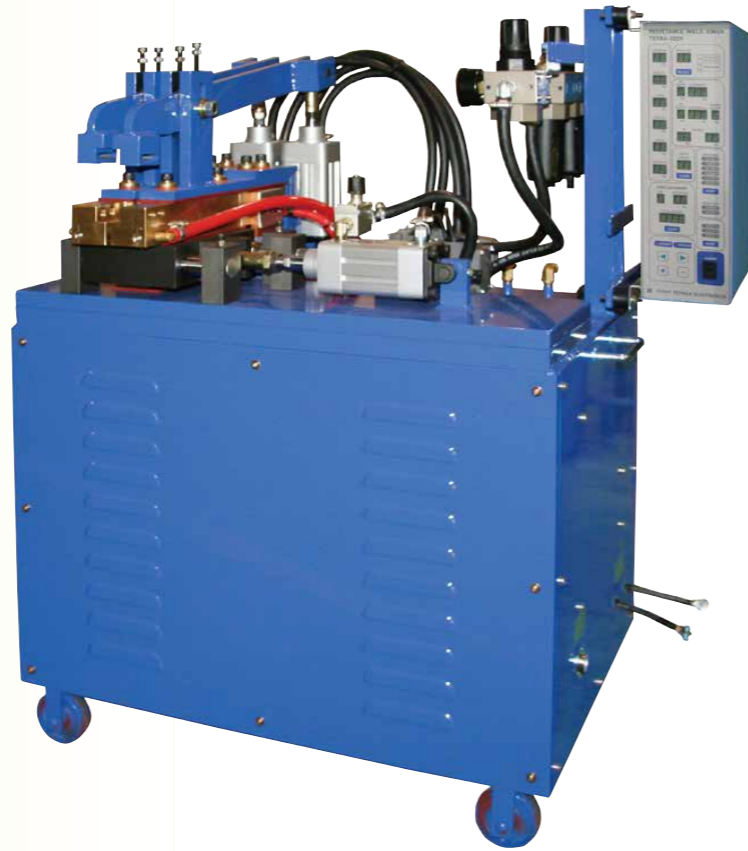

YS-CB50

50KVA-100KVA碰焊熔接機
Butt Welding Machine

碰焊熔接機

BUTT WELDING MACHINE

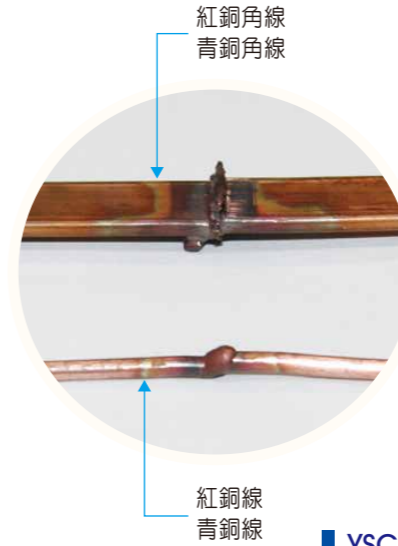

紅銅線
青銅線

YSCB10

15KVA 碰焊熔接機
Butt Welding Machine



YSCB30

30KVA 碰焊熔接機
Butt Welding Machine