

# 專利 PATENT



## 索引 INDEX

### 桌上型倒角機

JT-500AG	萬能平面銑刀倒角機	Omnipotent Face Mill Chamfering Machine	2
JT-500A	側銑刀式倒角機	Side Mill Chamfering Machine	3
JT-500AQ	側銑刀式C&R角雙用機	C&R Dual Angle Chamfering Machine	4
JT-500DF	多功能型倒角機	Multi-Function Chamfering Machine	5
JT-500B.500BR	砂輪式、平面銑刀倒角機	Wheel type. Face Mill Chamfering Machine	6
JT-300A	規則+不規則式倒角機	Inverter Chamfering Machine	7
JT-320B	砂布輪式倒角機	Disk Esper Chamfering Machine	8

### 手提式倒角機

JT-R6	手提倒角機	Portable Chamfering Machine	8
JT-40A	手提倒角雕刻機	Portable Chamfering Engraving Machine	9
JT-C3.R3	手提規則、不規則式倒角機	Portable Regular. Irregular Chamfering Machine	10
JT-100C.100R	手提規則、不規則式倒角機	Portable Regular. Irregular Chamfering Machine	11
JT-200A	手提式倒角機1HP	Portable Chamfering Machine	12
JT-250GS	手提式倒角機2HP	Portable Chamfering Machine	13

### 自走式倒角機

JT-12C	自走式倒角機	Self-Propelled Chamfering Machine	14
JT-18C	自走式倒角機	Self-Propelled Chamfering Machine	14

# JT-500AG 萬能平面銑刀倒角機 Omnipotent Face Mill Chamfering Machine

**NEW**

CE

**專利品 PATENT**



標準品  
Accessory

MODEL	JT-500AG
Machine Size	L500xW430xH300mm
Voltage	3Ø, 220V-440V, or 1Ø, 110V/220V; 50Hz/60Hz
Motor	1HP, 3500 r.p.m.
Height of bevel	0~4mm, 45°
N.W. / G.W.	48.5kgs / 58kgs
Packing	50x60x40cm, 4.4 Cuft
Track Size	500x150x20mm, 500x92x12mm



選購品: 滑台式 (切削時較不會傷及工件表面)  
Optional: Flat Track Table (To avoid the surface crashed)

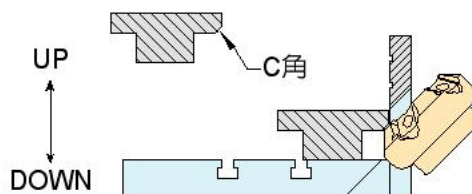

T型工件倒角  
T type workpiece chamfering



倒角樣品  
Chamfering sample



標準配備 Accessory  
平面銑刀



選購 Optional  
鑽石砂輪



選購 Optional  
砂布輪4"

**特點 Features :**

- A. 可利用T型槽治具不傷及表面之倒角及利用軌道上下作T字型工件之倒角。
- A. The T-slot table can option with T jig to avoid the surface crashed. Also, to move up and down for chamfering the T workpiece by track.

訂購編號	品名	規格
02-2BB-91	鑽石砂輪 Diamond Wheel	Ø60xØ17
02-2DB-811	砂布輪 Disk Esper Emery Wheel	Ø100xØ16
02-2BB-94	平面銑刀頭組 Face Mill Cutter	Ø45xØ17x35mm
02-2BE-042	刀片 Blade	SEKN 1203x5pcs
02-2BE-02	壓片 Plate	
02-2BE-03	螺絲 Bolt	

# JT-500A 側銑刀式倒角機 Side Mill Chamfering Machine



**簡易型**



MODEL	JT-500A
Machine Size	L500xW350xH320mm
Voltage	3Ø, 220V-440V, or 1Ø, 110V/220V; 50Hz/60Hz
Motor	1HP, 3500 r.p.m.
Height of bevel	0-3mm, 15°~45°
N.W. / G.W.	26kgs / 29kgs
Packing	55x42x32cm, 2.74 Cuft
Track Size	500x100x12mm, 500x40x12mm

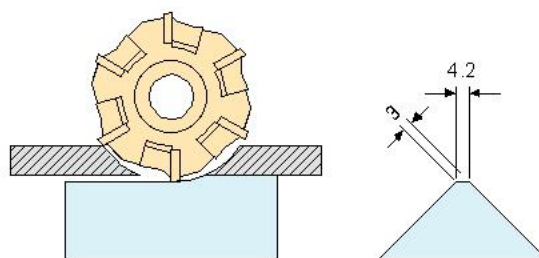

倒角圖示

### 特點 Features :

- A. 適用於各種鋼、鐵、鑄鐵及非金屬材質。
- B. 軌道座可調整角度、倒角後工件可成15度~45度的不同需求。

- A. A available for chamfering steel, iron, casting iron and non-metal materials.
- B. Swivel table for chamfering workpeice with different angle during 15~45 degree.



標準配備  
Accessory

訂購編號	品名	規格
02-2AB-90	側銑刀頭組 Side Mill Cutter	Ø63xØ17x15mm
02-2AB-912	刀片 Blade	SPUN1203x6pcs
02-2AB-92	壓片 Plate	
02-2AB-93	螺絲 Bolt	

### 500A & 500AQ 比較表

項目 型號	配備的切削刀具	倒角能力	倒C角時 角度調整	移動軌道座 調整刀片的切削點	倒角後狀態	購買機器成本	長期使用消耗 刀片成本
500A	側銑刀C角單用	0~3C	可旋轉15~45度 做角度變化 <b>勝</b>	無	C角兩側仍為 銳角	簡單型 成本較低 <b>勝</b>	成本高
500AQ	可加購R角側銑刀 即C+R角兩用 <b>勝</b>	0~3C 2R~5R <b>勝</b>	固定45度無法變化	可前後微調讓刀片 完全的利用 <b>勝</b>	R角圓弧狀 不傷人 <b>勝</b>	完美型 成本略高	刀片完全 利用節省 一半成本 <b>勝</b>

### 500A & 500AQ COMPARISON

ITEM MODEL	Cutting Tools	Chamfering Capacity	Angle adjusting for chamfering C	Swivel track table, adjustable cutting point of side cutter	The state after the angle	Costs for purchase	Consuming cost of tools ( For long-term)
500A (Original)	Side cutter only for chamfering C angle	0~3C	15°~45° degree angle swivel <b>WIN</b>	No functions	Both side of C angle with shaply angle	Simple model / Lower costs <b>WIN</b>	High cost
500AQ (New model)	Optional R angle side cutter for C+ R dual angle <b>WIN</b>	0~3C (Optional) 2R~5R <b>WIN</b>	Fixed, 45° degree angle only	Table can do slight adjusting front and back to make the side mill cutter full be used <b>WIN</b>	The R angle with circle -radian and safety <b>WIN</b>	Advance model / Higher costs <b>WIN</b>	Saving half costs <b>WIN</b>

# JT-500AQ 側銑刀式C&R角雙用機 C&R Dual Angle Chamfering Machine(Side Mill Type)

**NEW**

CE

雙專利品 DOUBLE PATENT

**專業型**



MODEL	JT-500AQ
Machine Size	L500xW400xH320mm
Voltage	3Ø, 220V-440V, or 1Ø, 110V/220V; 50Hz/60Hz
Motor	1HP, 3500 r.p.m. (Standard)
Motor	1HP, 0~12000 r.p.m. (Optional)
Height of bevel	0~3mm/45°, 2R, 3R, 5R
N.W. / G.W.	28kgs / 31kgs
Packing	55x46x32cm, 3 Cuft
Track Size	500x100x12mm, 500x40x12mm

## 特點 Features :

- A. 使用側銑刀捨棄式刀片之C&R角均可倒角,更換迅速。
  - B. 本機構可調整該C角之切削點,使刀片之邊側,完全利用。
  - C. 為使倒角後表面更加美觀,可加變頻器使速度由3500r.p.m.至12000r.p.m.以內供其選擇。
  - D. R角側銑刀頭及R2, R3, R5之刀片均為選購附件。
- A. Easy chamfering any length of steel, iron, casting iron and non-metal materials.
  - B. Adjustable cutting point of C angle to make the full using of side knife.
  - C. Optional Inverter (3500 ~ 12000r.p.m.) In order to make the surface of workpeice smoothly after chamfered.
  - D. Optional accessories : R side mill cutter. The knife specification from R2, R3, R5.

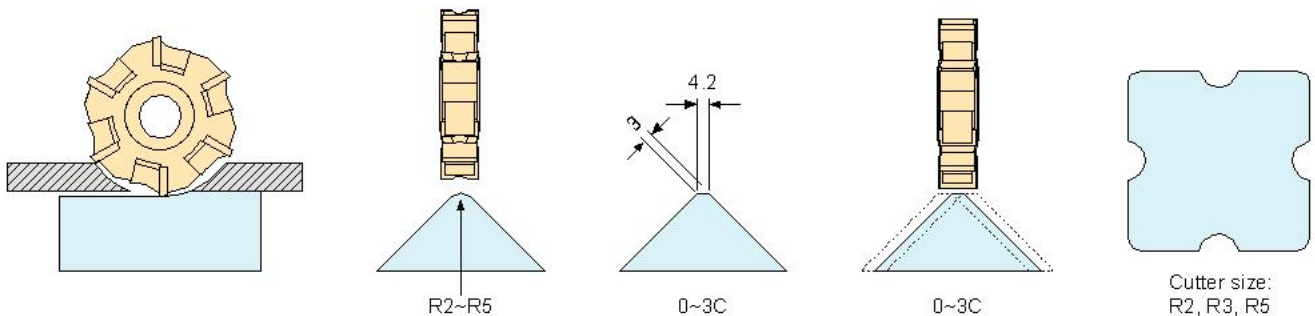

標準配備  
Accessory



選購  
Optional

訂購編號	品名	規格
02-2AB-90	側銑刀頭組 Side Mill Cutter	Ø63xØ17x15mm
02-2AB-912	刀片 Blade	SPUN1203x6pcs
02-2AB-92	壓片 Plate	
02-2AB-93	螺絲 Bolt	
02-2AB-901	R刀頭組 Side Mill Cutter	
02-2AB-915	2R刀片 2R Blade	
02-2AB-913	3R刀片 3R Blade	
02-2AB-914	5R刀片 5R Blade	

# JT-500DF 多功能型倒角機 Multi-Function Chamfering Machine



MODEL	JT-500DF
Machine Size	L500x W420xH350mm
Voltage	3Ø, 220V-440V, 1Ø 110V/220V; 50Hz/60Hz
Motor	1HP, 3500 r.p.m.
Height of bevel	0~3mm, 45°
N.W. / G.W.	32kgs / 36kgs
Packing	55x44x38cm, 3.4 Cuft
Track Size	500x100x12mm, 500x40x12mm

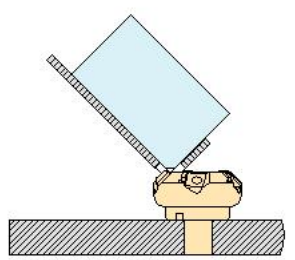

(特點A)

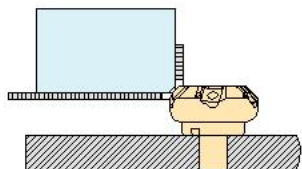

(特點B)



標準配備  
Accessory

### 特點 Features :

- A. 採用盆型砂輪及平面銑刀可替換使用，V型軌道座可使切削更省力。
- B. 使用平面銑刀切削，刀刃遲鈍時可再利用軌道座的旋轉角度，使刀片再再利用，大大的提高了刀片的價值，**等於節省了一半的刀片價格。**
- A. Adopt with bowl type wheel and face mill cutting. Both are exchangeable. The V type table is easy for chamfering and saving energy.
- B. In the face mill cutting function. You can adjust the swivel angle to make the insert cutter to be valued using and saving the consumption costs of tools.

訂購編號	品名	規格
02-2BB-91	砂輪 Bowl Wheel	Ø100xØ17x50mm
02-2BB-94	平面銑刀組 Cutter	Ø40xØ17x35mm
02-2BE-042	刀片 Blade	SEKN1203x5pcs
02-2BE-02	壓片 Plate	
02-2BE-03	螺絲 Bolt	

### 500BR & 500DF 比較表

項目 型號	配備的切削刀具	軌道座功能差異	防屑與刀具護蓋 +除屑設計	調整切削量 使用工具	購買機器成本	長期使用消耗 刀片成本
500BR	平面銑刀=單用	固定無法變化	無	開口+六角兩種板手	簡單型 成本較低 <b>勝</b>	成本高
500DF	平面銑刀+砂輪 =兩用 <b>勝</b>	V型+L型 互補節省 一半刀片的成本 <b>勝</b>	三者皆具 <b>勝</b>	不需任何工具 即可調整 <b>勝</b>	完美型 成本略高	比舊型節省 一半成本 <b>勝</b>

# JT-500C(500B+500BR) 雙用機(砂輪+平面銑刀式)

Functions Chamfering Machine ( Face Mill & Wheel Mill Cutting )



MODEL	JT-500BR
Machine Size	L500xW420xH350mm
Voltage	3Ø, 220V-440V, or 1Ø, 110V-220V; 50Hz/60Hz
Motor	1HP, 3500 r.p.m.
Height of bevel	0~3mm, 45°
N.W. / G.W.	28kgs / 31kgs
Packing	55x44x38cm, 3.4 Cuft
Track Size	500x100x12mm, 500x40x12mm

## JT-500B 砂輪式倒角機 Wheel Type Chamfering Machine

### 特點 Features :

- A. 採用盆型砂輪切削，針對熱處理或特殊處理的工件做倒角。
- B. 如用於一般鐵材會起毛邊。
- A. Adopt with bowl type wheel mill cutting. Special for chamfering the workpiece of heat treatment or particular process.
- B. It may be caused rough surface, if processing for general iron materials.

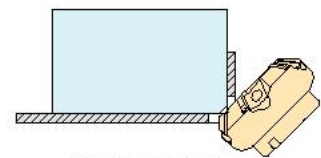

倒角圖示



標準配備  
Accessory

訂購編號	品名	規格
02-2BB-91	砂輪 Bowl Wheel	Ø100xØ17x50mm
02-2BB-80	鎖砂輪墊片	Ø40xØ17x5
02-2BB-81	鎖砂輪墊片	Ø40xØ10x5

## JT-500BR 平面銑刀式倒角機 Face Mill Chamfering Machine

### 特點 Features :

- A. 採用平面銑刀原理，倒角較省力而且加工後的表面較側銑刀的加工面更為光滑美觀。
- B. 適用於各種材質(不含熱處理材質)。
- A. Adopt with face mill type cutting, easy to operate and save energy for chamfering process.
- B. The surface is more finished and more smoothly than side mill cutting after chamfered.



標準配備  
Accessory

訂購編號	品名	規格
02-2BB-94	刀頭 Cutter	Ø40xØ17x35mm
02-2BE-042	刀片 Blade	SEKN 1203x5pcs
02-2BE-02	壓片 Plate	
02-2BE-03	螺絲 Bolt	

### 500BR VS. 500DF COMPARISON

ITEM MODEL	Cutting Tools	Differents for table	Special design	Assistant tools for cutting volume adjustment	Costs for purchase	Consuming cost of tools ( For long-term)
500BR (Original)	Face mill only = Single function	Fixed type	No	Opening wrench + Hexagon wrench	Simple model / Lower costs	High cost
500DF (New model)	Face mill + Wheel = Dual functions	V type + L type (exchangeable), Saving the cutter costs	Dust prevent / Dust removed design / Safety guard of tools	Easy adjusting without any tools	Advance model / Higher costs	Saving half costs

# JT-300A 規則+不規則式倒角機 Inverter Chamfering Machine (Regular+ Irregular)

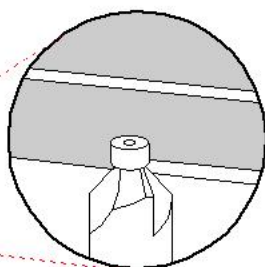

標準配備  
Accessory



選購  
Optional



## 特點 Features :

- A. 採用變頻馬達由0~12000 R.P.M. 以內，可依各種材質進行切割(不含熱處理)。
- B. 針對規則，不規則曲面、內溝、及外形內形輪廓複雜之曲面均可倒角。
- C. 工作零件8mm內徑，內溝寬度8mm或圓弧4R以上皆可倒角。
- D. 倒角能力 0 ~2C，3R以內。
- E. 倒角後工件成45度面。

MODEL	JT-300A
Machine Size	L330xW330xH300mm
Voltage	1Ø, 220V; 50Hz/60Hz
Motor	1HP, 0~12000 r.p.m.
Height of bevel	0~3mm, 45°
N.W. / G.W.	40kgs / 42kgs
Packing	55x44x38cm 3.4 Cuft
Track Size	300x250x12mm

- A. Equipped with inverter motor, range of speed 0~12000 r.p.m.  
Depending on different materials do different chamfering process. (Except heat treatment)
- B. Special for chamfering regular and irregular curving surface, such as inner gap, complex curve surface of inner or outer.
- C. Available for chamfering workpiece with inner diameter and inner gap width with 8mm or radian with 4R or above.
- D. Chamfer ability range: within 0~2C or 3R.
- E. Workpiece with angle 45 degree after chamfered.

訂購編號	品名	規格
02-300A-07	45度成型刀 Carbide end mill	
02-300A-082	捨棄式刀頭 Disposable carbide end mill	(Steel processing use)
02-300A-083	刀片 (1個刀頭需2片刀片) Blade	CPMT060204

## 倒角範例 CHAMFER EXAMPLE

**規則、不規則45度**  
Regular & Irregular angle with 45 degree

內徑倒角 Inner  
外徑倒角 Outer

內、外徑倒角範例  
Inner & Outer chamfered sample

**內、外徑規則、不規則半圓倒角**  
Inner & Outer Regular / Irregular chamfered with half circle angle.

倒角後範例 After  
倒角前範例 Before

**內、外徑規則、不規則倒R角**  
Inner & Outer regular / irregular chamfered with R angle

倒角範例 After

## JT-320B 砂布輪式倒角機 Disk Esper Chamfering Machine



MODEL	JT-320B
Machine Size	L320xW400xH370mm
Voltage	3Ø, 220V/440V, or 1Ø, 110/220V; 50Hz/60Hz
Motor	1HP, 3500 r.p.m.
Height of bevel	0~3mm, 45°
N.W. / G.W.	25kgs / 27kgs
Packing	46x36x38cm, 2.33 Cuft
Track Size	320x120x12mm, 320x28x12mm

訂購編號	品名	規格
02-2DB-803	砂布輪 Disk Esper Emery Wheel	Ø165xØ22mm, 60#

### 特點 Features :

- A. 採用砂布輪切削。
  - B. 適用於鋼鐵、鑄鐵及熱處理零件等材質。
  - C. 不適用於鋁材、軟質鐵材，會有毛邊。
  - D. 如工件本身彎曲，倒角後倒角面也會隨工件彎曲，較不均勻。
- A. Adopt with the disk esper emery wheel chamfering.
  - B. Available for any steel, casting iron, and heat treatment parts materials.
  - C. Unavailable for aluminum, soft iron materials; or which will cause the rough surface happened.
  - D. It is not smoothly after chamfered if the workpeice itself is not straight.

## JT-R6 手提式倒角機 Portable Chamfering Machine



MODEL	JT-R6
Voltage	1Ø, 110V/220V, 50Hz/60Hz
Motor	3000~6000 r.p.m. 1200W
Bevel angle	45°(optional 30degree)
Max.bevel height (45 deg.)	6mm
Min diameter for inside bevels	Ø20mm
N.W. / G.W.	4.6kgs/4.8kgs
Packing	58x37x24cm, 1.82 Cuft

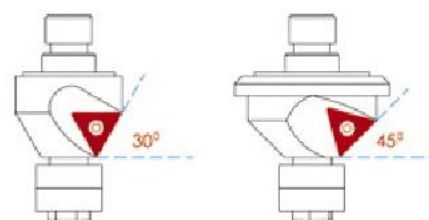

### 特點 Features :

- A. 快速便利予解決角度的增加與調整。
  - B. 可切換速度用於各種材質加工。
  - C. 使用標準三角刀片。
  - D. 可快速更換30°與45°不同角度刀頭。
- A. The quick and convenient solution for adding bevels and deburring.
  - B. Variable speed for working with a variety of materials.
  - C. Uses standard triangle carbide inserts.
  - D. Fast replacement for different cutter from 30°and 45°.

訂購編號	品名	規格
02-2JT-R62	刀頭30度	Cutter 30degree
02-2JT-R63	刀頭45度	Cutter 45degree
02-2JT-R61	刀片Blade	TCMT16T308



## JT-40A 手提倒角機 Portable Chamfering Machine

## JT-40B 手提雕刻機 Portable Engraving Machine

## JT-40A+B 手提倒角雕刻機 Portable Engraving Chamfering Machine

**NEW**



MODEL	JT-40A.JT40B.JT40A+B
Voltage	1PH,110V-240V; 50Hz/60Hz
Motor	500~30000r.p.m. 1/3HP, 250W
Table size	Ø47xØ17
Capacity(Steel Iron)	0~2C (within 1C per time)
Capacity(Aluminum)	0~2C
Flexional Shaft	36" (91.44mm)
Key type drill chuck-JTO	0~4mm
Weight	2.7kgs/3.3kgs
Packing	34x27x14cm

### 特點 Features :

- A. 輕便型，針對不同材質可調整轉速來進行切削。
  - B. 碳刷馬達，小馬力高轉速，較軟材質好切削、速度快。
  - C. 可更換雕刻握把，做為雕刻研磨用。
  - D. 馬達馬力小，切削速度需穩定不可太快，否則會鈍刀。
  - E. 鋼鐵材質的切削量，單次不可超過1mm。
- A. Light and portable type. Variable speed for different materials chamfering.
- B. With carbon brush, lower horsepower and high speed motor.  
It's high speed chamfering, special for soft materials chamfering.
- C. Replaceable engraving handle for both engraving and grinding.
- D. The horsepower is small, it's better to chamfered with stably and slowly speed.
- E. To do the iron steel cutting, the thiknees can not over 1mm for one time processing.

訂購編號	品名	規格
00-2KA-06	倒角握把組(不含刀具) Chamfering handle (Not include cutter)	
00-2KA-07	捨棄式刀頭 Disposable cutter	
02-300A-83	捨棄式刀片 Disposable blade	CPMT060204
00-2KA-09	雕刻握把組(含JTO夾具) Engraving Handle(Include Chuck(JTO))	
00-2KA-04	40A內導線 Flexible shaft(Inner)	
00-2KA-05	40A外軟管 Protection tube	

**JT-C3 手提規則式倒角機** Portable Regular Chamfering Machine (L MODEL ONLY)

**JT-R3 手提不規則式倒角機** Portable Irregular Chamfering Machine

**JT-C3+R3 手提兩用倒角機** Portable Regular+ Irregular Chamfering Machine



HITACHI主機

JT-C3規則式倒角機



HITACHI主機

JT-R3不規則式倒角機

MODEL	JT-C3.R3.C3+R3
Machine Size	L300xW160mm
Voltage	1Ø, 110V/220V, 50Hz/60Hz
Speed	12000r.p.m.
Height of bevel	0~3mm
Length of guide rails	Ø100mm
Min diameter for inside bevels (JT-R3)	Ø16mm
A.M.P	5.9A
Weight	2.7KGS(JT-C3) 2.7KGS(JT-R3)
Packing	37x13.5x13cm, 0.22 Cuft



C3刀頭

訂購編號	品名	規格
02-2HLC-4	刀片(JT-C3) Blade	SPMA321,9.525Square Blade R2
00-2HLC-07	刀頭組(JT-C3) Cutter	
00-2HLC-04	JT-C3直角頭 Guide seat(regular)	100x50x8mm
00-2HLC-054	JT-R3圓盤 Guide seat(irregular)	Ø100xØ30x6mm

**倒角範例 CHAMFER EXAMPLE**



**JT-100C 手提規則式倒角機** Portable Regular Chamfering Machine

**JT-100R 手提不規則式倒角機** Portable Irregular Chamfering Machine

**JT-100C+100R 手提兩用倒角機** Portable Regular+ Irregular Chamfering Machine



JT-C3規則式倒角機

**BOSCH主機**



JT-R3不規則式倒角機



選購  
Optional

MODEL	JT-100C.100R.100C+R
Capacity, Original-L Model	0~3m/m
Capacity, New-V Model	0~5m/m (須加工2次)
Speed	1100r.p.m.
Option speed	Variable speed, 2800~11000r.p.m.
Table size	100x70x8mm
Length of guide rails(100R)	Ø100xØ30x6mm
Min diameter for inside bevels(100R)	Ø20mm
Motor	1Ø, 100V~240V, 50/60Hz
Non Load Motot	670W 6.0A
Weight	2.4KGS/ 2.8KGS
Packing	38x13x14cm
Measurement	0.24 Square feet

**特點 Features :**

- A. 使用平面銑刀切削，刀刃遲鈍時可再利用軌道座的旋轉角度，使刀片再利用，大大的提高了刀片的價值，等於節省一半刀片的價格。
- B. 可有兩種調整模式:舊式L型倒角(圖示一)+新專利-新式V型倒角(圖示二)。
- C. 新式V型倒角一切削時較省力，切削後表面光滑平順，不會起伏不定。

A. Adopt with flat face mill cutting. In order to save the cutter costs.

You can swivel base angle to make the cutter flute to be recycle used.

B. Available for 2 functions adjusting. The original for L type chamfering ( Fig 1 ); the new for V type chamfering ( Fig 2 ).

C. For V type chamfering : save energy. Also the surface of workpeice will be more smoothly after chamfered.

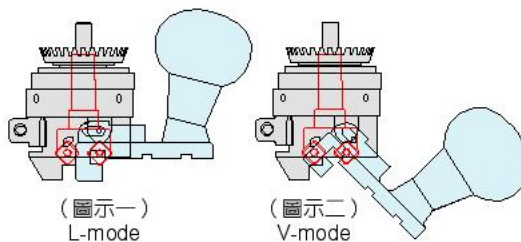

(圖示一)  
L-mode

(圖示二)  
V-mode



選購品  
R角專用刀頭

標準刀頭

2R刀片

3R刀片

訂購編號	品名	規格
00-2HLC100C002	JT-100C刀頭 Cutter	
02-2AB-9155	JT-100R刀頭 Cutter	
00-2HLC-04	JT-100C直角頭 Guide seat(regular)	100x70x8mm
00-2HLC-051	JT-100R圓盤 Guide seat(irregular)	Ø100xØ30x6mm
02-2BE-044	JT-100C刀片 Blade	SPMW0903ADTR
02-2AB-9154	JT-100R刀片2R Blade-2R	
02-2AB-9153	JT-100R刀片3R Blade-3R	

**倒角範例 CHAMFER EXAMPLE**



V型



V型



L型

# JT-200A 手提式倒角機 1HP Portable Chamfering Machine



MODEL	JT-200A
Machine Size	L360xW200xH260mm
Voltage	3Ø, 220V-440V; 50Hz/60Hz
Motor	1HP, 3500r.p.m.
Height of bevel	0-7mm (需分次切削)
Bevel angle	15°~45°
Length of guide rails	Ø200mm
Track Size	200x78x9mm, 200x45x9mm
N.W./G.W.	11kgs/13kgs
Packing	40.5x30x30cm, 1.35 Cuft

## 特點 Features :

- A. 採用側銑刀原理，刀片(共九片)替換迅速。
- B. 適用於任何金屬材料倒角作業。
- C. 軌道座可作15度~45度調整，倒角後工件可成15度~45度面的不同需求。
- D. 倒角能力為0~7C，45度斜邊約10mm寬(需分次切削)。
- A. Adopt with side mill cutting. Quick exchange for knife insert.
- B. Any metal materials are available for chamfering.
- C. Swivel track for adjusting, the range from angle 15°~45° degree.  
Chamfered with side 15°~45° degree for matching different requirement.
- D. The chamfering ability 0~7C, 0~10mm/45°( Chamfering in batches).



標準配備  
Accessory

訂購編號	品名	規格
02-2EB-61	側銑刀頭組 Side Mill Cutter	Ø59xØ17x12.5mm
02-2AB-912	刀片 Blade	SPUN1203x9pcs

## 倒角範例 CHAMFER EXAMPLE

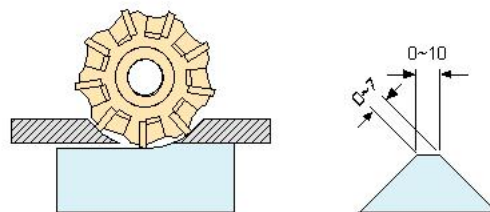

倒角圖示

# JT-250GS 手提式倒角機 2HP Portable Chamfering Machine

**NEW**

CE



MODEL	JT-250GS
Voltage	3Ø, 220V-440V; 50Hz/60Hz
Motor	2HP, 3500r.p.m.
Capacity	0~14C, 0~20mm/45° (需分次切削)
Bevel angle	15~45°
Track Size	250x75x9mm, 250x50x9mm
N.W./G.W.	24kgs/27kgs
Packing	55x42x32cm, 2.61 Cuft

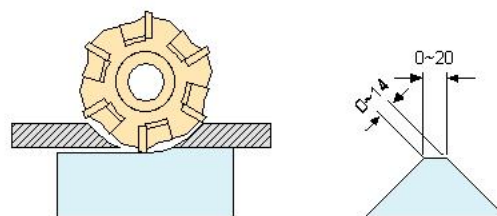

倒角圖示

## 特點 Features :

- A. 採用側銑刀原理, 刀片 (共12片) 替換迅速。
- B. 適用於任何金屬材料倒角作業。
- C. 軌道座可作15度~45度調整、倒角後工件可成15度~45度的不同需求。
- D. 倒角能力為0~14C, 45度斜邊約20mm寬。(需分次切削)
- A. Adopt with side mill cutting. Quick exchange for knife insert
- B. Any metal materials are available for chamfering
- C. Swivel track for adjusting, the range from angle 15~45 degree.  
Chamfered with side 15~45 degree for matching different requirement
- D. The chamfering capacity is 0~14C, 0~20mm/45degree.(Chamfering in batches)



標準配備 (刀頭2個)  
Accessory (Cutter 2pcs)

訂購編號	品名	規格
02-2EC-62	側銑刀頭 Side Mill Cutter	Ø61.5xØ22x12.8
02-2EC-63	側銑刀頭 Side Mill Cutter	Ø61.5xØ22x11.3
02-2EC-65	刀片 Blade	SEKN 120308x12pcs

## JT-12C 自走式倒角機 Self-propelled Chamfering Machine

## JT-18C 自走式倒角機 Self-propelled Chamfering Machine

**NEW**



採用義大利進口馬達及減速機

MODEL	JT-12C
Voltage	220V~380V, 50Hz/60Hz, 3PH
Motor	2HP, 2800rpm/50Hz, 3420rpm/60Hz
Cutting speed	2500~3000/min(Max.)
Height of angle	13mm/45° (carbon steel)
	8mm/45° (stainless steel)
Bevel angle	15°~50°
Work piece thickness	6~40mm

MODEL	JT-18C
Voltage	220V~440V, 50Hz/60Hz, 3PH
Motor	3HP, 2800rpm/50Hz, 3420rpm/60Hz
Cutting speed	2300/min(Max.)
Height of angle	18mm/45° (carbon steel)
	9mm/45° (stainless steel)
Bevel angle	15°~50°
Work piece thickness	6~40mm

### 特點 Features :

- A. 可用於各種金屬板材如:碳鋼、不鏽鋼、鋁、銅等。
- B. 倒角加工快速，每分鐘切削速度可達2500~3000mm以上。
- C. 不需切削油或冷卻油，不污染加工面。
- D. 適用於各種大小板材，大板材可以使倒角機自走加工遷就工作物，小板材倒角機固定工作物遷就機器。
- E. 操作方便，僅用一支固定扳手就可以調整機器的各項功能。
- F. 採用高鋼性鋼板，結構堅固耐久不變型。

A. Applicant: Available for steel, stainless steel, aluminum, copper, plastic and others materials.

B. Quick speed chamfering, 2500~3000mm per minute.

C. No need the coolant oil or cutting oil while chamfering

D. Available for different size of panel.

The large size: Chamfering it is self for work piece

The small size: Fixed way, move the work piece for chamfering.

E. Easy operation, to adjustment each function with only one fixed wrench.

F. Adopt with high-carbon steel .Reliable mode, good construction.



標準配備  
Accessory

訂購編號	品名
02-2JT12C-01	刀具-鋼鐵(中級品) Cutter-STEEL(intensity)
02-2JT12C-02	刀具-鋼鐵(高級品) Cutter-STEEL(high strength)
02-2JT12C-03	刀具-SUS(中級品) Cutter-SUS(intensity)
02-2JT12C-04	刀具-SUS(高級品) Cutter-SUS(high strength)

# 峻廷工業有限公司(合利)

專業製造倒角機

30th  
Since 1981  
TOP-FLIGHT SPECIALIST  
IN CHAMFERING MACHINES

## COMPANY PROFILE

We, Ho Li factory established in July 1981. In 2010 changes the corporate name is

Jiun Ting Industry Ltd.

Jiun Ting (Ho Li) manufactured the Chamfering machines already have more than 30 years experience. We are a leading and professional machine maker. Until now, we developed already have more than 10 models of Chamfering machine and offered them to different area in the world.

Our chamfering machines are for the wide range of industrial products, included the wood, glass, marble and acrylic products... etc.

Chamfering machines main application for Processing Mold Maker, CNC Machine Products Processing and Electrical Parts Processing. For matching different requirements from customer and offering the best quality to customer. Professional, good ability, best high quality and satisfy the customer's requirement are our purpose.

We will be the best one professional Chamfering machine maker in Taiwan you choose.

合利鐵工廠成立於1981年七月。(於2010年更改公司名稱為峻廷工業有限公司)

峻廷(合利)生產倒角機已經有超過30年的經驗了。我們是主要及專業的製造商。

到目前為止，我們已經研發有超過10種以上的型號了，也供應世界各地的客人使用。

我們的倒角機適用於各種不同工業行業的產品，包含：木材、玻璃、大理石、壓克力...等行業。

主要的使用對象為模具加工者、CNC機器產品加工及電子產品的加工。

我們的宗旨是，專業、能力好、品質佳及滿足客戶，以達到符合客戶的需求及提供最佳品質給客人。

我們會是您首選的專業倒角機製造商。



## 峻廷工業有限公司(合利) JIUN TING INDUSTRY LTD.

台灣省台中市大雅區永和路118-15號

NO.118-15 YUNGHO RD., TAYA DIST, TAICHUNG CITY, TAIWAN

TEL:886-4-2566-4846 FAX:886-4-2568-2091

E-mail:holi.com@msa.hinet.net http://www.jiunting.com

Since 1981



## COMPANY PROFILE

**We**, Ho Li factory established in July 1981. In 2010 changes the corporate name is Jiun Ting Industry Ltd.

Jiun Ting (Ho Li) manufactured the Chamfering machines already have more than 30 years experience.

**We** are a leading and professional machine maker. Until now, we developed already have more than 10 models of Chamfering machine and offered them to different area in the world.

**Our** chamfering machines are for the wide range of industrial products, included the wood, glass, marble and acrylic products... etc.

**Chamfering** machines main application for Processing Mold Maker, CNC Machine Products Processing and Electrical Parts Processing. For matching different requirements from customer and offering the best quality to customer. Professional, good ability, best high quality and satisfy the customer's requirement are our purpose.

**We** will be the best one professional Chamfering machine maker in Taiwan you choose.

合利鐵工廠成立於1981年七月。(於2010年更改公司名稱為峻廷工業有限公司)

峻廷(合利)生產倒角機已經有超過 30年的經驗了。我們是主要及專業的製造商。

到目前為止，我們已經研發有超過10種以上的型號了，也供應世界各地的客人使用。

我們的倒角機適用於各種不同工業行業的產品，包含:木材、玻璃、大理石、壓克力...等行業。

主要的使用對象為模具加工者、CNC機器產品加工及電子產品的加工。

我們的宗旨是，專業、能力好、品質佳及滿足客戶，以達到符合客戶的需求及提供最佳品質給客人。

我們會是您首選的專業倒角機製造商。



Since 1981

## 峻廷工業有限公司(合利) JIUN TING INDUSTRY LTD.

台灣省台中市大雅區永和路118-15號

NO.118-15 YUNGHO RD., TAYA DIST, TAICHUNG CITY, TAIWAN

TEL:886-4-2566-4846 FAX:886-4-2568-2091

E-mail:holi.com@msa.hinet.net <http://www.jiunting.com>



# 峻廷工業有限公司(合利)

專業製造倒角機

30<sup>th</sup>

Since 1981

TOP-FLIGHT SPECIALIST  
IN CHAMFERING MACHINES

