



CE ISO 9001

倒角機械專業製造廠
Specialist In A Wide Array of Circular Chamfering Machine

倒角機系列

CHAMFERING
MACHINE

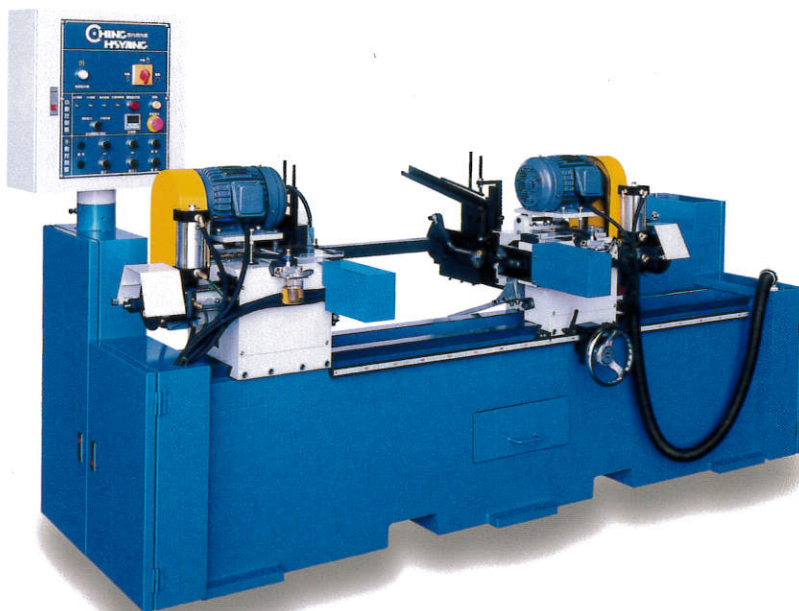



C-60-2A

管料單頭倒角機
SINGLE END CHAMFERING MACHINE

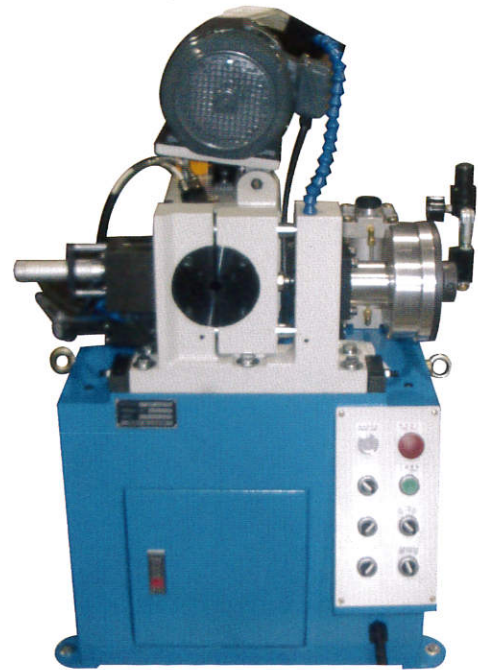
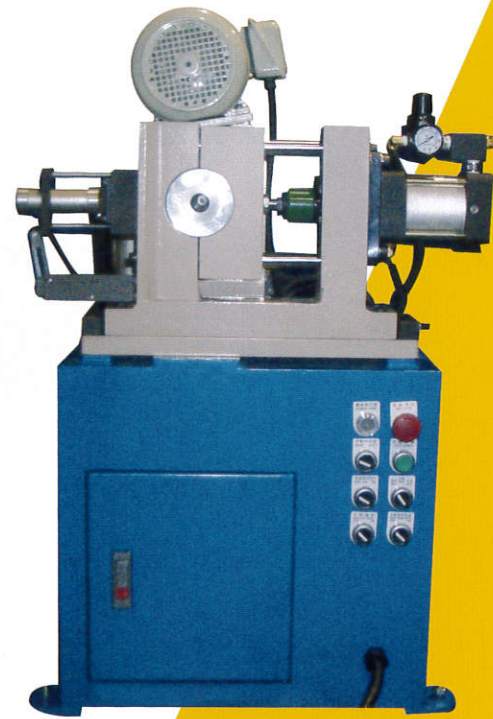

C-80-2A

管料單頭倒角機
SINGLE END CHAMFERING MACHINE

- 另有免換夾模機種
can be option the machine that without changing the clamp



C-120-2A

氣壓半自動型單頭倒角機
PNEUMATIC SEMI AUTOMATIC TYPE
SINGLE END CHAMFERING MACHINE

- 免換夾模
Without changing the clamp

特點 FEATURES

1. 本機專對圓管及圓棒做內外修面動作，圓棒可做倒角動作。
 2. 加工物件與刀盤的中心線準確。
 3. 夾模與刀盤經過精密的設計，可一次均勻的完成加工物件。
 4. 刀盤經特殊設計，刀片規格化，調整刀具簡易快速。
 5. 人工進料，自動進退刀，速度快，適合材質鋼管、鐵管、鋁管、銅管、不銹鋼管。
1. This machine is designed for internal and external shaving of round tubes and round bars, and round bars can be used for chamfering.
 2. The center line of the workpiece and the insert head is accurate.
 3. The clamping die and the cutter head are designed to be uniform, and the workpiece can be processed uniformly at one time.
 4. The cutter head is specially designed, the blade is standardized, and the adjustment tool is simple and fast.
 5. Feeding by manual, automatic advance and retreat blade, fast speed, suitable for material steel pipe, iron pipe, aluminum pipe, copper pipe, stainless steel pipe.

型號 MODEL	C-60-2A	C-80-2A	C-120-2A
主要馬達 Motor	1HP x 4P	2HP x 4P	5HP x 6P
主軸轉速 Speed	2P 3100 / 1550 4P 1550 / 860	1550 / 860	6P 575 / 1035 8P 430 / 775
使用空氣壓力 Working Pressure	6-8 kg/cm ²	6-8 kg/cm ²	6-8 kg/cm ²
使用刀頭 Insert head	標準刀頭 $\phi 20 - \phi 60$ mm	標準刀頭 $\phi 25 - \phi 80$ mm	標準刀頭 $\phi 38 - \phi 115$ mm
適用範圍	小刀頭 $\phi 9 - \phi 18$ mm	小刀頭 $\phi 9 - \phi 25$ mm	
管徑 Pipe O.S.	$\phi 9 - \phi 60$ mm	$\phi 25 - \phi 80$ mm	$\phi 38 - \phi 120$ mm
機台尺寸 Machine Dimensions	780 x 630 x 850 mm	720 x 700 x 1050 mm	950 x 760 x 1350 mm
機台重量 Machine Weight	180kgs	200kgs	250kgs

標準配件 STANDARD ACCESSORIES

- | | |
|----------------------|--|
| 1. 基本機台 | 1. Basic machine |
| 2. 空壓系統 | 2. Pneumatic system |
| 3. 電控系統 | 3. Electrical control system |
| 4. 標準刀頭*1個 | 4. Standard insert head*1 pc |
| 5. 刀座*3個
(內外修面各1) | 5. Insert holder (one each of inner, outer and facing) |
| 6. 刀片*3片
(內外修面各1) | 6. Insert(one each of inner, outer and facing) |
| 7. 夾具*1組 | 7. Clamp*1 set |
| 8. 工具包*1組 | 8. Tools |
| 9. 切削油噴霧系統 | 9. Cutting oil spray system |

特殊配件 OPTIONAL ACCESSORIES

- | | |
|------------|------------------------------|
| 1. 特殊刀頭 | 1. Custom insert head |
| 2. 不同尺寸之夾模 | 2. Clamp of custom size |
| 3. 特殊刀座 | (only for C-60-2A & C-80-2A) |
| 4. R角刀片 | 3. Special insert holder |
| | 4. R angle insert |



■ 料架為特殊配備
Material shelf is optional.

■ 免換夾模
Without changing the clamp

C-180-2A

氣壓半自動型單頭倒角機

PNEUMATIC SEMI AUTOMATIC TYPE SINGLE END CHAMFERING MACHINE



■ 免換夾模
Without changing the clamp

C-300-2A

半自動型單頭倒角機

SEMI AUTOMATIC TYPE SINGLE END CHAMFERING MACHINE

特點 FEATURES

1. 本機專對圓管及圓棒做內外修面動作，圓棒可做倒角動作。
2. 加工物件與刀盤的中心線準確
3. 夾模與刀盤經過精密的設計，可一次均勻的完成加工物件。
4. 刀盤經特殊設計，刀片規格化，調整刀具簡易快速。
5. 人工進料，自動進退刀，速度快，適合材質鋼管、鐵管、鋁管、銅管、不銹鋼管（塑膠管、非金屬材質及碳纖維管）
6. 機台隨機搭配交叉夾模，可適用不同的管徑，節省更換夾模的時間以及成本。

1. This machine is designed for internal and external shaving of round tubes and round bars, and round bars can be used for chamfering.
2. The center line of the processed object and the cutter head is accurate.
3. The clamping die and the cutter head are designed to be uniform, and the workpiece can be processed uniformly at one time.
4. The cutter head is specially designed, the blade is standardized, and the adjustment tool is simple and fast.
5. Feeding by manual, automatic advance and retreat blade, fast speed, suitable for material steel pipe, iron pipe, aluminum pipe, copper pipe, stainless steel pipe (plastic pipe, non-metal material and carbon fiber pipe)
6. The machine is randomly matched with the multiple clamp, which can be applied to different pipe diameters, saving time and cost for replacing the clamp.

型號	MODEL	C-180-2A	C-300-1A	C-300-2A
主機馬達	Motor	A:5HP2P B:5HP 4P C: 3HP 6P	2HP	2HP
主軸轉速	Speed	6P 575 / 1035 8P 430 / 775	20~90 RPM	20~90 RPM
使用空氣壓力	Working Pressure	6-8 kg/cm ²	6-8 kg/cm ²	6-8 kg/cm ²
刀頭適用範圍	Insert Head	小刀頭10~50mm 標準刀頭16~180mm	38~330 MM	38~330 MM
管徑	O.D. Tube diameter	10-180mm	Ø38~330mm	Ø38~330mm
夾具馬力	Clamp motor	-	1/4HP	1/4HP
進刀馬力	Feed Motor	-	-	1/4HP
機器尺寸	Machine Size	855x747x1226mm	1050x1400x1500mm	1050x1400x1500mm
機器重量	Machine Weight	280kgs	1250 kgs	1250 kgs

標準配件 STANDARD ACCESSORIES

- | | |
|----------------------|---|
| 1. 基本機台 | 1. Basic machine |
| 2. 空壓系統 | 2. Pneumatic system |
| 3. 電控系統 | 3. Electrical control system |
| 4. 標準刀頭*1個 | 4. Standard insert head*1 pc |
| 5. 刀座*3個
(內外修面各1) | 5. Insert holder
(one each of inner, outer and facing) |
| 6. 刀片*3片
(內外修面各1) | 6. Insert
(one each of inner, outer and facing) |
| 7. 交叉夾具*1組 | 7. Multiple clamp*1 set |
| 8. 工具包*1組 | 8. Tools |
| 9. 切削油噴霧系統 | 9. Cutting oil spray system |

特殊配件 OPTIONAL ACCESSORIES

- | | |
|---------|--------------------------|
| 1. 特殊刀頭 | 1. Custom insert head |
| 2. 交叉夾模 | 2. Multiple clamp |
| 3. 特殊刀座 | 3. Special insert holder |
| 4. R角刀片 | 4. R angle insert |
| 5. 變頻器 | 5. inverter |



CH-60-3A

管料雙端倒角機 (長料型)

DOUBLE END CHAMFERING MACHINE (LONG TYPE)

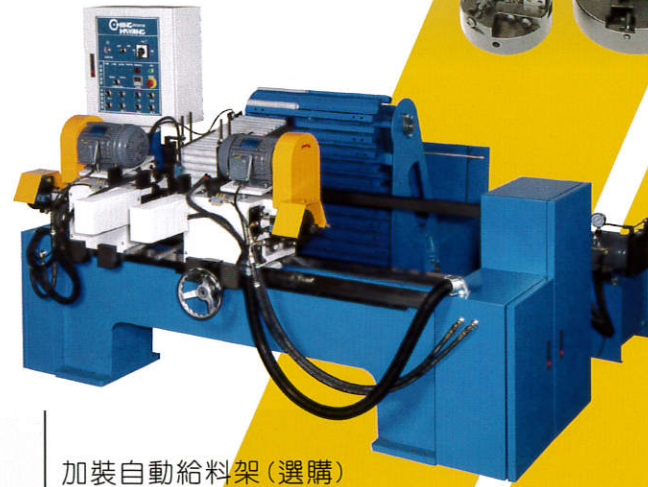

加裝自動給料架 (選購)
Automatic feeder (optional)



CH-60-3AB

管料雙端倒角機 (短料型)

DOUBLE END CHAMFERING MACHINE (SHORT TYPE)

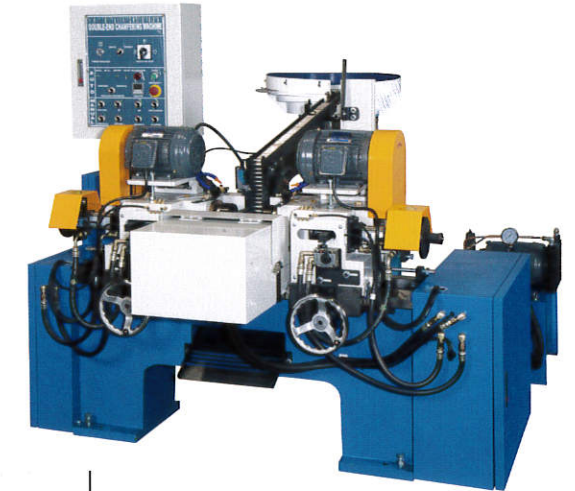

加裝振動給料架 (選購)
Vibrating feeder (optional)

特點 FEATURES

1. 圓管可修內角、外角，修面一次完成，快速精確。
2. 刀盤使用市購刀片更換容易快速。
3. 兩段式進刀，空行程流暢，工作行程可依切削量大小穩定調適。
4. 具手動及自動功能，方便校正調整機器。
5. 特殊自動定位裝置，可自動定位、送料、倒角，可微調長度公差。
6. 油霧潤滑冷卻系統可增加刀片壽命，不卡屑。
7. 進刀終點有暫停調整開關，確保切面平整，工件直角度正確。
8. 車頭軸座加裝磷銅襯套，延長機台使用壽命。

1. A circular tube modifies an interior angle and an external angle at one time with fastness and precision.
2. It's simple and fast to switch the knife because of easy to buy the insert disc in the market.
3. Two-stage of feeding knife, and the idle stroke is smooth. It's available for adjusting the operation stroke according to the cutting volume.
4. There are automatic and manual functions, which are convenient for adjusting the machine.
5. Special automatic positioning device, which can automatically position, feed and chamfer, and fine-tune the length tolerance.
6. Oil mist cooling and lubricating system promotes insert life, and no chips will stay.
7. There is a pause switch at the final point so as to assure the flat plane and the accurate right angle of the work piece.
8. The axle head with phosphor & copper bushing can prolong the life.

標準管端面倒角方式 Chamfer standard pipe end

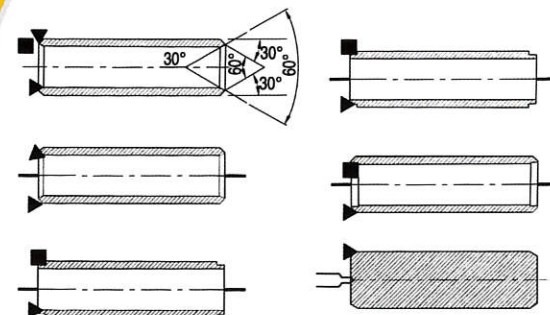

- 本機可簡單的把鐵管端面修成準確的角度。
This machine gives accurate angles at the end of workpieces.

型號 MODEL	C-60-3A	CH-60-3A	CH-60-3AB	CH-80-3AB
主要馬達 Motor	2 x 2HP (1.5kw)	2 x 2HP (1.5kw)	2 x 2HP (1.5kw)	2 x 3HP (2.2kw)
主軸轉速 Cutting Speed	4P 2500 / 1430 6P 1740 / 1000	4P 2500 / 1430 6P 1740 / 1000	4P 2500 / 1430 6P 1740 / 1000	6P 930 / 730 8P 660 / 520
管徑O.D. Tube Diameter	ø12 - ø60mm		ø12 - ø60mm	ø25 - ø80mm
長料型 Long term Type	A:150-1000mm, B:150-1500mm, C:150-2000mm (A為標準型)(A is standard)			
短料型 Short-Term Type				25-230mm
油壓泵 Hydraulic Motor	2HP/20 liter, 20-35KGS		2HP/20 liter, 20-35KGS	
使用空氣壓力 Working Pressure	4-6kg/cm ²			4-6kg/cm ²
機台尺寸 Machine Dimensions	1130 x 2230 x 1600 mm	1130 x 2230 x 1600 mm	1550 x 2100 x 1600 mm	1550 x 2100 x 1600 mm
機台重量 Machine Weight	1460 kg	1310 kg	1310 kg	1450 kg

標準配件 STANDARD ACCESSORIES

1. 主機及傳動系統
 2. PLC自動電控系統
 3. 油壓系統
 4. 標準刀頭2只、刀座3只、刀片3片
 5. 夾具一對
 6. 刀片鎖緊扳手
 7. 工具箱
 8. 切削油噴霧系統
1. Main machine unit & Transmitting system
 2. PLC automatic electronic control system
 3. Hydraulic system
 4. Standard insert head: 2 pcs;
Insert holder: 3 pcs; Insert: 3 pcs
 5. Circular clamp 1 set
 6. Insert clamping wrench
 7. Tool box
 8. Cutting oil spray system

特殊配件 OPTIONAL ACCESSORIES

1. 特殊刀頭
 2. 不同尺寸夾模
 3. 特刀座
 4. 自動送料系統
 5. R角刀片
 6. 變頻器
1. Custom cutter head
 2. Custom circular clamp
 3. Special insert holder
 4. Automatic feeding system
 5. R angle insert
 6. inverter

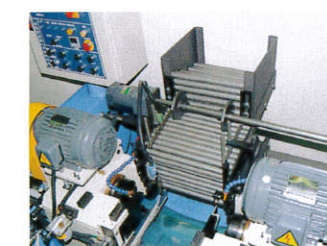

自動送料裝置 (特殊配件)
Auto Feeder (optional accessory)



另有升降式料架可選購
It can be option the lifting rack.

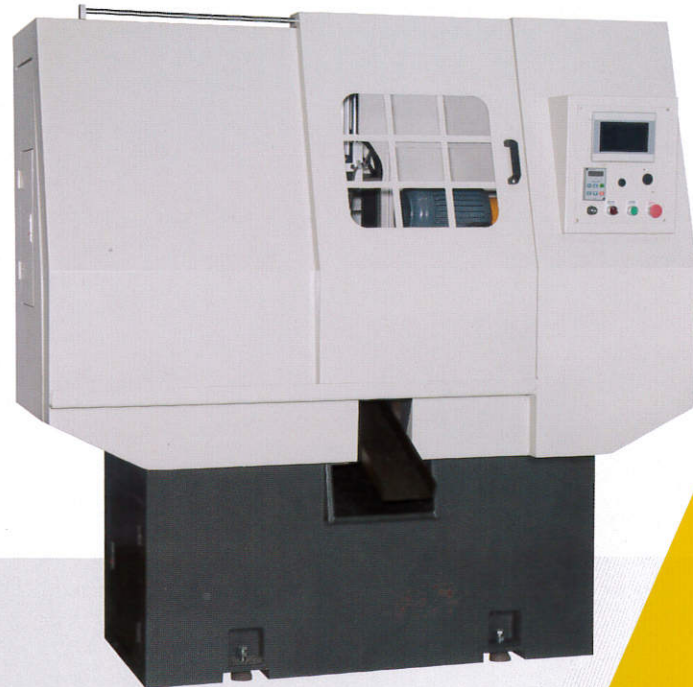

**CH-50-3A
NC-50-3A**

NC 數控型雙端倒角機
NC TYPE DOUBLE END CHAMFERING MACHINE

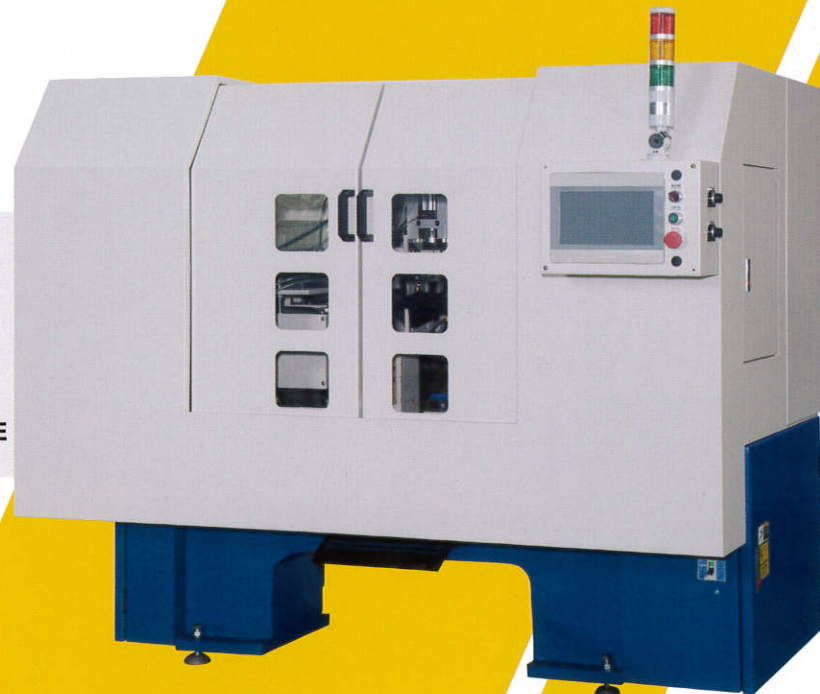

**CH-80-3A
NC-80-3A**

數控型雙端倒角機
NC TYPE DOUBLE END CHAMFERING MACHINE

特點 FEATURES

1. 圓管可修內角、外角、修面一次完成，快速精確
2. 刀盤可使用市購刀片，更換容易快速
3. 兩段式進刀，空行程流暢，工作行程可依切削量大小穩定調適
4. 具手動及自動功能，方便校正調整機器
5. 特殊自動定位裝置，可自動定位、送料、倒角，可微調長度公差
6. 油霧潤滑冷卻系統可增加刀片壽命，不卡屑
7. 伺服馬達進刀，進刀穩定準確
8. 倒角長度由伺服馬達控制，長度可在螢幕上設定、修改
9. 另有機構式長度調整機種（經濟型）

1. The round tube can be repaired inside, outside and repaired at one time, fast and precise.
2. The cutter head can use the commercially available blade, and the replacement is easy and fast.
3. Two-stage feeding, the air stroke is smooth, and the working stroke can be adjusted stably according to the amount of cutting.
4. With manual and automatic functions, it is convenient to adjust and adjust the machine
5. Special automatic positioning device, which can automatically position, feed and chamfer, and fine-tune the length tolerance
6. Oil mist lubrication cooling system can increase blade life without chipping
7. Servo motor feeds, the feed is stable and accurate
8. The chamfer length is controlled by the servo motor, and the length can be set and modified on the screen.
9. Another institutional length adjustment model (economical)

型號	MODEL	CH-50-3A	NC-50-3A	CH-80-3A	NC-80-3A
主機馬達	Motor	2HP*2	2HP*2	2HP*2	2HP*2
主軸轉速	Speed	4P 930/730 6P 660/550	4P 930/730 6P 660/550	4P 930/730 6P 660/550	4P 930/730 6P 660/550
管徑	Pipe O.S.	8~50mm	8~50mm	10~80mm	10~80mm
加工長度	Working Length	10~120mm	10~120mm	15~120mm	15~120mm
刀頭適用範圍	Insert Head	標準刀頭standard Ø25-50mm 特殊刀頭optional Ø8-25mm	標準刀頭standard Ø25-50mm 特殊刀頭optional Ø8-25mm	標準刀頭standard Ø16-80mm 特殊刀頭optional Ø10-16mm	標準刀頭standard Ø16-80mm 特殊刀頭optional Ø10-16mm
油壓馬力	Hydraulic Motor	2HP	2HP	2HP	2HP
使用空氣壓力	Working Pressure	6-8 kg/cm ²	6-8 kg/cm ²	6-8 kg/cm ²	6-8 kg/cm ²
伺服馬達	Servo Motor	-	1KW*2	-	1KW*2
機器尺寸	Machine Dimensions	1535x1890x1936mm	1535x1890x1936mm	1350x1950x1620mm	1350x1950x1620mm
機器重量	Machine Weight	1450kgs	1450kgs	1680kgs	1680kgs

標準配件 STANDARD ACCESSORIES

- | | |
|----------------------|---|
| 1. 主機及傳動系統 | 1. Main machine unit & Transmitting system |
| 2. PLC自動電控系統 | 2. PLC automatic electronic control system |
| 3. 標準刀頭*2個 | 3. Standard insert head*2 pcs |
| 4. 刀座*2組
(內外修面各2) | 4. Insert holder
(two each of inner, outer and facing) |
| 5. 刀片*2組
(內外修面各2) | 5. Insert
(two each of inner, outer and facing) |
| 6. 交叉夾具*1組 | 6. Multiple clamp*1 set |
| 7. 工具箱*1組 | 7. Tool box |
| 8. 切削油噴霧系統 | 8. Cutting oil spray system |

特殊配件 OPTIONAL ACCESSORIES

- | | |
|---------|--------------------------|
| 1. 特殊刀頭 | 1. Custom insert head |
| 2. 特殊刀座 | 2. Special insert holder |
| 3. R角刀片 | 3. R angle insert |
| 4. 變頻器 | 4. inverter |

C-60-4AL

雙端自動倒角機
DOUBLE END CHAMFERING
MACHINE

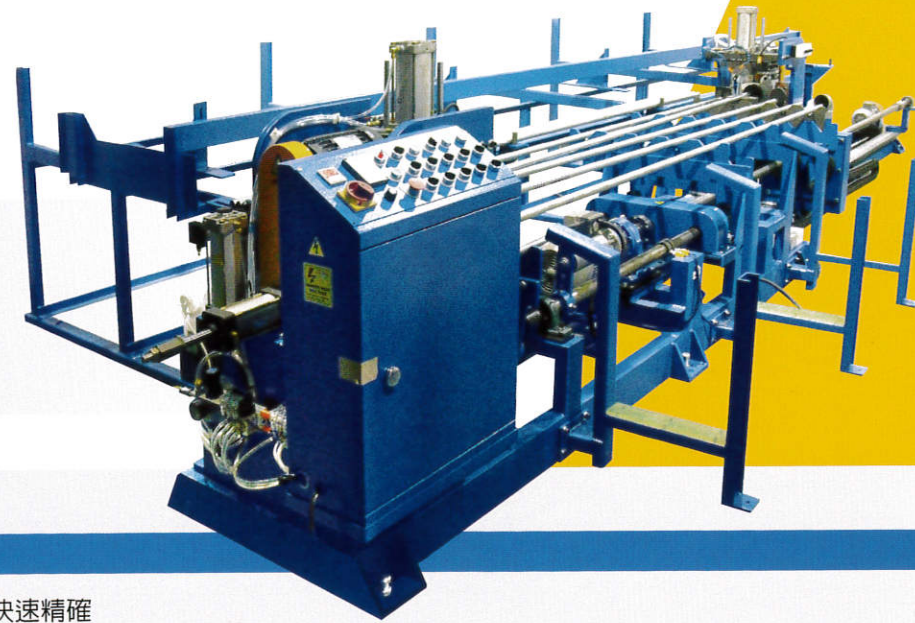

特點 FEATURES

1. 圓管可修內角、外角、修面一次完成，快速精確
2. 刀盤使用市購刀片，更換容易快速
3. 兩段式進刀，空行程流暢，工作行程可依切削量大小穩定調適
4. 具手動及自動功能，方便校正調整機器
5. 特殊自動定位裝置，可自動定位、送料、倒角，可微調長度公差
6. 油霧潤滑冷卻系統，可增加刀片壽命，不卡屑
7. 本機之加工長度可分為A.600mm~3000mm B. 1000mm~6000mm兩種

1. The round tube can be repaired inside, outside and repaired at one time, fast and precise
2. The cutter head uses a commercially available blade, which is easy to replace.
3. Two-stage feeding, the air stroke is smooth, and the working stroke can be adjusted stably according to the amount of cutting.
4. With manual and automatic function, it is convenient to adjust and adjust the machine
5. Special automatic positioning device, which can automatically position, feed and chamfer, and fine-tune the length tolerance
6. Oil mist lubrication cooling system can increase blade life without chipping
7. The machine of the processing length can be divided into two kinds of A.600mm ~ 3000mm B. 1000mm ~ 6000mm

型號	MODEL	C-60-4AL
主機馬達	Motor	2HP*2
主軸轉速	Speed	4P(2500/1430) 6P(1740/1000)
加工長度	Working Length	A:600~3000mm or B:1000~6000mm
管徑	Pipe O.S.	Ø12~Ø60mm
壓縮空氣	Working Pressure	6-8 kg/cm ²
機器尺寸	Machine Dimensions(mm)	3米: 3155x5000x1400mm / 6米:3155x8000x1400mm
機器重量	Machine Weight(Kg)	3米: 1800kgs / 6米:2000kgs

標準配件 STANDARD ACCESSORIES

- | | |
|--------------------------|---|
| 1. 主機及傳動系統 | 1. Main machine unit & Transmitting system |
| 2. PLC自動電控系統 | 2. PLC control system |
| 3. 油壓系統 | 3. Hydraulic system |
| 4. 標準刀頭2個
(含刀座及刀片各2組) | 4. Standard insert head*2 pcs
(including insert holder and insert) |
| 5. 模具*1組 | 5. Clamp*1 set |
| 6. 刀片鎖緊扳手 | 6. Insert clamping wrench |
| 7. 工具箱 | 7. Tool box |
| 8. 切削油噴霧系統 | 8. Cutting oil spray system |

CH-100-2A2

雙頭彎頭修端機
Double head elbow
facing machine

CH-100-2A3

三頭三通修端機
Three-head three-way
facing machine



特點 FEATURES

1. 刀盤使用市購刀片，更換容易快速
2. 兩段式進刀，空行程流暢，工作行程可依切削量大小穩定調適
3. 具手動及自動功能，方便校正調整機器
4. 油霧潤滑冷卻系統，可增加刀片壽命，不卡屑
5. 本機用於修端彎頭、45度彎頭及三通管，也可用於彎管後之修端使用

1. The cutter head uses a commercially available blade, which is easy to replace.
2. Two-stage feeding, the air stroke is smooth, and the working stroke can be adjusted stably according to the amount of cutting.
3. With manual and automatic function, it is convenient to adjust and adjust the machine
4. Oil mist lubrication cooling system can increase blade life without chipping
5. This machine is used for facing elbow, 45 degree elbow and tee, and can also be used for facing after bending.



型號	MODEL	CH-100-2A2 / CH-100-2A3
主機馬達	Motor	3HP(4P)*2 / 3HP(4P)*3
主軸轉速	Speed	4P(930/730)
加工長度	Working Length	100~320mm
管徑	Pipe O.S.	20~120mm
油壓馬力	Hydraulic Motor	3HP
壓縮空氣	Working Pressure	6-8 kg/cm ²
機器尺寸	Machine Dimensions(mm)	2200x1550x1800mm
機器重量	Machine Weight(Kg)	1800kgs

標準配件 STANDARD ACCESSORIES

- | | |
|------------------|--|
| 1. 主機及傳動系統 | 1. Main unit and transmission system |
| 2. PLC自動電控系統 | 2. PLC automatic electronic control system |
| 3. 刀頭2個 (含刀座及刀片) | 3. Insert head*2 pcs(including insert holder and insert) |
| 4. 工具箱 | 4. Tool box |