





Micro Diameter

Type No. 型號	Applicable Insert 適用刀片	尺寸 Dimension					配件 Accessory	
		D	d	L	L1	L2		
WJ14-WCMX03	WCMX030208	14	20	110	42	50	FC5-2510	T8
WJ15-WCMX03	WCMX030208	15	20	113	45	50	FC5-2510	T8
WJ16-WCMX03	WCMX030208	16	20	116	48	50	FC5-2510	T8
WJ17-WCMX03	WCMX030208	17	20	119	51	50	FC5-2510	T8
WJ18-WCMX03	WCMX030208	18	20	122	54	50	FC5-2510	T8
WJ19-WCMX03	WCMX030208	19	20	125	57	50	FC5-2510	T8

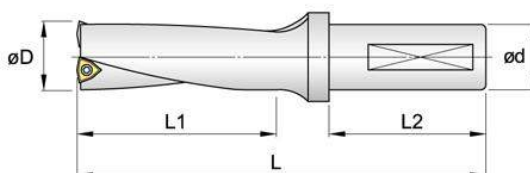

Micro Diameter

Type No. 型號	Applicable Insert 適用刀片	尺寸 Dimension					配件 Accessory	
		D	d	L	L1	L2		
WJ20-WCMX04	WCMX040208	20	25	133	60	55	FC5-2510	T8
WJ21-WCMX04	WCMX040208	21	25	136	63	55	FC5-2510	T8
WJ22-WCMX04	WCMX040208	22	25	139	66	55	FC5-2510	T8
WJ23-WCMX04	WCMX040208	23	25	142	69	55	FC5-2510	T8
WJ24-WCMX04	WCMX040208	24	25	145	72	55	FC5-2510	T8

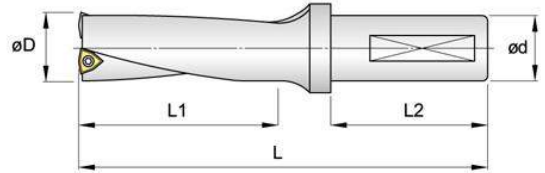

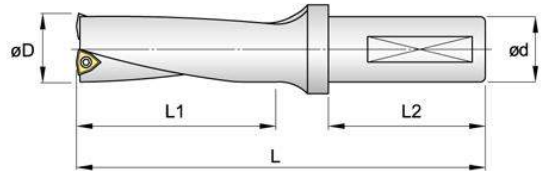

Micro Diameter

Type No. 型號	Applicable Insert 適用刀片	尺寸 Dimension					配件 Accessory	
		D	d	L	L1	L2		
WJ25-WCMX05	WCMX050308	25	25	155	75	60	FC5-3010	T10
WJ26-WCMX05	WCMX050308	26	25	158	78	60	FC5-3010	T10
WJ27-WCMX05	WCMX050308	27	25	161	81	60	FC5-3010	T10
WJ28-WCMX05	WCMX050308	28	25	164	84	60	FC5-3010	T10
WJ29-WCMX05	WCMX050308	29	25	167	87	60	FC5-3010	T10
WJ30-WCMX05	WCMX050308	30	25	170	90	60	FC5-3010	T10



Micro Diameter

Type No. 型號	Applicable Insert 適用刀片	尺寸 Dimension					配件 Accessory	
		D	d	L	L1	L2		
WJ31-WCMX06	WCMX060308	31	32	178	93	60	FC5-3510	T15
WJ32-WCMX06	WCMX060308	32	32	181	96	60	FC5-3510	T15
WJ33-WCMX06	WCMX060308	33	32	184	99	60	FC5-3510	T15
WJ34-WCMX06	WCMX060308	34	32	187	102	60	FC5-3510	T15
WJ35-WCMX06	WCMX060308	35	32	190	105	60	FC5-3510	T15
WJ36-WCMX06	WCMX060308	36	32	193	108	60	FC5-3510	T15
WJ37-WCMX06	WCMX060308	37	32	196	111	60	FC5-3510	T15
WJ38-WCMX06	WCMX060308	38	32	199	114	60	FC5-3510	T15
WJ39-WCMX06	WCMX060308	39	32	202	117	60	FC5-3510	T15

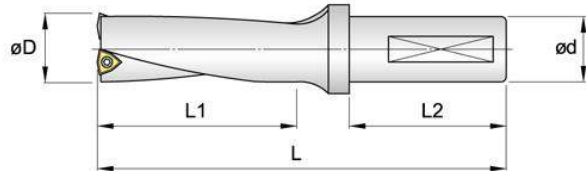

Micro Diameter

Type No. 型號	Applicable Insert 適用刀片	尺寸 Dimension					配件 Accessory	
		D	d	L	L1	L2		
WJ40-WCMX08	WCMX080412	40	40	223	120	70	FC5-4010	T15
WJ41-WCMX08	WCMX080412	41	40	226	123	70	FC5-4010	T15
WJ42-WCMX08	WCMX080412	42	40	229	126	70	FC5-4010	T15
WJ43-WCMX08	WCMX080412	43	40	232	129	70	FC5-4010	T15
WJ44-WCMX08	WCMX080412	44	40	235	132	70	FC5-4010	T15
WJ45-WCMX08	WCMX080412	45	40	238	135	70	FC5-4010	T15
WJ46-WCMX08	WCMX080412	46	40	241	138	70	FC5-4010	T15
WJ47-WCMX08	WCMX080412	47	40	244	141	70	FC5-4010	T15
WJ48-WCMX08	WCMX080412	48	40	247	144	70	FC5-4010	T15
WJ49-WCMX08	WCMX080412	49	40	250	147	70	FC5-4010	T15
WJ50-WCMX08	WCMX080412	50	40	253	150	70	FC5-4010	T15

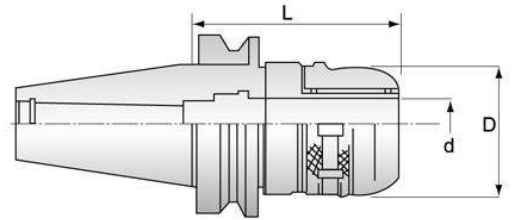

Micro Diameter

Type No. 型號	D	L	C	Collet
BT30-KCH20-80	6-20	80	54	SC20
BT40-KCH20-80	6-20	80	54	SC20
BT40-KCH20-105	6-20	105	54	SC20
BT40-KCH20-135	6-20	135	54	SC20
BT40-KCH32-105	6-32	105	68	SC32
BT50-KCH20-105	6-20	105	54	SC20
BT50-KCH20-135	6-20	135	54	SC20
BT50-KCH20-165	6-20	165	54	SC20
BT50-KCH32-105	6-32	105	68	SC32
BT50-KCH32-135	6-32	135	68	SC32
BT50-KCH32-165	6-32	165	68	SC32
BT50-KCH32-200	6-32	200	68	SC32
BT50-KCH42-105	6-42	105	87	SC42

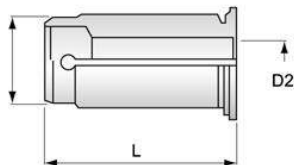

SC筒夾 SC Spring Collets

Type No. 型號	Collet	Model
SC20	6, 8, 10, 12, 14, 16	64
SC32	6, 8, 10, 12, 16, 20, 25	71
SC42	6, 8, 10, 12, 16, 20, 25, 32	80

扳手 Wrench For ASC Milling Chuck W20, W32, W42

Type No. 型號	D1	Chuck
W20	45	ASC20
W32	76	ASC32
W42	76	ASC42

BT30, BT40, BT50 一體式鑽夾頭

BT30, BT40, BT50 Drill Chuck Holder

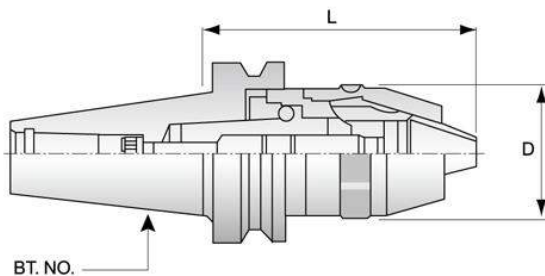

Micro Diameter

Type No. 型號	Clamping Range(ømm)	D	L	
			Minimum	Maximum
BT30-APU08-80	1-8	36.3	75	82
BT30-APU13-100	1-13	51.5	97	104.5
BT40-APU08-80	1-8	36.3	79	86.5
BT40-APU13-100	1-13	51.5	98	109
BT40-APU16-130	3-16	58	116	130
BT50-APU08-95	1-8	36.3	90	97.5
BT50-APU13-120	1-13	51.5	109	120
BT50-APU13-180	1-13	51.5	169	180
BT50-APU16-130	3-16	58	116	130
BT50-APU16-190	3-16	58	176	190

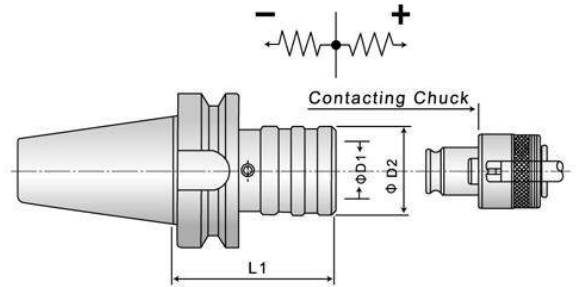

Micro Diameter

Type No. 型號	Capacity 攻牙能力	L1	øD1	øD2	伸縮長度 Length Comp.		Collets 絲攻筒夾
					壓縮Comp.	伸長Tens.	
BT30-WF12	M3~M14	57	19	36	7.5	7.5	TC312
BT30-WF20	M8~M24	95	31	53	12.5	12.5	TC820
BT40-WF12	M3~M14	67	19	36	7.5	7.5	TC312
BT40-WF20	M8~M24	94	31	53	12.5	12.5	TC820
BT40-WF33	M14~M36	163	48	78	20.0	20.0	TC1433
BT50-WF12	M3~M14	100	19	36	7.5	7.5	TC312
BT50-WF20	M8~M24	102	31	53	12.5	12.5	TC820
BT50-WF33	M14~M36	163	48	78	20.0	20.0	TC1433

※ 絲攻筒夾須另購

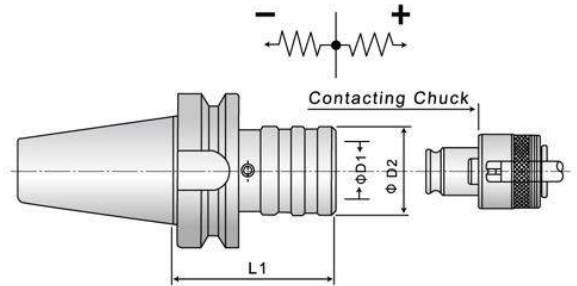

Micro Diameter

Type No. 型號	Capacity 攻牙能力	L1	øD1	øD2	伸縮長度 Length Comp.		Collets 絲攻筒夾
					壓縮Comp.	伸長Tens.	
BT40-WEE12-135	M3~M14	135	19	46	15.0	20.0	TC312
BT40-WEE12-165	M3~M14	165	19	46	15.0	20.0	TC312
BT40-WEE12-135	M3~M14	135	19	46	15.0	20.0	TC312
BT40-WEE12-165	M3~M14	165	19	46	15.0	20.0	TC312
BT40-WEE12-195	M3~M14	195	19	46	15.0	20.0	TC312

※ 絲攻筒夾須另購

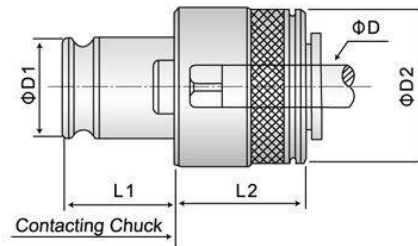

Micro Diameter

Type No. 型號	Capacity 攻牙能力	$\phi D1$	$\phi D2$	L1	L2
TC 312	M2~M14	19.0	32.0	21.5	25.0
TC 820	M8~M24	31.0	50.0	35.0	34.0
TC 1433	M14~M36	48.0	72.0	55.5	45.0

Micro Diameter

JIS絲攻 JIS Tap		攻牙能力 Capacity		訂購編號 Order No.		
		柄徑 ϕD	四方孔口	TC 312(#1)	TC 820(#2)	TC 1433(#3)
M2		3.0	2.5	010-00		
M3	#5, #6	4.0	3.2	010-01		
M4	M4.5 #8	5.0	4.0	010-02		
M5	M5.5 #10	5.5	4.5	010-03		
M6	UNC1/4	6.0	4.5	010-04		
	UNC5/16	6.1	5.0	010-05		
M8	M7	6.2	5.0	010-06	021-01	
M10	M9	7.0	5.5	010-07	020-02	
	M11	8.0	6.0	010-08	020-03	
M12		8.5	6.5	010-09	020-04	
	UNC1/2	9.0	7.0	010-10	020-05	
M14	M15	10.5	8.0	010-11	020-06	030-01
	UNC5/8	12.0	9.0		020-07	030-02
M16		12.5	10.0		020-08	030-03
M18		14.0	11.0		020-10	030-05
M20		15.0	12.0		020-11	030-06
M22		17.0	13.0		020-12	030-07
M24	M25	19.0	15.0		020-13	030-08
M27	M26	20.0	15.0			030-09
M28		21.0	17.0			030-10
	UNC1 1/8	22.0	17.0			030-11
M30		23.0	17.0			030-12
M32		24.0	19.0			030-13
M33		25.0	21.0			030-14
M35	M34	26.0	21.0			030-15
M36		28.0	21.0			030-16
	PT1/8	8.0	6.0	010-12	020-14	
	PT1/4	11.0	9.0	010-13	020-15	030-17
	PT3/8	14.0	11.0		020-16	030-18
	PT1/2	18.0	14.0		020-17	030-19
	PT3/4	23.0	17.0			030-20
	PT1	26.0	21.0			030-21

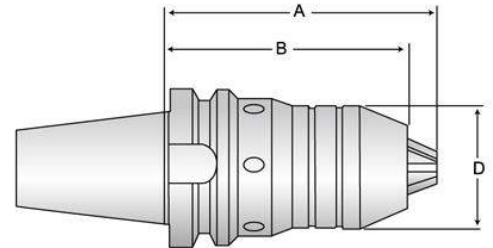

Micro Diameter

Description Code No.	Type No. 型號	攻牙能力 Capacity		A mm	B mm	C mm	N.M.(kg)
		mm	inch				
203008	BT30-SPH08-80	0-8	0-5/16	92	83	38	2.2
203013	BT30-SPH13-100	0-13	0-1/12	115	102	50	2.5
204008	BT40-SPH08-85	0-8	0-5/16	96	87	38	2.4
204013	BT40-SPH13-105	0-13	0-1/12	115	102	50	2.3
204016	BT40-SPH16-110	3-16	1/8-5/8	122	119	57	3.0
205013	BT50-SPH13-115	0-13	0-1/2	127	115	50	5.2
205016	BT50-SPH16-120	3-16	1/8-5/8	133	120	57	6.0

特性:

1. 夾緊力強，達600 kgf-cm。
2. 可雙向使用，特殊設計，鑽孔、攻牙、鉸銑孔，皆可使用。
3. 可適用於主軸轉速6000 RPM以上。

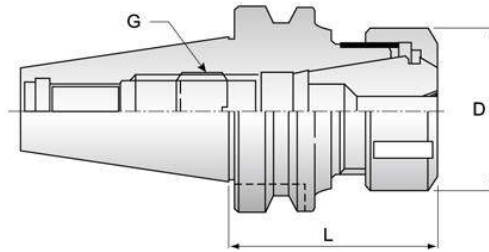

Micro Diameter

※ () 代表M型羅帽

Type No. 型號	Capacity	L	D	Collet Type
BT30-ER16-60	0.5-10	60	28 (22)	ER-16
BT30-ER16-100	0.5-10	100	28 (22)	ER-16
BT30-ER20-60	1-13	60	34 (28)	ER-20
BT30-ER20-100	1-13	100	34 (28)	ER-20
BT30-ER25-60	1-16	60	42	ER-25
BT30-ER25-100	1-16	100	42	ER-25
BT30-ER32-60	2-20	60	50	ER-32
BT30-ER32-100	2-20	100	50	ER-32
BT40-ER16-70	0.5-10	70	28 (22)	ER-16
BT40-ER16-100	0.5-10	100	28 (22)	ER-16
BT40-ER16-150	0.5-10	150	28	ER-16
BT40-ER20-70	1-13	70	34 (28)	ER-20
BT40-ER20-100	1-13	100	34 (28)	ER-20
BT40-ER20-150	1-13	50	34	ER-20
BT40-ER25-70	1-16	70	42	ER-25
BT40-ER25-100	1-16	100	42	ER-25
BT40-ER32-70	2-20	70	50	ER-32
BT40-ER32-100	2-20	100	50	ER-32
BT40-ER32-150	2-20	150	50	ER-32
BT40-ER40-80	3-26	80	63	ER-40
BT40-ER40-100	3-26	100	63	ER-40
BT50-ER16-100	0.5-10	100	28	ER-16
BT50-ER16-150	0.5-10	150	28	ER-16
BT50-ER20-100	1-13	100	34	ER-20
BT50-ER20-150	1-13	150	34	ER-20
BT50-ER25-100	1-16	100	42	ER-25
BT50-ER25-150	1-16	150	42	ER-25
BT50-ER32-100	2-20	100	50	ER-32
BT50-ER32-150	2-20	150	50	ER-32

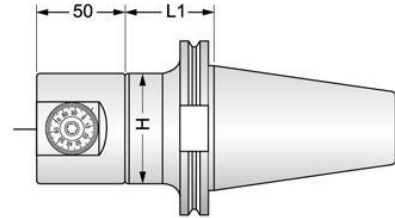

NBJ16微調精搪孔系統

Type No. 型號	加工內徑	H-System	L1
NT40-NBJ16	ø6~ø51	H63	55
NT50-NBJ16	ø6~ø51	H63	65
BT40-NBJ16	ø6~ø51	H63	55
BT50-NBJ16	ø6~ø51	H63	65

Type No. 型號	加工內徑	H-System	L1
SK40-NBJ16	ø6~ø51	H63	60
SK50-NBJ16	ø6~ø51	H63	50
HSK63A-NBJ16	ø6~ø51	H63	60

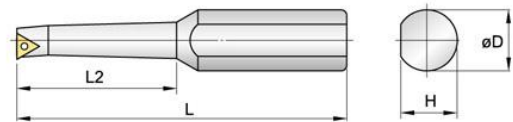

● Ø16 mm NBJ16精搪刀桿盒裝組 8 Pcs Boring Set

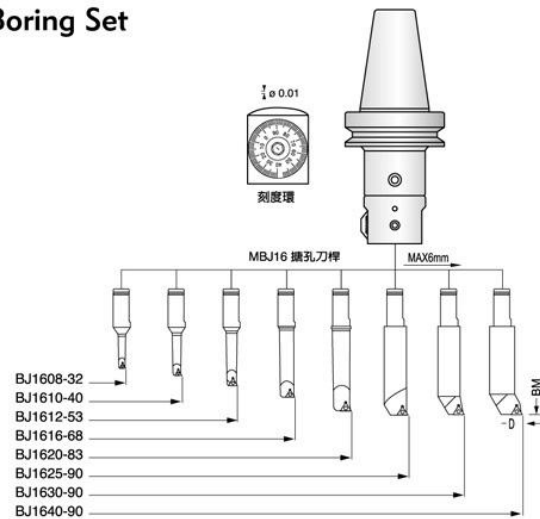

Micro Diameter

Type No. 型號	Applicable Insert 適用刀片	加工內徑	尺寸 Dimension				配件 Accessory	
			D	d	L1	H		
BJ1608-32	TBGT060102L	ø8~ø11	16	80	33.5	15	FC5-2010	T6
BJ1610-40	TBGT060104L	ø10~ø13	16	86.5	41.8	15	FC5-2010	T6
BJ1612-53	TPGH090202L	ø12~ø15	16	98	55.2	15	FC5-2010	T8
BJ1616-68	TPGH090204L	ø16~ø21	16	110	70.8	15	FC5-2010	T10
BJ1620-83	TPGH110302L	ø20~ø26	16	125	85	15	FC5-2010	T10
BJ1625-90	TPGH110302L	ø25~ø31	16	128	90	15	FC5-2010	T10
BJ1630-90	TPGH110304L	ø31~ø40	16	128	90	15	FC5-2010	T10
BJ1640-90	TPGH110304L	ø40~ø50	16	128	90	15	FC5-2010	T10

NBH2084精搪刀桿 Minor Diameter Bore

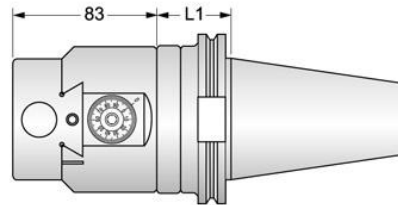

NBH2084微調精搪孔系統

Type No. 型號	加工內徑
R8-NBH2084	ø8~ø280
NT30-NBH2084	ø8~ø280
NT40-NBH2084	ø8~ø280
NT50-NBH2084	ø8~ø280
MT4-NBH2084	ø8~ø280

Type No. 型號	加工內徑
BT40-NBH2084	ø8~ø280
BT50-NBH2084	ø8~ø280
SK40-NBH2084(DIN69871)	ø8~ø280
SK50-NBH2084(DIN69871)	ø8~ø280
MT5-NBH2084	ø8~ø280

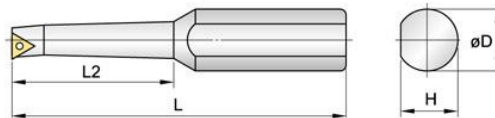

● Ø20 mm NBH2084精搪刀桿盒裝組 8 Pcs Boring Set

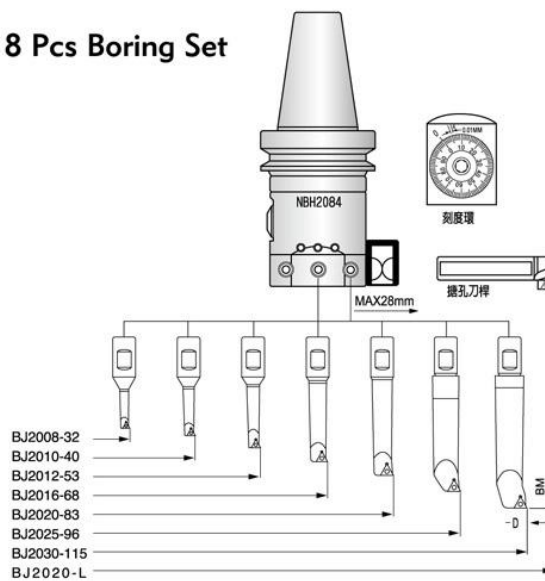

Micro Diameter

Type No. 型號	Applicable Insert 適用刀片	加工內徑	尺寸 Dimension				配件 Accessory	
			D	d	L1	H		
BJ2008-32	TBGT060102L	ø8~ø11	20	75	32	18	FC5-2010	T6
BJ2010-40	TBGT060104L	ø10~ø13	20	75	38	18	FC5-2010	T6
BJ2012-53	TPGH090202L	ø12~ø17	20	85	48	18	FC5-2510	T8
BJ2016-68	TPGH090204L	ø16~ø21	20	100	66	18	FC5-2510	T8
BJ2020-83	TPGH110302L/04L	ø20~ø130	20	115	83	18	FC5-3010	T10
BJ2025-96	TPGH110302L/04L	ø25~ø135	20	128	96	18	FC5-3010	T10
BJ2030-115	TPGH110302L/04L	ø31~ø140	20	147	115	18	FC5-3010	T10
BJ2020-L	TPGH110302L/04L	ø40~ø280	20	97	18	18	FC5-3010	T10

WEY JUAN TECHNOLOGY

New

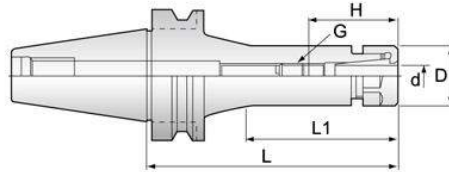

SSK 4°高速精密筒夾 SSK 4° Collet

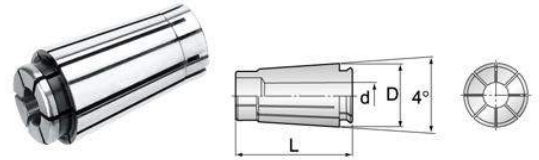

Order Code		D	L
Collet series	Ød		
SSK6	2, 3, 4, 5, 6	10.55	25
SSK10	3, 4, 5, 6, 7, 8, 9, 10	15.6	30
SSK16	4, 5, 6, 7, 8, 9, 10, 11, 12, 13, 14, 15, 16	24.6	45

Type No. 型號	Range (d)	L	L1
BT30-SSK6-60	2-6	60	38
BT30-SSK6-90	2-6	90	50
BT30-SSK10-60	2-10	60	38
BT30-SSK10-90	2-10	90	68
BT30-SSK16-60	3-16	60	38
BT30-SSK16-90	3-16	90	68
BT30-SSK20-60	4-20	60	37
BT30-SSK20-80	4-20	80	37
BT40-SSK6-60	2-6	60	33
BT40-SSK6-90	2-6	90	50
BT40-SSK6-120	2-6	120	50
BT40-SSK10-60	2-10	60	33
BT40-SSK10-90	2-10	90	63
BT40-SSK10-120	2-10	120	70
BT40-SSK10-150	2-10	150	88
BT40-SSK16-60	3-16	60	33
BT40-SSK16-90	3-16	90	63
BT40-SSK16-120	3-16	120	93
BT40-SSK16-150	3-16	150	123
BT40-SSK20-60	4-20	60	33
BT40-SSK20-90	4-20	90	63
BT40-SSK20-120	4-20	120	93
BT40-SSK20-150	4-20	150	123
BT40-SSK25-80	4-25	80	53
BT40-SSK25-120	4-25	120	93
BT50-SSK6-100	2-6	100	50
BT50-SSK6-150	2-6	150	50
BT50-SSK10-100	2-10	100	62
BT50-SSK10-150	2-10	150	70
BT50-SSK16-100	3-16	100	62
BT50-SSK16-150	3-16	150	112
BT50-SSK16-200	3-16	200	162
BT50-SSK20-100	4-20	100	62
BT50-SSK20-150	4-20	150	112
BT50-SSK20-200	4-20	200	162
BT50-SSK25-100	6-25	100	62
BT50-SSK25-150	6-25	150	112
BT50-SSK25-200	6-25	200	162

SDC 小徑後拉高速刀桿 SDC Slim Chuck



NEW

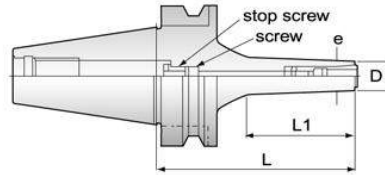

Fig. 1

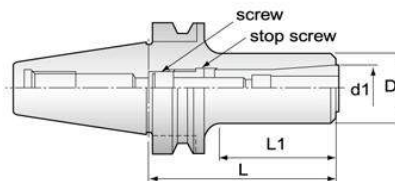
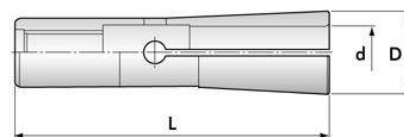

Fig. 2

Type No. 型號	Gripping Range	L	D	Fig	D
BT30-SDC6-60	2-6	60	13	1	DC6
BT30-SDC6-90	2-6	90	13	1	DC6
BT40-SDC6-60	2-6	60	13	1	DC6
BT40-SDC6-90	2-6	90	13	1	DC6
BT40-SDC6-120	2-6	120	13	1	DC6
BT40-SDC6-150	2-6	150	13	1	DC6
BT40-SDC8-90	3-8	90	22	1	DC8
BT40-SDC8-120	3-8	120	22	1	DC8
BT40-SDC10-90	3-10	90	28	2	DC10
BT40-SDC10-120	3-10	120	28	2	DC10
BT40-SDC12-70	3-12	70	34	2	DC12
BT40-SDC12-90	3-12	90	34	2	DC12
BT50-SDC10-110	3-10	110	28	2	DC10

SDC 高速後拉筒夾 SDC Collet (for end mill)



Order Code		L	ØD
Collet series	Ød		
SDC6	3, 4, 6	36	9.6
SDC8	3, 4, 6, 8	45	15
SDC10	3, 4, 6, 8, 10	52	19.1
SDC12	3, 4, 5, 6, 8, 10, 12	60	22

WEY JUAN TECHNOLOGY



Micro Diameter

Type No. 型號	Capacity	Collet Set
NT30-KCH20	6-20	6, 8, 10, 12, 16
NT40-KCH32	6-32	6, 8, 10, 12, 16, 20, 25
NT50-KCH32	6-32	6, 8, 10, 12, 16, 20, 25



Micro Diameter

Type No. 型號	Capacity	Collet Set
NT30-OZ25	3-25	7 PS : 6, 8, 10, 12, 16, 20, 25
NT30-OZ25		15PS : 3, 4, 5, 6, 7, 8, 9, 10, 11, 12, 13, 16, 18, 20, 25
NT40-OZ25		
NT40-OZ32	6-32	8 PS : 6, 8, 10, 12, 16, 20, 25, 32
NT50-OZ32		15PS : 6, 7, 8, 9, 10, 11, 12, 13, 14, 15, 16, 18, 20, 25, 32

ER 筒夾 ER Spring Collets



Micro Diameter

ER11		ER20		ER25		ER32		ER40	
Ordering Code	Range (mm)	Ordering Code	Range (mm)	Ordering Code	Range (mm)	Ordering Code	Range (mm)	Ordering Code	Range (mm)
ER11-1.0	1.0-0.5	ER20-2	2-1	ER25-2	2-1	ER32-3	3-2	ER40-4	4-3
ER11-1.5	1.5-1.0	ER20-3	3-2	ER25-3	3-2	ER32-4	4-3	ER40-5	5-4
ER11-2.0	2.0-1.5	ER20-4	4-3	ER25-4	4-3	ER32-5	5-4	ER40-6	6-5
ER11-2.5	2.5-2.0	ER20-5	5-4	ER25-5	5-4	ER32-6	6-5	ER40-7	7-6
ER11-3.0	3.0-2.5	ER20-6	6-5	ER25-6	6-5	ER32-7	7-6	ER40-8	8-7
ER11-3.5	3.5-3.0	ER20-7	7-6	ER25-7	7-6	ER32-8	8-7	ER40-9	9-8
ER11-4.0	4.0-3.5	ER20-8	8-7	ER25-8	8-7	ER32-9	9-8	ER40-10	10-9
ER11-4.5	4.5-4.0	ER20-9	9-8	ER25-9	9-8	ER32-10	10-9	ER40-11	11-10
ER11-5.0	5.0-4.5	ER20-10	10-9	ER25-10	10-9	ER32-11	11-10	ER40-12	12-11
ER11-5.5	5.5-5.0	ER20-11	11-10	ER25-11	11-10	ER32-12	12-11	ER40-13	13-12
ER11-6.0	6.0-5.5	ER20-12	12-11	ER25-12	12-11	ER32-13	13-12	ER40-14	14-13
ER11-6.5	6.5-6.0	ER20-13	13-12	ER25-13	13-12	ER32-14	14-13	ER40-15	15-14
ER11-7.0	7.0-6.5			ER25-14	14-13	ER32-15	15-14	ER40-16	16-15
ER16				ER25-15	15-14	ER32-16	16-15	ER40-17	17-16
ER16-1	1-0.5			ER25-16	16-15	ER32-17	17-16	ER40-18	18-17
ER16-2	2-1					ER32-18	18-17	ER40-19	19-18
ER16-3	3-2					ER32-19	19-18	ER40-20	20-19
ER16-4	4-3					ER32-20	20-19	ER40-21	21-20
ER16-5	5-4							ER40-22	22-21
ER16-6	6-5							ER40-23	23-22
ER16-7	7-6							ER40-24	24-23
ER16-8	8-7							ER40-25	25-24
ER16-9	9-8							ER40-26	26-25
ER16-10	10-9								

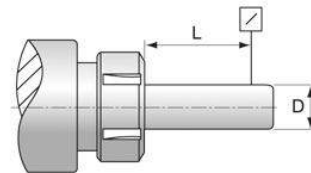
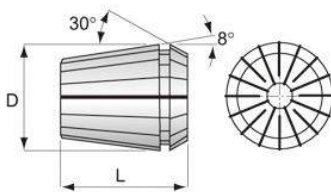

Collet Dimensions

Type No. 型號	ER11	ER16	ER20	ER25	ER32	ER40
D	11.5	17	21	26	33	41

Concentricity of Collet DIN 6499

D (mm)	D (mm)	DIN 6499		
		Class2	Class1	ClassG
6	1.0-1.4	0.015	0.01	0.005
10	1.5-2.9			
16	3.0-5.9			
25	6.0-9.9			
40	10.0-17.9	0.02	0.015	0.01
50	18.0-26.9			

WEY JUAN TECHNOLOGY

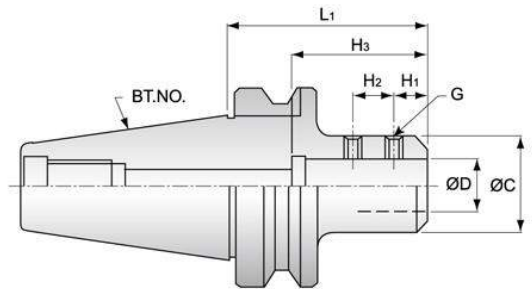

Micro Diameter

Type No. 型號	D	C	H	L	H1	H2	H3
BT30-SLA6-60	6	25	32	60	10	10	M6
BT30-SLA8-60	8	28	36	60	12	12	M8
BT30-SLA10-60	10	35	40	60	15	12	M8
BT30-SLA12-60	12	40	45	60	18	16	M10
BT30-SLA16-75	16	45	50	75	20	18	M10
BT30-SLA20-75	20	50	60	75	25	20	M12
BT30-SLA25-75	25	55	65	75	24	25	M12
BT40-SLA6-75	6	25	32	75	10	10	M6
BT40-SLA8-75	8	28	36	75	12	12	M8
BT40-SLA10-75	10	35	40	75	15	12	M8
BT40-SLA12-75	12	40	45	75	18	16	M10
BT40-SLA14-75	14	42	45	75	18	16	M10
BT40-SLA16-75	16	45	50	75	20	18	M10
BT40-SLA18-75	18	48	50	75	20	18	M12
BT40-SLA20-75	20	50	60	75	25	20	M12
BT40-SLA25-75	25	60	65	75	24	25	M16
BT40-SLA32-90	32	60	70	90	24	28	M16
BT40-SLA40-105	40	80	80	105	24	28	M16
BT40-SLA42-105	42	80	80	105	24	28	M20
BT50-SLA6-105	6	25	32	105	10	10	M6
BT50-SLA8-105	8	28	36	105	12	12	M8
BT50-SLA10-105	10	35	40	105	15	12	M8
BT50-SLA12-105	12	40	45	105	18	16	M10
BT50-SLA14-105	14	42	45	105	18	16	M10
BT50-SLA16-105	16	45	50	105	20	18	M10
BT50-SLA18-105	18	48	55	105	20	18	M10
BT50-SLA20-105	20	50	60	105	25	20	M12
BT50-SLA20-150	20	50(40)	60	150	25	20	M12
BT50-SLA20-200	20	50(40)	60	200	25	20	M12
BT50-SLA25-105	25	60	60	105	25	22	M16
BT50-SLA25-150	25	60(50)	65	150	24	25	M16
BT50-SLA25-200	25	60(50)	65	200	24	25	M16
BT50-SLA25-250	25	60(50)	65	250	24	25	M16
BT50-SLA32-105	32	60	70	105	24	28	M20
BT50-SLA32-150	32	60(50)	70	150	24	28	M20
BT50-SLA32-200	32	60(50)	70	200	24	28	M20
BT50-SLA32-250	32	60(50)	70	250	24	28	M20
BT50-SLA40-105	40	80	80	105	30	32	M20
BT50-SLA42-105	42	80	80	105	30	32	M20
BT50-SLA42-150	42	80	80	150	30	32	M20
BT50-SLA42-200	42	80	80	200	30	32	M20
BT50-SLA50.8-120	50.8	95	90	120	30	32	M20

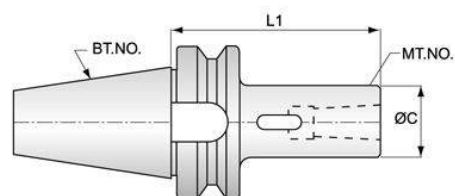
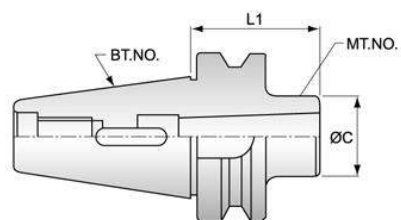

Micro Diameter

Type No. 型號	Fig	MT. No.	Ø C	L1
BT30-MT1-45	1	MT1	25	45
BT30-MT2-60	1	MT2	32	60
BT30-MT3-80	1	MT3	40	80
BT40-MT1-45	1	MT1	25	45
BT40-MT1-120	2	MT1	25	120
BT40-MT2-45	1	MT2	32	45
BT40-MT2-120	2	MT2	32	120
BT40-MT3-75	1	MT3	40	75
BT40-MT3-135	2	MT3	40	135
BT40-MT4-90	1	MT4	50	90
BT50-MT1-45	1	MT1	25	45
BT50-MT1-120	2	MT1	25	120
BT50-MT1-180	2	MT1	32	180
BT50-MT2-45	1	MT2	32	45
BT50-MT2-135	2	MT2	32	135
BT50-MT2-185	2	MT2	32	185
BT50-MT3-45	1	MT3	40	45
BT50-MT3-150	2	MT3	40	150
BT50-MT3-180	2	MT3	40	180
BT50-MT4-75	1	MT4	50	75
BT50-MT4-180	2	MT4	50	180
BT50-MT5-105	1	MT5	65	105
BT50-MT5-210	2	MT5	65	210

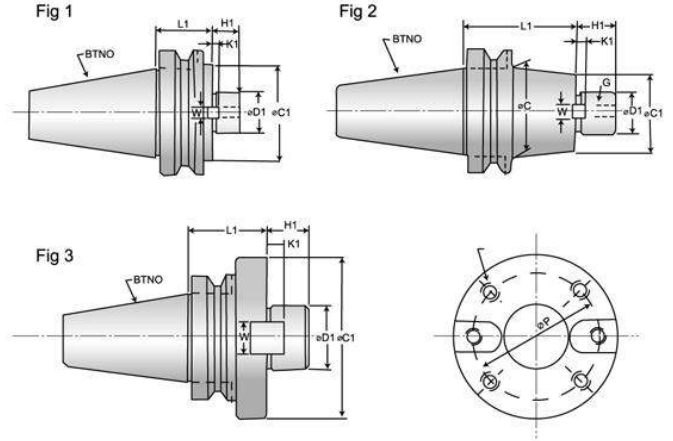

Micro Diameter

※ () 代表特殊尺寸

Type No. 型號	Fig	D1	L1	H1	G	W1	C-C1
BT30-FMA25.4-45,60	1	25.4	45, 60	20	M12	9.5	45
BT40-FMA25.4-45,60	1	25.4	45, 60	20	M12	9.5	55
BT40-FMA25.4-90,105	2	25.4	90, 105	20	M12	9.5	62-55
BT40-FMA25.4-125,105	2	25.4	125, 150	20	M12	9.5	62-55
BT40-FMA31.75-45,75	1	31.75	45, 75	22	M12	12.7	62
BT40-FMA31.75-105,125	2	31.75	105, 125	22	M12	12.7	70-62
BT40-FMA38.1-60	3	38.1	60	23	M16	15.9	80
BT50-FMA25.4-45,75	1	25.4	45, 75	20	M12	9.5	60
BT50-FMA25.4-105,125	2	25.4	105, 125	20	M12	9.5	60
BT50-FMA25.4-150	2	25.4	150	20	M12	9.5	63-58
BT50-FMA25.4-200	2	25.4	200	20	M12	9.5	63-58(68-60)
BT50-FMA25.4-250	2	25.4	250	20	M12	9.5	63-58(70-60)
BT50-FMA25.4-300	2	25.4	300	20	M12	9.5	63-58(72-60)
BT50-FMA31.75-45,75	1	31.75	45, 75	22	M16	12.7	70
BT50-FMA31.75-105	2	31.75	105	22	M16	12.7	75-70
BT50-FMA31.75-125	2	31.75	125	22	M16	12.7	75-70
BT50-FMA31.75-150	2	31.75	150	22	M16	12.7	75-70
BT50-FMA31.75-200	2	31.75	200	22	M16	12.7	75-70
BT50-FMA38.1-45,75	1	38.1	45, 75	23	M16	15.9	85
BT50-FMA38.1-105	2	38.1	105	23	M16	15.9	85-80
BT50-FMA38.1-125	2	38.1	125	23	M16	15.9	85-80
BT50-FMA38.1-150	2	38.1	150	23	M16	15.9	85-50
BT50-FMA50.8-45,75	1	38.1	45, 75	24	M16	19.05	95
BT50-FMA50.8-105	2	50.8	105	24	M16	19.05	95
BT50-FMA50.8-125	2	50.8	125	24	M16	19.05	95
BT50-FMA50.8-150	2	50.8	150	24	M16	19.05	95
BT50-FMA47.625-75	3	47.625	75	32	-	25.4	128.57

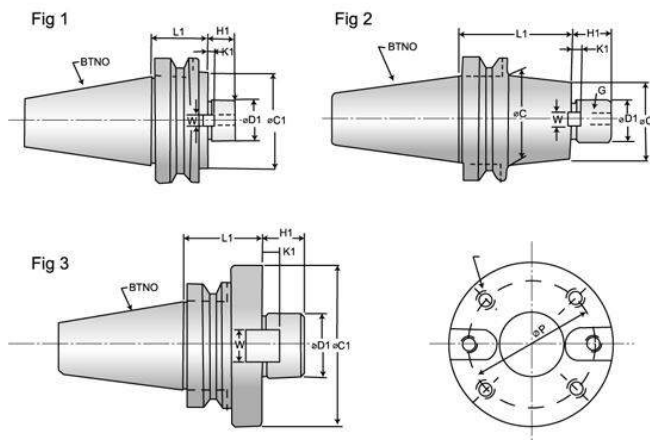

Micro Diameter

Type No. 型號	Fig	D1	L1	H1	H2	W	G
BT30-FMB22-45	1	22	45	18	4	10	M10
BT30-FMB27-45	1	27	45	20	4	12	M12
BT40-FMB22-60	1	22	60	18	4	10	M10
BT40-FMB22-105	2	22	105	18	4	10	M10
BT40-FMB27-60	1	27	60	20	4	12	M12
BT40-FMB27-105	1	27	105	20	4	12	M12
BT40-FMB32-60	1	32	60	21	4	14	M16
BT40-FMB32-105	1	32	105	21	4	14	M16
BT40-FMB40-60	1	40	60	23	4	16	M16
BT50-FMB22-60	1	22	60	18	4	10	M10
BT50-FMB22-105	2	22	105	18	4	10	M10
BT50-FMB22-125	2	22	125	18	4	10	M10
BT50-FMB22-150	2	22	150	18	4	10	M10
BT50-FMB22-200	2	22	200	18	4	10	M10
BT50-FMB22-250	2	22	250	18	4	10	M10
BT50-FMB27-60	1	27	60	20	4	12	M12
BT50-FMB27-105	1	27	105	20	4	12	M12
BT50-FMB27-125	2	27	125	20	4	12	M12
BT50-FMB27-150	2	27	150	20	4	12	M12
BT50-FMB32-60	1	32	60	21	4	14	M16
BT50-FMB32-105	1	32	105	21	4	14	M16
BT50-FMB32-150	2	32	150	21	4	14	M16
BT50-FMB40-60	1	40	60	23	4	16	M16
BT50-FMB40-105	1	40	105	23	4	16	M16
BT50-FMB40-150	1	40	150	23	4	16	M16
BT50-FMB60-75	3	60	75	32	4	25.4	-

WEY JUAN TECHNOLOGY

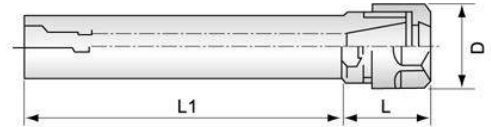

Straight Shank C20, C25, C32, C40

Type No. 型號	L1	L	D
C20-ER16-50	50	30	28
C20-ER16-100	100	30	28
C20-ER16-150	150	30	28
C20-ER20-50	50	36	34
C20-ER20-100	100	36	34
C20-ER20-150	150	36	34
C20-ER25-50	50	46	42
C20-ER25-100	100	46	42
C20-ER25-150	150	46	42
C25-ER16-100	100	30	28
C25-ER16-150	150	30	28

Type No. 型號	L1	L	D
C25-ER20-150	150	36	34
C25-ER25-100	100	46	42
C25-ER25-150	150	46	42
C25-ER32-80	80	54	50
C25-ER40-100	100	55	63
C32-ER25-60	60	46	42
C32-ER32-100	100	54	50
C32-ER40-100	100	55	63
C40-ER32-100	100	54	50
C40-ER40-100	100	55	63



直柄ER夾頭組

本體 D1 x L1	筒夾型號	筒夾規格
ø 20 x L50	ER16 夾持能力 ø0.5 ~ ø10	1 ~ 0.5
		2 ~ 1
		3 ~ 2
		4 ~ 3
ø 20 x L100		5 ~ 4
		6 ~ 5
ø 20 x L150		8 ~ 7
		9 ~ 8
ø 20 x L200		10 ~ 9
		共10只

本體 D1 x L1	筒夾型號	筒夾規格	
ø 20 x L50	ER20 夾持能力 ø1 ~ ø13	2 ~ 1	
		3 ~ 2	
		4 ~ 3	
		6 ~ 5	
ø 20 x L100		7 ~ 6	
		8 ~ 7	
ø 20 x L150		9 ~ 8	
		11 ~ 10	
ø 20 x L200		12 ~ 11	
		13 ~ 12	
			共12只

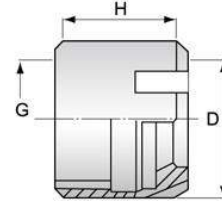

螺母系列 Clamping Nuts

Type No. 型號	Fig.	D	H	G	Collet Type
CN11	1	19	13	M14XP0.75	ER11
CN16	1	28	17.5	M22XP1.5	ER16
CN20	1	34	19	M25XP1.5	ER20
CN25	2	42	20	M32XP1.5	ER25
CN32	2	50	22.5	M40XP1.5	ER32
CN40	2	63	29	M50XP1.5	ER40
CNM11	3	16	12	M13XP0.75	ER11
CNM16	3	22	18	M19XP1.0	ER16
CNM20	3	28	19	M24XP1.0	ER20

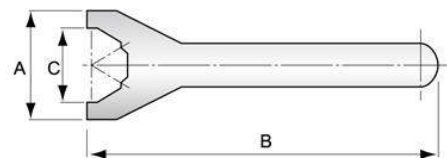

扳手系列 Wrench Series

Type No. 型號	Fig.	A	C	B	Collet Type
W16		45	25	137	ER16
W20		54	30	162	ER20
W25	1	65	37	206	ER25
W32	1	75	46.5	253	ER32
W40	1	90	58	289	ER40
Wm11	2	17	8.5	95	ER11
Wm16	2	22.5	12.5	117	ER16
Wm20	2	28.5	15.5	129	ER20

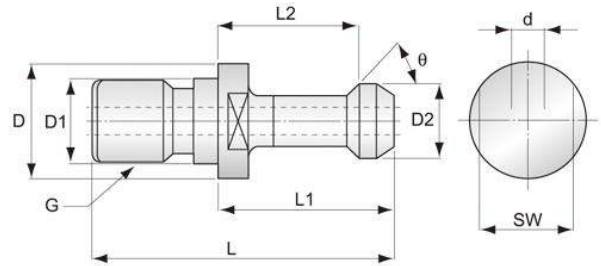

Micro Diameter

Type of Pull Stud 型號	L	L1	L2	D	D1	D2	θ	G	SW
P30T-1	43	23	18	16.5	12.5	11	45°	M12	13
P30T-2	43	23	18	16.5	12.5	11	60°	M12	13
P40T-1	60	35	28	23	17	15	45°	M16	19
P40T-2	60	35	28	23	17	15	60°	M16	19
P40T-90	60	35	28	23	17	15	90°	M16	19
P50T-1	85	45	35	38	25	23	45°	M24	30
P50T-2	85	45	35	38	25	23	60°	M24	30
P50T-90	85	45	35	38	25	23	90°	M24	30



刀庫主軸清潔棒 (可替換式片) Spindle Taper Wipers

Type No. 型號	Taper No. 型號
CL-30	#30
CL-40	#40
CCL-50	#50



Vertical/Horizontal BT Tool Holder Locking Device

立橫兩用BT刀軸鎖刀座

BT30, BT40, BT50三種規格。

特性：

1. 操作簡單，刀軸容易固定。
2. 立式、橫式兩用。
3. 不需再調整角度即可使用。
4. 置刀架使用鋁合金，保護刀把。