

ARC/HRC/ERC Standard 4-Row Ball Bearing Linear Guide  
 WRC Wide 4-Row Ball Bearing Linear Guide  
 ARR/HRR/LRR Standard 4-Row Roller-type Linear Guide

\* cpc reserves the right to revise any information(technical details) any time without notice, for printing mistakes or any other incidental mistakes. We take no responsibility.



## Contents

### ARC/HRC/ERC Standard 4-Row Ball Bearing Linear Guide

ARC/HRC/ERC Overview .....	P01 -P02
Product Design (Standard).....	P03 -P04
Product Design (Option).....	P07 -P10
Installation Notice.....	P11
Technical Information.....	P12 -P13
Ordering Information.....	P14
Dimension Table.....	P15 -P22

### AR/HR/ER Lightweight Ball Bearing Linear Guide

AR/HR/ER Overview .....	P23
Technical Information.....	P24
Ordering Information.....	P24
Dimension Table.....	P25 -P27

### WRC Wide 4-Row Ball Bearing Linear Guide

Ordering Information.....	P28
Dimension Table.....	P28 -P30

### ARR/HRR/LRR 4-Row Roller-type Linear Guide

Product Design .....	P31 -P32
Ordering Information.....	P32
Dimension Table.....	P33 -P40

### Grease Nipple Option

Grease Nipple Option.....	P41 -P44
---------------------------	----------

### Lubrication Storages Pad Testing Report

Lubrication Storages Pad Test Report.....	P45
---	-----

## Product Overview

### ARC/HRC/ERC Product Characteristics

Our standard **cpc** ARC/HRC/ERC Linear Guide Series uses the O-type arrangement for its four-row ball circulation design. The 45-degree contact angle between the rails and balls allows our product to realize a four-directional equivalent load effect. **cpc** has placed special emphasis on strengthening the arm length ( $L_o$ ) of our product so that when sustaining external force ( $F$ ), this can have an even higher  $M_r$  value, which increases its rigidity and torsion-resistant capabilities. The larger and more numerous balls in our products allows it to have a 10-30% greater load capacity than similarly sized competitor products. These and other characteristics are the source of our product's high load capacity, moment, and stiffness features.

Mode Code	$L_o$	$H_c$
15	12.4	9.35
20	16.4	12.5
25	19.5	14.5
30	24.0	17
35	30.4	19.5
45	38.2	24
55	43.1	28.5

$F = M_r / L_o (L_x)$

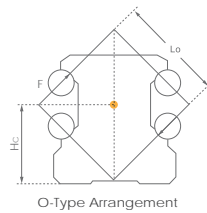

O-Type Arrangement

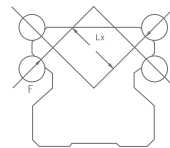

X-Type Arrangement

#### Stainless steel reinforcement plate

- Total scraping of external objects above 0.3mm
- Increased X-axis axial force capacity

#### Inner Lubrication storage Pad (Upper)

- No need to increase the length of the runner block
- Full lubrication contact with balls, particularly suitable for short stroke movement.

#### End Cap

- All-around lubrication holes system

#### High abrasion resistant material end seal

- Standard contactless, low friction, high dust proof seal

#### Inner Lubrication storage Pad (Bottom)

#### Ball chain

- Patented design to enable reverse operations.
- Muted and prolonged service life

- High Load and torque capabilities
- Excellent dynamic performance: Reach  $V_{max}$  10 m/s    Reach  $a_{max}$  450 m/s<sup>2</sup>
- Can provide counterbored holes from the top and tapped mounting holes from the bottom rail
- Can provide specialized steel surface treatment

## Product Design

(Standard)

### Dustproof design

#### Inner Seals

The newly designed inner seals both protect the rails from foreign particles and keep the lubrication inside the runner block, while maintaining a low friction profile.

#### Bottom Seals

The bottom seals work in conjunction with the inner seals to keep foreign particles out and lubrication from leaking out. Our comprehensive sealing design significantly reduces re-lubrication needs and prolongs service life of the runner block.

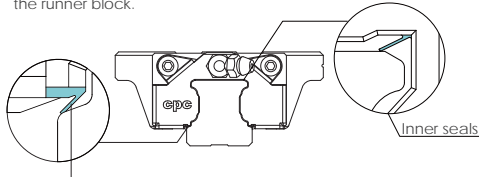

Bottom Seals

#### End Seals

The end seals work in conjunction with the bottom and inner seals to block foreign particles out and prevent lubrication leakage. Our engineering plastic has a strong friction resistance and is less prone to cracking than typical NBR plastics.

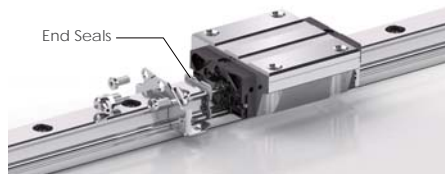

#### Stainless Steel Reinforcement Plate

The reinforcement plate also functions as a scraper for larger particulates like iron fillings, and has no more than 0.3mm clearance between the plate and the rail.

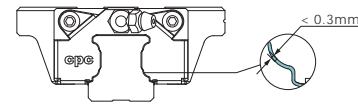

### Average Friction of Block

Below are the tables for the block body and end seal friction levels under greaseless conditions.

Unit : N

Block Type	Friction caused from ball bearing				Bottom Seals + Inner Seals	End Seals ( 2 sides )	
	Preload Class					S-Type Standard	B-Type Low friction
	VC	V0	V1	V2			
15MN/FN	0.30	0.65	0.85	1.10	1.5	2.0	0.5
20MN/FN	0.40	0.75	1.40	1.60	2.0	2.5	1.0
25MN/FN	0.60	0.95	1.30	1.95	2.5	3.0	1.5
30MN/FN	0.55	1.10	2.00	3.10	3.0	5.0	2.0
35MN/FN	0.65	1.25	2.50	3.25	3.0	8.0	3.0
45MN/FN	0.85	2.10	2.80	4.00	4.0	11.0	4.0

Unit : N

Block Type	Friction caused from ball bearing				Bottom Seals + Inner Seals	End Seals ( 2 sides )	
	Preload Class					S-Type Standard	B-Type Low friction
	VC	V0	V1	V2			
15MS/FS	0.30	0.60	0.80	1.00	1.5	2.0	0.5
20MS/FS	0.40	0.70	1.10	1.40	2.0	2.5	1.0
25MS/FS	0.50	0.90	1.20	1.80	2.5	3.0	1.5
30MS/FS	0.50	1.00	1.80	2.30	3.0	5.0	2.0

Unit : N

Block Type	Friction caused from ball bearing				Bottom Seals + Inner Seals	End Seals ( 2 sides )	
	Preload Class					S-Type Standard	B-Type Low friction
	VC	V0	V1	V2			
15ML/FL	0.40	0.70	0.90	1.40	1.5	2.0	0.5
20ML/FL	0.50	0.80	1.60	1.80	2.0	2.5	1.0
25ML/FL	0.70	1.20	1.80	2.00	2.5	3.0	1.5
30ML/FL	0.80	1.40	2.20	2.80	3.0	5.0	2.0
35ML/FL	0.90	1.60	2.70	3.50	3.0	8.0	3.0
45ML/FL	1.00	2.30	3.50	4.55	4.0	11.0	4.0

#### Standard Seals (S)

Our standard seals are in direct contact with the rail surface, giving them increased dustproof and lubrication retention capabilities. **cpc** recommends this class of seal for blocks that operate in environments high in foreign particles, such as sawdust, for long periods of time. S-type seals will have a comparatively higher friction than B-Type seals.

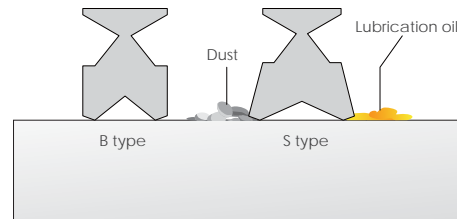

#### Low Friction Seals (B)

Our low-friction seals have slight contact with the rail and are suitable for most environments, with both low friction and a scraper function.

#### Seal type friction comparison

Friction levels will be the highest on new linear rails. But, after short periods of operation, such friction will be reduced to a constant level.

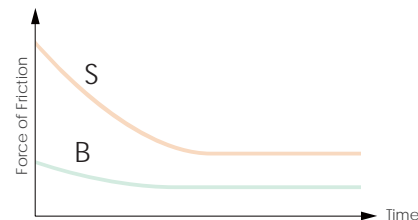

#### Applied example

①. ARC25MN SZ V1N

Block friction =  $1.3+2.5+3 = 6.8\text{N}$

②. HRC30FL BZ V0P

Block friction =  $1.4+3+2 = 6.4\text{N}$

Friction caused from ball bearing

Bottom Seals + Inner Seals

+ End Seals ( 2 sides )

Block friction

## Product Design (Standard)

### Saw wood dust Test

#### Test content

This test uses a total of 4 groups of products (2 rails matched with 2 lubrication methods) which are put on a saw wood dust surface on which a back and forth motion test is performed.

#### Rail

1. Tapped from top rail plus hole plugs (AR)
2. Tapped from bottom rail (ARU)

#### Runner Block

1. Installation of standard contact type seals (S), using grease
2. Installation of lubrication storage Pad and standard contact type seals (SZ), using grease

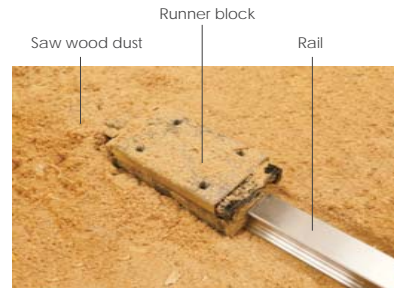

#### Testing conditions

1. Stroke = 600mm
2. Total testing stroke = 30m

#### Test items

1. If saw wood dust enters the inner surface of the runner block
2. If saw wood dust enters the ball bearing runner area

#### Test results



Tapped from bottom (oil)      Tapped from bottom (grease)

Checked Item	If saw wood dust enters inner block surface	If saw wood dust enters ball bearing runner area
Installation status		
ARU Rail SZ Type Runner Block (oil lubrication)	No	No
ARU Rail S Type Runner Block (grease lubrication)	No	No
AR Rail SZ Type Runner Block (oil lubrication)	Yes (belly area)	No
AR Rail S Type Runner Block (grease lubrication)	Yes (belly area)	No

#### Test result

- The tapped from top rail has hole plugs, leading to rail unevenness, allowing some saw wood dust to enter the runner block belly area. The 2 sides of the runner block belly area are completely protected by stainless steel reinforcement plates and end seals, meaning that the ball bearing runner area is fully shielded from saw wood dust.
- The tapped from bottom rail has an even rail surface so that the ball bearing runner area is fully protected from saw wood dust.

### Stainless steel reinforcement plate (Patent)

#### Scraping function on both sides

Using 2 stainless steel reinforcement plates, the L type design allows for screws to be fastened onto the top and bottom of the runner block, reinforcing the rigidity and cladding of its caps.

The clearance between the rail profile with the seal design is below 0.3mm, reinforcing the steel plates while enabling scraper functions.

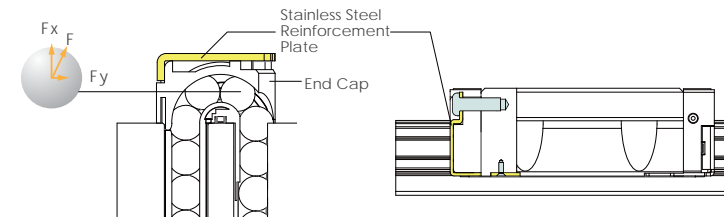

#### Function of high speed operation

Our ARC/HRC/ERC type features stainless steel reinforcement plates and additional bottom latches, increasing its axial force and tolerance capacity to achieve faster operation speeds.

$V_{max} > 10 \text{ m/s}$        $a_{max} > 450 \text{ m/s}^2$

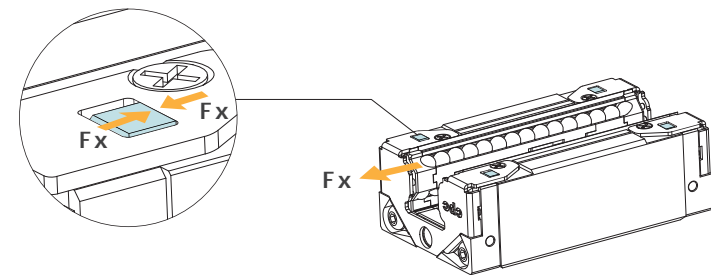

### Multi-Directional Lubrication Nozzles (All-direction Lubrication Nozzles)

Our product features lubrication ports on the top, bottom, and sides, allowing installation of optional grease nipples for relubrication. The top port comes with a O-ring seal to allow easy re-lubrication from the top, and our diverse comprehensive lubrication injection design allows for lubrication in both axis.





## Product Design (Option)

Low noise, superior quality high speed ball chain (Patent)

Ordering code: C

With traditional ball type linear guides, the spinning of balls in different directions leads to a two times faster contact speed. Such high friction greatly reduce the service life of such products. Additionally, the contact point between such balls also produces high pressure and noise levels while increasing the danger of oil film cladding damage.

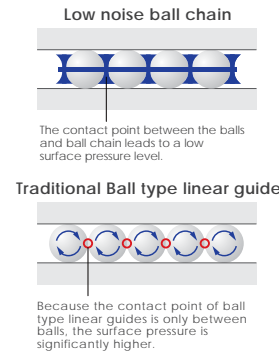

\* The **cpc** ball chain provides a greater contact area between the balls and the ball chain. Because the film cladding will not be damaged easily and due to the lower noise volume, balls can move at a higher speed while product service life can also be extended significantly.

\* The size of the ball chain design block is the same as that of linear guides without ball chains, allowing for same dimensions and use of identical guides.

### Heavy load test

Condition  
 Model : ARC25MN SZC V1H      Dynamic load rating  $C_{100}$  : 24.8kN  
 Velocity : 1m/sec              Stroke : 960mm  
 Load capacities : 7.44kN(0.3C)      Preload : 0.05C

$$\text{Rating Life} \left( \frac{C}{P} \right)^3 \times 100\text{km} = \left( \frac{C}{0.05C + 0.3C} \right)^3 \times 100\text{km} = 2332\text{km}$$

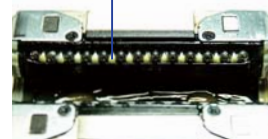
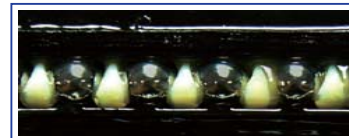

After testing, grease remains without anomalies.

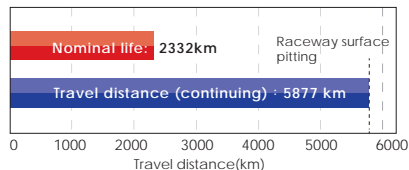

### Smoothness test

Model code : ARC25MNSV1N  
 Velocity : 10 mm/sec

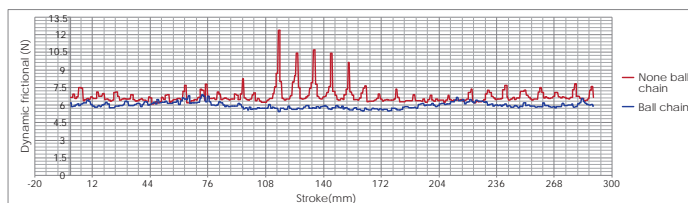

### Load capacity of ball chain

There are three advantages of ARC/HRC/ERC ball chain series as compared with traditional, non-ball chain blocks :

1. The space block in the ball chain can prevent the oil film from rupturing by ball to ball contact and decrease friction induced wear.
2. The retainer block of the ball chain can maintain a reliable oil film layer by continuously applying grease on the moving part.
3. The ball chain provides the important function of leading steel ball motion. For traditional blocks without ball chains, its steel balls are pushed by the rotating back steel balls on the raceway, meaning that the contact angle between the balls and rail is less precise, causing vibration and an increased stress level between balls. In comparison, the balls in our ball chain product are led by the ball chain to ensure a correct fit and accurate contact angles. In this way, our product's ball chain design ensures that it can fit correctly when entering the raceway and that the contact angle will be accurate. This means that our Ball chain design provides for a smooth performance, lower vibration levels and less additional stress levels.

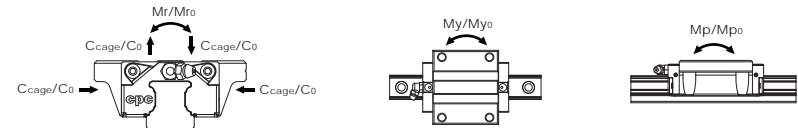

### Dynamic rating load

The table on the right shows the  $C_{cage}$  and  $C_{iso}$  values via different machine type testing. (According to ISO-14728 regulations)

Model Code		$C_{iso}$ (kN)	$C_{cage}$ (kN)	
ARC-MN C	15	9.4	11.8	
	20	15.4	22.3	
	25	22.4	33.6	
	30	31.0	46.5	
	35	43.7	65.6	
HRC-MN C	45	67.6	101.4	
	ARC-ML C	15	12.5	15.6
		20	18.9	27.4
		25	28.5	42.8
		30	38.0	57.0
35		50.6	75.9	
ERC-ML C	45	86.2	129.3	
	ARC-MS C	15	7.1	8.9
20		11.6	16.8	
25		16.8	25.2	
30		21.3	32.0	

### Static rating load & Static torque

The C type block of ARC/HRC/ERC will increase the pitch between balls on the operating profile. Therefore, the static rating load  $C_0$  and the static rating torque  $M_{r0}$ ,  $M_{p0}$  and  $M_{y0}$  values will be decreased.

Model Code		Static rating load(kN)		Static torque(Nm)		
		$C_0$	$M_{r0}$	$M_{p0}$	$M_{y0}$	
ARC-MN C	15	16.2	130	95	95	
	20	25.7	275	200	200	
	25	36.4	465	340	340	
	30	49.6	780	530	530	
	35	70.2	1575	1010	1010	
ERC-MN C	45	102.8	2955	1775	1775	
	ARC-ML C	15	24.3	195	215	215
20		34.3	370	350	350	
25		51.6	655	640	640	
30		66.1	1040	900	900	
35		94.7	1940	1575	1575	
ERC-ML C	45	159.7	4185	3280	3280	
	ARC-MS C	15	10.8	85	45	45
20		17.1	185	85	85	
25		24.3	310	145	145	
30		28.9	455	205	205	

## Product Design

(option)

### Lubrication Design (Ordering Code: Z) (ARC/HRC)

#### Inner oil storage and oil supply system design

Our Inner PU Lubrication Storage Pad design does not increase the length of the runner block and can effectively lubricate all balls. Customers can inject lubrication oil directly through its lubrication holes to ensure a sufficient storage in the PU Lubrication storage pad. This not only enables long term lubrication effects, but also a higher degree of ease at conforming to environment protection needs and lowering maintenance costs. For short stroke movements, this product allows for highly effective lubrication.

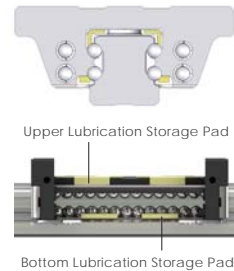

### External NBR Seal with Metal Scraper (Ordering Code: SN) (ARC/HRC/ARR/HRR/LRR)

Available for applications in harsh environments such as in grinding, glass processing, graphite processing and wood-working machinery, providing a highly effective dust and iron scrap proofing solution



### Dimensions and Specifications

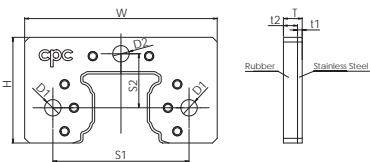

Unit: mm

Model Code	Exterior Dimension				Bore Specification				Screw Specification			
	T	t1	t2	W	H	S1	S2	D1	D2	N1	N2	Ln
15	4	1	3	33	20.3	25	10.2	3.5	3.5	M3x0.35	M3x0.5	9
20	4	1	3	41	22.5	29	11.5	3.5	3.5	M3x0.35	M3x0.5	9
25	5.2	1.2	4	47	26.5	36.5	13.5	3.5	6.5	M3x0.5	M6x0.75	12
30	6	1.5	4.5	58	34.2	42.5	17.5	4.5	6.5	M4x0.5	M6x0.75	12
35	6	1.5	4.5	68	39.3	50	20.5	4.5	6.5	M4x0.5	M6x0.75	12
45	6	1.5	4.5	84	49.6	65	24.9	4.5	10	M4x0.5	PT1/8	15

### Installation Manual

- When installing the external NBR seal, please ensure that the block is on the rail
- Ensure that the rubber part is fitted in the sleeve. If the rubber part has fallen off, set the sleeve to the corresponding bore.
- Overlap the rubber part and metal scraper with the corresponding salient point and bore. The **cpc** logo must be facing outward.
- Slide the external NBR seal into the rail from two sides and closely connect with the block.
- Fasten the screw into the correspondence bore and align the seal with the center of the rail and properly fastened. Do not allow the metal scraper to make contact with the guide rail.

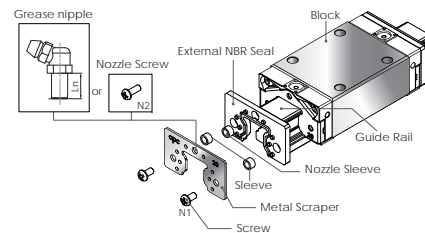

### Metal-Plastic-Cap Patent Design for Standard Rail-Bolt-Hole (With patent) (Ordering Code: MPC)

#### Metal Cap Features Introduction

#### The Most Convenient Metal Cap Used in Industry

- The upper part of the cap is made of stainless steel which can prevent sharp foreign objects from piling up on the bolt-hole and affect the end seal function.
- The lower part of the cap is made of plastic, and can be installed directly on a standard rail without the need for additional bolt-hole slot milling.
- The bolt-hole chamfer for standard rails is C0.2mm. For further dustproof requests, the non-bolt-hole chamfer rail is optional upon ordering. (order code: TR)

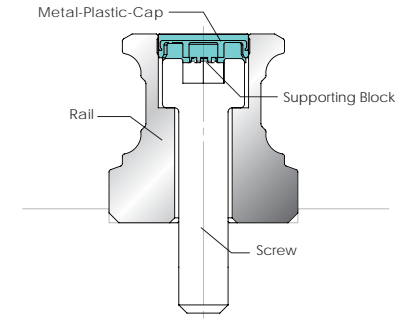
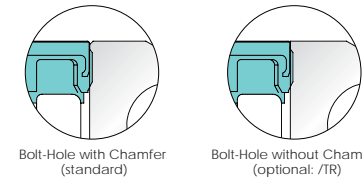

#### Cap can be Smoothly Installed on Bolt-Hole

Bolt-hole cap of conventional linear guides, due to the difficulty of controlling hammering strength, often result in caps being hammered too deep or surface unevenness which leads to the accumulation of dirt or scrap iron. Our **cpc** cap is especially designed with a supporting block to prop up the cap and to fix the screw stably, thus preventing such unnecessary sinking.

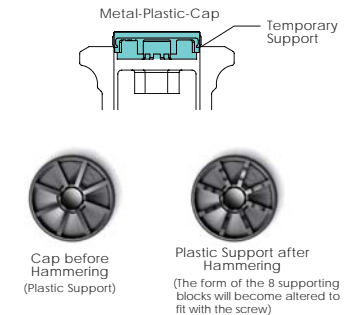

#### Dimensions and Specifications

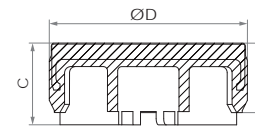

Model Code	Screw	External Diameter D	Cup Height H	Block Height C	Rail
A4	M4	7.7	1.7	2.0	AR15, WRC21/15, WRC27/20
A5	M5	9.7	3.4	4.0	AR20
A6	M6	11.3	2.9	3.5	AR25
A8	M8	14.3	3.9	4.5	AR30, AR35
A12	M12	20.4	5.0	5.6	AR45
A8-R	M8	14.3	8.0	9.5	ARR35

## Installation Notice

### Dimension of reference edge

To ensure that the linear guide is precisely assembled with the machine table, **cpc** devices have a recess installed in the reference edge corner. The corner of the machine table must be smaller than the chamfer of the linear guide to avoid interference. To consult on chamfer sizes and shoulder heights, please refer to the table below.

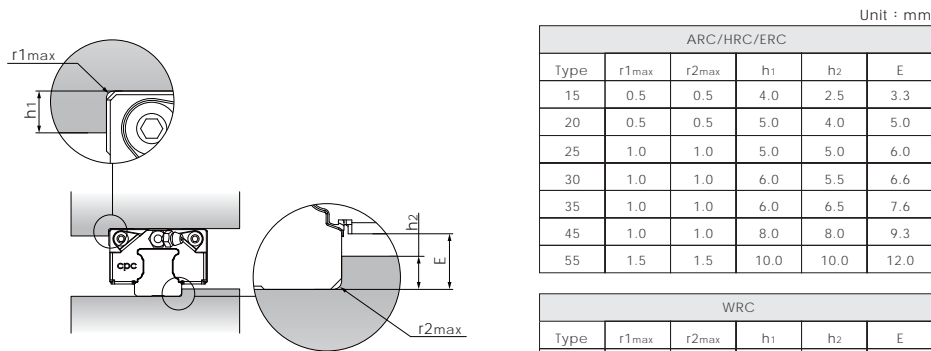

### Rail Joint

The standard length of our large rails is 4 meters. If longer rails are required, **cpc** can provide a joint rail solution for which the joint number will be marked on the rail.

- As shown in figure A, please follow the joint number to assemble.
- For more than two units in each axis, to avoid accuracy effects from multiple blocks passing through the same connection point, we advise to use the connection points separately as shown on figure B.
- Please use the slide as a connection point to tighten the slide before tightening the torques to fasten the screws from inside to outside.

Figure A



Figure B

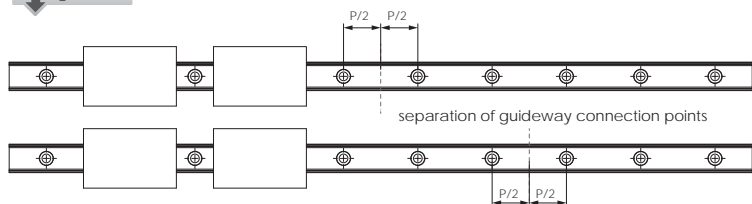

## Technical information

### Screw tightening torque (Nm)

Screw grade 12.9 Alloy Steel Screw	Steel	Cast Iron	Non Iron Metal
M3	2.0	1.3	1.0
M4	4.1	2.7	2.1
M5	8.8	5.9	4.4
M6	13.7	9.2	6.9
M8	30	20	15
M10	68	45	33
M12	118	78	59
M14	157	105	78
M16	196	131	98

### Preload and clearance

The ARC/HRC/ERC linear guides provide 4 different preload classes VC, V0, V1, V2.

		ARC/WRC								Application
Class	Description	Preload Value	Clearance (μm)							
			15	20	25	30	35	45		
			WRC21/15	WRC27/20						
VC	Clearance	0	+5~+0	+5~+0	+5~+0	+5~+0	+5~+0	+5~+0	+5~+0	Smooth motion, low friction
V0	Light Preload	0.02C	+0~-4	+0~-5	+0~-6	+0~-7	+0~-8	+0~-10	+0~-12	For precision situations, smooth motion
V1	Medium Preload	0.05C	-4~-10	-5~-12	-6~-15	-7~-18	-8~-20	-10~-24	-12~-28	High stiffness, precision, high load situations
V2	Heavy Preload	0.08C	-10~-16	-12~-18	-15~-23	-18~-27	-20~-31	-24~-36	-28~-45	Super high stiffness, precision and load capacity

		HRC/ERC								Application
Class	Description	Preload Value	Clearance (μm)							
			15	20	25	30	35	45		
VC	Clearance	0	+5~+0	+5~+0	+5~+0	+5~+0	+5~+0	+5~+0	+5~+0	Smooth motion, low friction
V0	Light Preload	0.02C	+0~-4	+0~-5	+0~-6	+0~-7	+0~-8	+0~-10	+0~-12	For precision situations, smooth motion
V1	Medium Preload	0.08C	-4~-12	-5~-14	-6~-16	-7~-19	-8~-22	-10~-25	-12~-29	High stiffness, precision, high load situations
V2	Heavy Preload	0.13C	-11~-19	-14~-23	-16~-26	-19~-31	-22~-35	-25~-40	-29~-46	Super high stiffness, precision and load capacity



## Technical information

### Accuracy

The ARC/HRC/ERC/WRC linear guides provide 5 different grades of precision : N, H, P, SP, and UP. Engineers can choose different grades depending on the machine applications.

### Accuracy

		Table of accuracy					
Accuracy grades (μm)			UP	SP	P	H	N
	Tolerance of dimension height H	H	±5	±10	±20	±40	±100
	Variation of height for different runner blocks on the same position of Rail	ΔH	3	5	7	15	30
	Tolerance of dimension width W <sub>2</sub>	W <sub>2</sub>	±5	±7	±10	±20	±40
	Variation of width for different runner blocks on the same position of Rail	ΔW <sub>2</sub>	3	5	7	15	30

### Runner block relative to linear guide, datum plane parallel motion precision

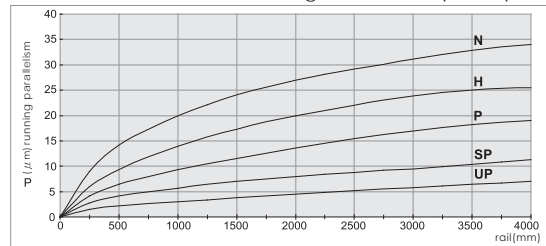

### Application

class	Movement, Conveyance	Manufacturing Equipment	High Precision Manufacturing Equipment	Measuring Equipment
N	●	●		
H	●	●	●	
P		●	●	●
SP			●	●
UP				●
Examples	1. Conveyance system 2. Industrial robots 3. Office Machinery	1. Woodworking machine 2. Punching press 3. Injection Molding machine	1. Lathe/milling machine/ grinding machine 2. Electrical discharge machining (EDM) 3. CNC machining center	1. Three dimensional measuring instrument 2. Detection mirror/head shaft 3. X-Y Table

## Ordering information

Model code																
ARC	U	15	M	N	B	2	Z	C	V1	P	-1480L	-20	-20	II	/J	
													Customization code			
													Number of rails on the same moving axis			
													End hole pitch (mm)			
													Starting hole pitch (mm)			
													Rail length (mm)			
													Accuracy grade : UP, SP, P, H, N			
													Preload class : VC, V0, V1, V2			
													C: with ball chain (Available for size 15,20,25,30,35 and 45)			
													Z: with lubrication storage pad (Available for size 15,20,25,30,35 and 45)			
													Block quantity			
													Seal type : B: Low friction S: Standard			
													Block length : L: long N: standard S: short			
													Block width : M: standard F: flanged			
													Block type : 15, 20, 25, 30, 35, 45, 55			
													U: rail (tapped from the bottom)			
													Product type : ARC: automation series HRC/ERC: heavy load series			

### Customization code(The meaning of suffix characters)

J : slide rail connection	R : special process for rail	SG : installation of side grease holes and set screws
G : customer designated lubricant	VD : customized designated preload pressure value	PC : with plastic caps for counter holes on the rail
I : with Inspection report	OA : block install with grease nipple by <b>cpc</b> (Please contact <b>cpc</b> for direction of grease nipple installation)	MPC : with Metal-Plastic Caps for rail mounting holes.
S : special straightness requirements for rail	DE : reference edges of block and rail on opposite sides	TR : bolt-Hole without chamfer
B : special processing for block		
BL : with extension and contraction support layer.		
SN : external NBR seal with metal scraper		
BR : black chrome coating treatment on the rail	CR : clear chrome coating treatment on the rail	RR : raydent coating treatment on the rail
BB : black chrome coating treatment on the block	CB : clear chrome coating treatment on the block	RB : raydent coating treatment on the block
BRB : black chrome coating treatment on the block and rail	CRB : clear chrome coating treatment on the block and rail	RRB : raydent coating treatment on the block and rail
SB : with stainless steel ball bearings	NR : nickel coating treatment on the rail	NB : nickel coating treatment on the block
NRB : nickel coating treatment on the block and rail		

Note: If there is a need for further customization or other special requirements, please contact **cpc** for more information.

## Dimensions Table

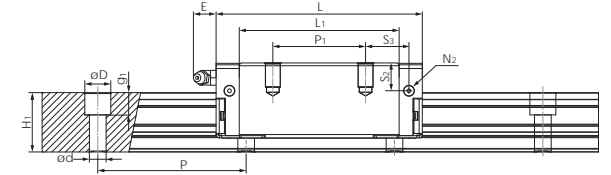
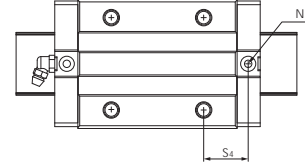
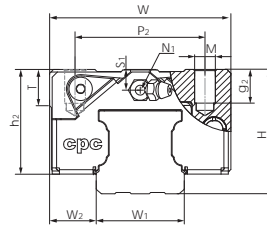

### ARC MS Series

Model Code	Mounting Dimensions		Rail Dimensions(mm)				Block Dimensions(mm)														Load Capacities (KN)				Static Moment (Nm)			Weight		Model Code		
	H	W <sub>2</sub>	W <sub>1</sub>	H <sub>1</sub>	P	D x d x G <sub>1</sub>	W	L	L <sub>1</sub>	h <sub>2</sub>	P <sub>1</sub>	P <sub>2</sub>	P <sub>3</sub>	M x G <sub>2</sub>	M <sub>1</sub>	T	N <sub>1</sub>	N <sub>2</sub>	N <sub>3</sub>	E	S <sub>1</sub>	S <sub>2</sub>	S <sub>3</sub>	S <sub>4</sub>	C	C <sub>0</sub>	M <sub>r0</sub>	M <sub>p0</sub>	M <sub>y0</sub>		Block(g)	Rail(g/m)
ARC 15 MS	24	9.5	15	15	60	7.5x4.5x5.3	34	41.2	26	20.7	-	26	-	M4x7	-	6	M3x6.5	M3x6	P3	3.5	4.5	7.5	15.6	16.7	7.7	12.1	100	50	50	106	1290	ARC 15 MS
ARC 20 MS	28	11	20	20	60	9.5x6x8.5	42	49.2	32.2	23	-	32	-	M5x7	-	8	M3x7.5	M3x5.5	P4	10	4	7.4	19.1	19.8	12.5	19.3	205	100	100	170	2280	ARC 20 MS
ARC 25 MS	33	12.5	23	23	60	11x7x9	48	57.4	38.4	27	-	35	-	M6x9	-	8	M6x7.5	M3x6.5	P4	12	5	9.3	22.2	23.2	18.2	27.3	350	160	160	300	3020	ARC 25 MS
ARC 30 MS	42	16	28	27	80	14x9x12	60	68	44	35.2	-	40	-	M8x10	-	12	M6x8.5	M6x5	P5	12	7.5	12	27	26.7	23.3	33.1	520	230	230	560	4380	ARC 30 MS

### ARC MN Series

ARC 15 MN	24	9.5	15	15	60	7.5x4.5x5.3	34	55.5	40.3	20.7	26	26	-	M4x7	-	6	M3x6.5	M3x6	P3	3.5	4.5	7.5	9.8	10.9	9.9	17.5	140	105	105	158	1290	ARC 15 MN
ARC 20 MN	28	11	20	20	60	9.5x6x8.5	42	69	52	23	32	32	-	M5x7	-	8	M3x7.5	M3x5.5	P4	10	4	7.4	13	13.7	17.1	30.0	325	230	230	266	2280	ARC 20 MN
ARC 25 MN	33	12.5	23	23	60	11x7x9	48	81.2	62.2	27	35	35	-	M6x9	-	8	M6x7.5	M3x6.5	P4	12	5	9.3	16.6	17.6	24.8	42.5	540	385	385	420	3020	ARC 25 MN
ARC 30 MN	42	16	28	27	80	14x9x12	60	95.5	71.5	35.2	40	40	-	M8x10	-	12	M6x8.5	M6x5	P5	12	7.5	12	20.8	20.5	32.8	53.7	845	565	565	800	4380	ARC 30 MN
ARC 35 MN	48	18	34	32	80	14x9x12	70	111.2	86.2	40.4	50	50	-	M8x13	-	14	M6x10	M6x7	P5	12	8	15	23.4	24.1	45.9	82.9	1700	1080	1080	1120	6790	ARC 35 MN
ARC 45 MN	60	20.5	45	39	105	20x14x17	86	135.5	102.5	50.7	60	60	-	M10x17	-	14	PT1/8x12.5	M6x10.5	P5	14	11.1	18.1	27.3	27.2	71.3	122.1	3200	1910	1910	2120	10530	ARC 45 MN
ARC 55 MN	70	23.5	53	45.7	120	24x16x20	100	168.5	126.5	58	75	75	-	M12x20	-	16	M6x10	M6x13	P5	12	13.5	23.5	34.8	33.8	128	186	4949	3278	3278	4200	14000	ARC 55 MN

### ARC ML Series

ARC 15 ML	24	9.5	15	15	60	7.5x4.5x5.3	34	76.2	61	20.7	34	26	-	M4x7	-	6	M3x6.5	M3x6	P3	3.5	4.5	7.5	16.1	17.2	13.4	26.9	215	235	235	240	1290	ARC 15 ML
ARC 20 ML	28	11	20	20	60	9.5x6x8.5	42	87.2	70.2	23	45	32	-	M5x7	-	8	M3x7.5	M3x5.5	P4	10	4	7.4	15.6	16.3	20.4	38.5	415	390	390	330	2280	ARC 20 ML
ARC 30 ML	42	16	28	27	80	14x9x12	60	118	94	35.2	60	40	-	M8x10	-	12	M6x8.5	M6x5	P5	12	8.7	12	21.7	21.7	39.6	70.2	1105	950	950	1138	4380	ARC 30 ML
ARC 35 ML	48	18	34	32	80	14x9x12	70	136.6	111.6	40.4	72	50	-	M8x13	-	14	M6x10	M6x7	P5	12	8	15	25.1	25.8	54.7	106.5	2185	1755	1755	1536	6790	ARC 35 ML
ARC 45 ML	60	20.5	45	39	105	20x14x17	86	171.5	138.5	50.7	80	60	-	M10x17	-	14	PT1/8x12.5	M6x10.5	P5	14	11.1	18.1	35	35	89.5	169.1	4430	3460	3460	3160	10530	ARC 45 ML
ARC 55 ML	70	23.5	53	45.7	120	24x16x20	100	202	160	58	95	75	-	M12x20	-	16	M6x10	M6x13	P5	12	13.5	23.5	41.5	40.5	147	226	6472	5284	5284	5083	14000	ARC 55 ML

1. The load capacities is for full-ball type (without ball chain)

2. N<sub>2</sub> = Injecting holes

3. N<sub>3</sub> = O-ring size for lubrication from above

4. N<sub>2</sub>, N<sub>3</sub> will be sealed before shipment, please open it when first using the product.

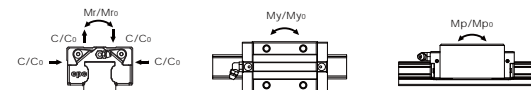

The above rating load capacities and static moments are calculated according to the ISO14728 standard. The rating life for basic dynamic load ratings is defined as the total 100km travel distance for 90% of a group of identical linear guides, under the same conditions and free from any material damage caused by rolling fatigue. If a standard of 50km travel distance is applied to measure the average product lifespan, the above basic dynamic load rating C should be multiplied by 1.26 for an accurate conversion.

## Dimensions Table

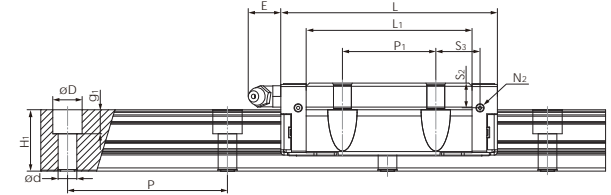
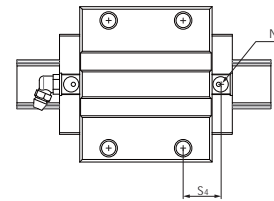
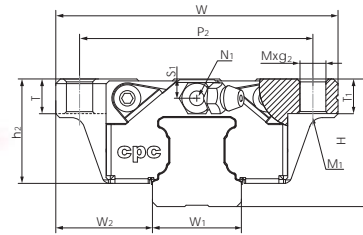

### ARC FS Series

Model Code	Mounting Dimensions		Rail Dimensions(mm)				Block Dimensions(mm)											Block Dimensions(mm)					Load Capacities (KN)		Static Moment (Nm)			Weight		Model Code			
	H	W <sub>2</sub>	W <sub>1</sub>	H <sub>1</sub>	P	D <sub>x</sub> d <sub>x</sub> g <sub>1</sub>	W	L	L <sub>1</sub>	h <sub>2</sub>	P <sub>1</sub>	P <sub>2</sub>	P <sub>3</sub>	M x g <sub>2</sub>	M <sub>1</sub>	T	T <sub>1</sub>	N <sub>1</sub>	N <sub>2</sub>	N <sub>3</sub>	E	S <sub>1</sub>	S <sub>2</sub>	S <sub>3</sub>	S <sub>4</sub>	C	C <sub>0</sub>	M <sub>r0</sub>	M <sub>p0</sub>		M <sub>y0</sub>	Block(g)	Rail(g/m)
ARC 15 FS	24	18.5	15	15	60	7.5x4.5x5.3	52	41.2	26	20.7	-	41	-	M5x7	M4	7	7	M3x6.5	M3x6	P3	3.5	4.5	7.5	15.6	16.7	7.7	12.1	100	50	50	132	1290	ARC 15 FS
ARC 20 FS	28	19.5	20	20	60	9.5x6x8.5	59	49.2	32.2	23	-	49	-	M6x10	M5	10	10	M3x7.5	M3x5.5	P4	10	4	7.4	19.1	19.8	12.5	19.3	205	100	100	210	2280	ARC 20 FS
ARC 25 FS	33	25	23	23	60	11x7x9	73	57.4	38.4	27	-	60	-	M8x12	M6	12	12	M6x7.5	M3x6.5	P4	12	5	9.3	22.2	23.2	18.2	27.3	350	160	160	345	3020	ARC 25 FS
ARC 30 FS	42	31	28	27	80	14x9x12	90	68	44	35.2	-	72	-	M10x12	M8	12	12	M6x8.5	M6x5	P5	12	7.5	12	27	26.8	23.3	33.1	520	230	230	750	4380	ARC 30 FS

### ARC FN Series

ARC 15 FN	24	18.5	15	15	60	7.5x4.5x5.3	52	55.5	40.3	20.7	26	41	-	M5x7	M4	7	7	M3x6.5	M3x6	P3	3.5	4.5	7.5	8.9	10.9	9.9	17.5	140	105	105	200	1290	ARC 15 FN
ARC 20 FN	28	19.5	20	20	60	9.5x6x8.5	59	69	52	23	32	49	-	M6x10	M5	10	10	M3x7.5	M3x5.5	P4	10	4	7.4	13	13.7	17.1	30.0	325	230	230	336	2280	ARC 20 FN
ARC 25 FN	33	25	23	23	60	11x7x9	73	81.2	62.2	27	35	60	-	M8x12	M6	12	12	M6x7.5	M3x6.5	P4	12	5	9.3	16.6	17.6	24.8	42.5	540	385	385	524	3020	ARC 25 FN
ARC 30 FN	42	31	28	27	80	14x9x12	90	95.5	71.5	35.2	40	72	-	M10x12	M8	12	12	M6x8.5	M6x5	P5	12	7.5	12	20.8	20.5	32.8	53.7	845	565	565	1200	4380	ARC 30 FN
ARC 35 FN	48	33	34	32	80	14x9x12	100	111.2	86.2	40.4	50	82	-	M10x12	M8	12	12	M6x10	M6x7	P5	12	8	15	23.4	24.1	45.9	82.9	1700	1080	1080	1580	6790	ARC 35 FN

1. The load capacities is for full-ball type (without ball chain)  
 3. N<sub>3</sub> = O-ring size for lubrication from above

2. N<sub>2</sub> = Injecting holes  
 4. N<sub>2</sub>, N<sub>3</sub> will be sealed before shipment, please open it when first using the product.

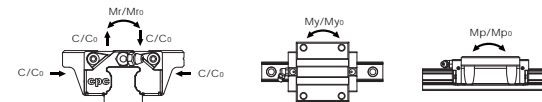

The above rating load capacities and static moments are calculated according to the ISO14728 standard. The rating life for basic dynamic load ratings is defined as the total 100km travel distance for 90% of a group of identical linear guides, under the same conditions and free from any material damage caused by rolling fatigue. If a standard of 50km travel distance is applied to measure the average product lifespan, the above basic dynamic load rating C should be multiplied by 1.26 for an accurate conversion.

## Dimensions Table

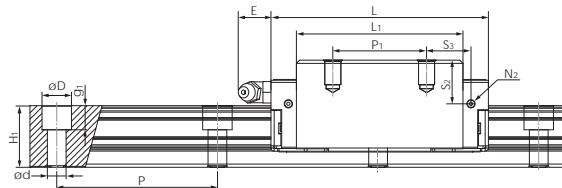
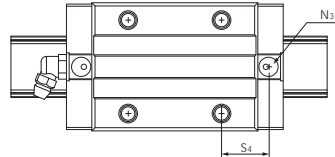
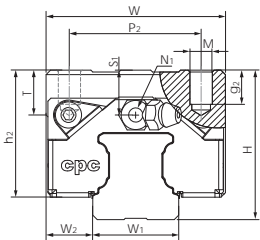

### HRC MN Series

Model Code	Mounting Dimensions		Rail Dimensions(mm)				Block Dimensions(mm)								Block Dimensions(mm)								Load Capacities (KN)		Static Moment (Nm)			Weight		Model Code		
	H	W2	W1	H1	P	Dxdg1	W	L	L1	h2	P1	P2	P3	Mxg2	M1	T	N1	N2	N3	E	S1	S2	S3	S4	C	C0	Mr0	Mp0	My0		Block(g)	Rail(g/m)
HRC 15 MN	28	9.5	15	15	60	7.5x4.5x5.3	34	55.5	40.3	24.7	26	26	-	M4x7	-	6	M3x6.5	M3x6	P3	3.5	8.5	11.5	9.8	10.9	9.9	17.5	140	105	105	200	1290	HRC 15 MN
HRC 20 MN	30	12	20	20	60	9.5x6x8.5	44	69	52	25	36	32	-	M5x8.5	-	8	M3x7.5	M3x5.5	P4	10	6	9.4	11	11.7	17.1	30.0	325	230	230	318	2280	HRC 20 MN
HRC 25 MN	40	12.5	23	23	60	11x7x9	48	81.2	62.2	34	35	35	-	M6x9	-	12	M6x7.5	M3x6.5	P4	12	12	16.3	16.6	17.6	24.8	42.5	540	385	385	578	3020	HRC 25 MN
HRC 30 MN	45	16	28	27	80	14x9x12	60	95.5	71.5	38.4	40	40	-	M8x12	-	12	M6x8.5	M6x5	P5	12	10.5	15	20.8	20.5	32.8	53.7	845	565	565	896	4380	HRC 30 MN
HRC 35 MN	55	18	34	32	80	14x9x12	70	111.2	86.2	47.4	50	50	-	M8x13	-	14	M6x10	M6x7	P5	12	15	22	23.4	24.1	45.9	82.9	1700	1080	1080	1430	6790	HRC 35 MN
HRC 45 MN	70	20.5	45	39	105	20x14x17	86	135.5	102.5	60.7	60	60	-	M10x20	-	14	PT1/8x12.5	M6x10.5	P5	14	21.1	28.1	27.3	27.3	71.3	122.1	3200	1910	1910	2794	10530	HRC 45 MN
HRC 55 MN	80	23.5	53	45.7	120	24x16x20	100	168.5	126.5	68	75	75	-	M12x25	-	16	M6x10	M6x13	P5	12	23.5	33.5	34.8	33.8	128	186	4949	3278	3278	5110	14000	HRC 55 MN

### HRC ML Series

Model Code	H	W2	W1	H1	P	Dxdg1	W	L	L1	h2	P1	P2	P3	Mxg2	M1	T	N1	N2	N3	E	S1	S2	S3	S4	C	C0	Mr0	Mp0	My0	Block(g)	Rail(g/m)	Model Code
HRC 15 ML	28	9.5	15	15	60	7.5x4.5x5.3	34	76.2	61	24.7	26	26	-	M4x7	-	6	M3x6.5	M3x6	P3	3.5	8.5	11.5	20.1	21.2	13.4	26.9	215	235	235	300	1290	HRC 15 ML
HRC 20 ML	30	12	20	20	60	9.5x6x8.5	44	87.2	70.2	25	50	32	-	M5x8.5	-	8	M3x7.5	M3x5.5	P4	10	6	9.4	13.1	13.8	20.4	38.5	415	390	390	400	2280	HRC 20 ML
HRC 25 ML	40	12.5	23	23	60	11x7x9	48	105	86	34	50	35	-	M6x9	-	12	M6x7.5	M3x6.5	P4	12	12	16.3	21	22	30.7	57.7	735	710	710	685	3020	HRC 25 ML
HRC 30 ML	45	16	28	27	80	14x9x12	60	118	94	38.4	60	40	-	M8x12	-	12	M6x8.5	M6x5	P5	12	10.5	15	21.7	21.8	39.6	70.2	1105	950	950	1150	4380	HRC 30 ML
HRC 35 ML	55	18	34	32	80	14x9x12	70	136.6	111.6	47.4	72	50	-	M8x13	-	14	M6x10	M6x7	P5	12	15	22	25.1	25.8	54.7	106.5	2185	1755	1755	1953	6790	HRC 35 ML
HRC 45 ML	70	20.5	45	39	105	20x14x17	86	171.5	138.5	60.7	80	60	-	M10x20	-	14	PT1/8x12.5	M6x10.5	P5	14	21.1	28.1	35	35	89.5	169.1	4430	3460	3460	4060	10530	HRC 45 ML
HRC 55 ML	80	23.5	53	45.7	120	24x16x20	100	202	160	68	95	75	-	M12x25	-	16	M6x10	M6x13	P5	12	23.5	33.5	41.5	40.5	147	226	6472	5284	5284	6243	14000	HRC 55 ML

### ERC Series

ERC 25 MS	36	12.5	23	23	60	11x7x9	48	57.4	38.4	30	-	35	-	M6x9	-	8	M6x7.5	M3x6.5	P4	12	8	12.3	22.2	23.2	18.2	27.3	350	160	160	315	3020	ERC 25 MS
ERC 25 MN	36	12.5	23	23	60	11x7x9	48	81.2	62.2	30	35	35	-	M6x9	-	8	M6x7.5	M3x6.5	P4	12	8	12.3	16.6	17.6	24.8	42.5	540	385	385	470	3020	ERC 25 MN
ERC 25 ML	36	12.5	23	23	60	11x7x9	48	105	86	30	50	35	-	M6x9	-	8	M6x7.5	M3x6.5	P4	12	8	12.3	21	22	30.7	57.7	735	710	710	610	3020	ERC 25 ML

1. The load capacities is for full-ball type (without ball chain)  
3. N3 = O-ring size for lubrication from above

2. N2 = Injecting holes  
4. N2, N3 will be sealed before shipment, please open it when first using the product.

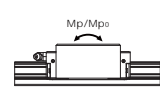
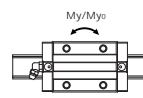
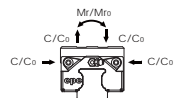

The above rating load capacities and static moments are calculated according to the ISO14728 standard. The rating life for basic dynamic load ratings is defined as the total 100km travel distance for 90% of a group of identical linear guides, under the same conditions and free from any material damage caused by rolling fatigue. If a standard of 50km travel distance is applied to measure the average product lifespan, the above basic dynamic load rating C should be multiplied by 1.26 for an accurate conversion.

## Dimensions Table

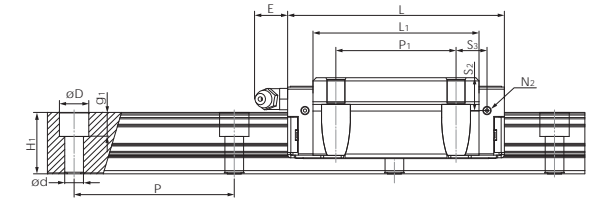
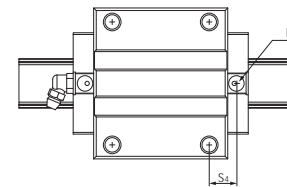
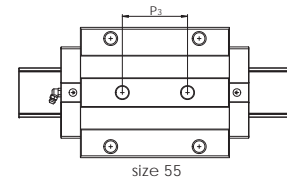
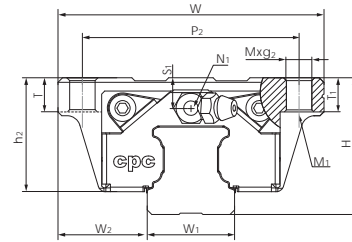

Model Code	Mounting Dimensions		Rail Dimensions(mm)				Block Dimensions(mm)											Block Dimensions(mm)						Load Capacities (KN)		Static Moment (Nm)			Weight		Model Code		
	H	W <sub>2</sub>	W <sub>1</sub>	H <sub>1</sub>	P	Dxdg <sub>1</sub>	W	L	L <sub>1</sub>	h <sub>2</sub>	P <sub>1</sub>	P <sub>2</sub>	P <sub>3</sub>	MxG <sub>2</sub>	M <sub>1</sub>	T	T <sub>1</sub>	N <sub>1</sub>	N <sub>2</sub>	N <sub>3</sub>	E	S <sub>1</sub>	S <sub>2</sub>	S <sub>3</sub>	S <sub>4</sub>	C	C <sub>0</sub>	M <sub>r0</sub>	M <sub>p0</sub>	M <sub>y0</sub>		Block(g)	Rail(g/m)
HRC 15 FN	24	16	15	15	60	7.5x4.5x5.3	47	55.5	40.3	20.7	30	38	-	M5x7	M4	7	7	M3x6.5	M3x6	P3	3.5	4.5	7.5	7.8	8.9	9.9	17.5	140	105	105	190	1290	HRC 15 FN
HRC 20 FN	30	21.5	20	20	60	9.5x6x8.5	63	69	52	25	40	53	-	M6x10	M5	10	10	M3x7.5	M3x5.5	P4	10	6	9.4	9	9.7	17.1	30.0	325	230	230	396	2280	HRC 20 FN
HRC 25 FN	36	23.5	23	23	60	11x7x9	70	81.2	62.2	30	45	57	-	M8x12	M6	12	12	M6x7.5	M3x6.5	P4	12	8	12.3	11.6	12.6	24.8	42.5	540	385	385	626	3020	HRC 25 FN
HRC 30 FN	42	31	28	27	80	14x9x12	90	95.5	71.5	35.2	52	72	-	M10x12	M8	12	12	M6x8.5	M6x5	P5	12	7.5	12	14.8	14.5	32.8	53.7	845	565	565	1110	4380	HRC 30 FN
HRC 35 FN	48	33	34	32	80	14x9x12	100	111.2	86.2	40.4	62	82	-	M10x12	M8	12	12	M6x10	M6x7	P5	12	8	15	17.4	18.1	45.9	82.9	1700	1080	1080	1550	6790	HRC 35 FN
HRC 45 FN	60	37.5	45	39	105	20x14x17	120	135.5	102.5	50.7	80	100	-	M12x15	M10	15	15	PT1/8x12.5	M6x10.5	P5	14	11.1	18.1	17.3	17.3	71.3	122.1	3200	1910	1910	2747	10530	HRC 45 FN
HRC 55 FN	70	43.5	53	45.7	120	24x16x20	140	168.5	126.5	58	95	116	70	M14x18	M12	18	18	M6x10	M6x13	P5	12	13.5	23.5	24.8	23.8	128	186	4949	3278	3278	5440	14000	HRC 55 FN

HRC 20 FL	30	21.5	20	20	60	9.5x6x8.5	63	87.2	70.2	25	40	53	-	M6x10	M5	10	10	M3x7.5	M3x5.5	P4	10	6	9.4	18.1	18.8	20.4	38.5	415	390	390	504	2280	HRC 20 FL
HRC 25 FL	36	23.5	23	23	60	11x7x9	70	105	86	30	45	57	-	M8x12	M6	12	12	M6x7.5	M3x6.5	P4	12	8	12.3	23.5	24.5	30.7	57.5	735	710	710	870	3020	HRC 25 FL
HRC 30 FL	42	31	28	27	80	14x9x12	90	118	94	35.2	52	72	-	M10x12	M8	12	12	M6x8.5	M6x5	P5	12	7.5	12	25.7	25.8	39.6	70.2	1105	950	950	1385	4380	HRC 30 FL
HRC 35 FL	48	33	34	32	80	14x9x12	100	136.6	111.6	40.4	62	82	-	M10x12	M8	12	12	M6x10	M6x7	P5	12	8	15	30.1	30.8	54.7	106.5	2185	1755	1755	2000	6790	HRC 35 FL
HRC 45 FL	60	37.5	45	39	105	20x14x17	120	171.5	138.5	50.7	80	100	-	M12x15	M10	15	15	PT1/8x12.5	M6x10.5	P5	14	11.1	18.1	35	35	89.5	169.1	4430	3460	3460	4280	10530	HRC 45 FL
HRC 55 FL	70	43.5	53	45.7	120	24x16x20	140	202	160	58	95	116	70	M14x18	M12	18	18	M6x10	M6x13	P5	12	13.5	23.5	41.5	40.5	147	226	6472	5284	5284	6963	14000	HRC 55 FL

1. The load capacities is for full-ball type (without ball chain)  
 3. N<sub>3</sub> = O-ring size for lubrication from above

2. N<sub>2</sub> = Injecting holes  
 4. N<sub>2</sub> N<sub>3</sub> will be sealed before shipment, please open it when first using the product.

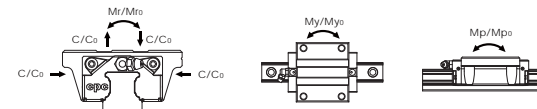

The above rating load capacities and static moments are calculated according to the ISO14728 standard. The rating life for basic dynamic load ratings is defined as the total 100km travel distance for 90% of a group of identical linear guides, under the same conditions and free from any material damage caused by rolling fatigue. If a standard of 50km travel distance is applied to measure the average product lifespan, the above basic dynamic load rating C should be multiplied by 1.26 for an accurate conversion.



## Product Overview

### AR/HR/ER Lightweight Linear Guide Product Characteristics

The **cpc** lightweight Ball Type Linear Guide Series adopts a unique O-type arrangement and four row ball circulation design, featuring high load capacities and stiffness. The contact angle between the rail and the ball is 45 degrees and enables an equal load capacity in all 4 directions.

Among the AR/HR/ER Lightweight Linear Guides, two of the four circulation channels are positioned within the plastic accessories, reducing the block weight by 10-20%.

Our Stainless steel reinforcement plate has scraper functions while our L design fastens the screws onto the top and bottom of the runner block, reinforcing the rigidity of both the end caps and cladding; thereby further enabling the high speed movement of products. Our AR/HR/ER Lightweight Linear Guide also provides preload classes of VC and V0 etc.

This is to enhance the dimension tolerance and to further satisfy the convenience for our customers processed component requirements and to further reduce the cost for such manufacturing work.

- High velocity tolerance
- Four directional load capacity.
- Utilizing the same rail as ARC/HRC/ERC
- Lightweight steel block reflow hole design
- Processed accessories match dimension tolerance
- vertical (downward) and reverse (upward) bolting track rails available.

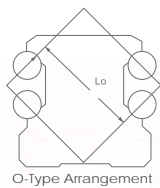

All-directional lubrication nozzles and replenishment system

Standard equipped stainless steel reinforcement plate and scraper function

Eco lubrication design: Eco System lowers long term maintenance needs with minimal lubrication

- Available for special surface treatment
- Excellent dynamic performance: Reach  $V_{max} > 5m/s$     Reach  $a_{max} > 300m/s^2$
- Dust protection of double wipe blade design in the end seal; equipped as either standard or extra reinforcement type

## Technical information

### Accuracy

	Table of accuracy		
	Accuracy grades ( $\mu m$ )	H	N
Admissible tolerance for dimension height H	H	$\pm 40$	$\pm 100$
Variation of height for different runner blocks on the same rail position	$\Delta H$	15	30
Tolerance of dimension width $W_2$	$W_2$	$\pm 20$	$\pm 40$
Variation of width for different runner blocks on the same rail position	$\Delta W_2$	15	30

For parallel datum plane motion accuracy of runner block in contrast to the linear guide, please refer to P13

### Preload and clearance

AR/HR/ER						
Class	Description	Preload Value	Clearance ( $\mu m$ )			Application
			15	20	25	
VC	Clearance	0	+10~+2	+10~+2	+11~+3	Extremely Smooth motion, low friction
V0	Light preload	0.02C	+2~-4	+2~-5	+3~-6	For precision applications, smooth motion

## Ordering information

AR	U	15	M	N	B	2	Z	V0	H	-1480L	-20	-20	II	/J	
Customization code (Please refer to P14)															
Number of rails on the same moving axis															
End hole pitch (mm)															
Starting hole pitch (mm)															
Rail length (mm)															
Accuracy grade : H, N															
Preload class : VC, V0															
Z: with lubrication storage pad															
Block quantity															
Seal type : B: Low friction    S: Standard															
Block length : L: long    N: standard    S: short															
Block width : M: standard    F: flanged															
Block type : 15, 20, 25															
U: rail (tapped from the bottom)															
Product type : AR: automation series    HR/ER: heavy load series															

## Dimensions Table

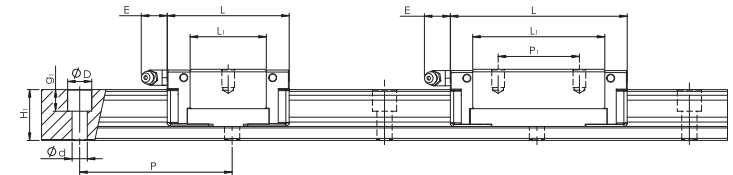
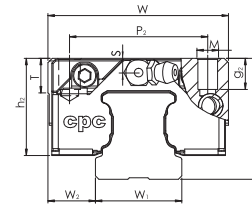
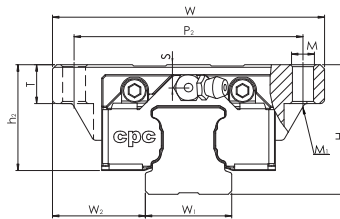

### AR Series

Model Code	Mounting Dimensions		Rail Dimensions(mm)			Block Dimensions(mm)							Block Dimensions(mm)				Load Capacities (KN)			Static Moment (Nm)			Weight		Model Code	
	H	W <sub>2</sub>	W <sub>1</sub>	H <sub>1</sub>	P	D <sub>x</sub> d <sub>x</sub> g <sub>1</sub>	W	L	L <sub>1</sub>	h <sub>2</sub>	P <sub>1</sub>	P <sub>2</sub>	E	M x g <sub>2</sub>	M <sub>1</sub>	S	T	C <sub>ISO</sub>		C <sub>0</sub>	Mr <sub>0</sub>	Mp <sub>0</sub>	My <sub>0</sub>	Block(g)		Rail(g/m)
																		100km	50km							
AR 15 FS	24	18.5	15	15	60	7.5x4.5x5.3	52	40.8	24.2	20.1	-	41	4.5	M5x7	M4	4	7	6.4	8.1	10.8	80	40	40	120	1290	AR 15 FS
AR 15 FN	24	18.5	15	15	60		52	56.1	39.5	20.1	26	41	4.5	M5x7	M4	4	7	9.0	11.3	17.5	140	100	100	180		AR 15 FN
AR 20 MS	28	11	20	20	60	9.5x6x8.5	42	48.2	30	22.5	-	32	12	M5x7	-	3.5	8	10.9	13.7	16.3	170	80	80	148	2280	AR 20 MS
AR 20 FS	28	19.5	20	20	60		59	48.2	30	22.5	-	49	12	M6x9	M5	3.5	9	10.9	13.7	16.3	170	80	80	185		AR 20 FS
AR 20 FN	28	19.5	20	20	60		59	70.2	52	22.5	32	49	12	M6x9	M5	3.5	9	15.6	19.7	29.8	310	220	220	299		AR 20 FN
AR 25 MS	33	12.5	23	23	60	11x7x9	48	57.2	37	26.6	-	35	12	M6x9	-	5	8	12.3	15.5	21.2	220	110	110	285	3020	AR 25 MS
AR 25 MN	33	12.5	23	23	60		48	80.2	60	26.6	35	35	12	M6x9	-	5	8	18.8	23.7	36.4	410	300	300	380		AR 25 MN
AR 25 FS	33	25	23	23	60		73	57.2	37	26.6	-	60	12	M8x10	M6	5	10	12.3	15.5	21.2	220	110	110	325		AR 25 FS

### HR Series

HR 20 FL	30	21.5	20	20	60	9.5x6x8.5	63	90.2	72	24.5	40	53	12	M6x9	M5	5.5	9	20.8	26.2	43.3	430	420	420	496	2280	HR 20 FL
HR 25 MN	40	12.5	23	23	60	11x7x9	48	80.2	60	33.6	35	35	12	M6x9	-	12	12	18.8	23.7	36.4	410	300	300	530	3020	HR 25 MN
HR 25 FL	36	23.5	23	23	60		70	100.2	80	29.6	45	57	12	M8x10	M6	8	10	23.4	29.5	48.5	560	520	520	585		HR 25 FL

### ER Series

ER 25 MN	36	12.5	23	23	60	11x7x9	48	80.2	60	29.6	35	35	12	M6x9	-	8	8	18.8	23.7	36.4	410	300	300	432	3020	ER 25 MN
----------	----	------	----	----	----	--------	----	------	----	------	----	----	----	------	---	---	---	------	------	------	-----	-----	-----	-----	------	----------

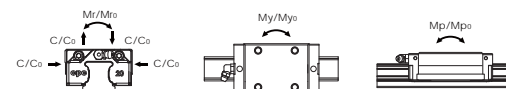

The above rating load capacities and static moments are calculated according to the ISO14728 standard. The rating life for basic dynamic load ratings is defined as the total 100km travel distance for 90% of a group of identical linear guides, under the same conditions and free from any material damage caused by rolling fatigue. If a standard of 50km travel distance is applied to measure the average product lifespan, the above basic dynamic load rating C should be multiplied by 1.26 for an accurate conversion.

## Dimensions Table

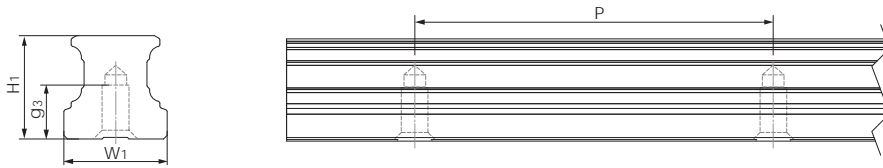

Rail (tapped from the bottom)

Model Code	W1	H1	P	Mxg3	Lmax	Rail(g/m)
ARU 15	15	15	60	M5x8	4000	1290
ARU 20	20	20	60	M6x10	4000	2280
ARU 25	23	23	60	M6x12	4000	3020
ARU 30	28	27	80	M8x15	4000	4380
ARU 35	34	32	80	M8x15	4000	6790
ARU 45	45	39	105	M12x19	4000	10530
ARU 55	53	45.7	120	M14x24	4000	14060

## Nipple Option

Type		Nipple size		Grease nipple	Optional				
		Section	Side		Standard	Straight adapter	Tube diameter	L-Type adapter	Tube diameter
ARC15	HRC15	-	M3	M3	A-M3	OA-M3-D4	-	OB-M3-M6	-
ARC20	HRC20	-	M3	M3	B-M3	OA-M3-D4	-	OB-M3-M6	-
ARC25	HRC25	ERC25	M6	M3	B-M6	OA-M6-M8	Ø4	OB-M6-M8	Ø4
ARC30	HRC30	-	M6	M6	B-M6	OA-M6-M8	Ø4	OB-M6-M8	Ø4
						OA-M6-PT1/8	-	OB-M6-PT1/8	-
						OA-M6-G1/8	Ø6	OB-M6-M8	-
ARC35	HRC35	-	M6	M6	B-M6	OA-M6-M8	Ø4	OB-M6-M8	-
						OA-M6-PT1/8	-	OB-M6-PT1/8	-
						OA-M6-G1/8	Ø6	OB-M6-M8	-
ARC45	HRC45	-	PT1/8	M6	B-PT1/8	OA-PT1/8-M8	Ø4	OB-PT1/8-M8	Ø4
						OA-PT1/8-PT1/8	-	OB-PT1/8-PT1/8	-
						OA-PT1/8-G1/8	Ø6	OB-PT1/8-PT1/8	-
ARC55	HRC55	-	M6	M6	B-M6	OA-M6-M8	Ø4	OB-M6-M8	Ø4
						OA-M6-PT1/8	-	OB-M6-M8	-
						OA-M6-G1/8	Ø6	OB-M6-PT1/8	-



WRC series  
Wide Rail Ball Type Linear Guide Series

## Ordering information

### Model code

WRC	U	21/15	M	N	B	2	C	V1	P	-1480L	-20	-20	II	/J
Customization code (Please refer to page 14)														
Number of rails on the same moving axis														
End hole pitch (mm)														
Starting hole pitch (mm)														
Rail length (mm)														
Accuracy grade : UP, SP, P, H, N (Please refer to page 13)														
Preload class : VC, V0, V1, V2 (Please refer to page 12)														
C: with ball chain (Please refer to page 07)														
Block quantity														
Seal type : B: Low friction														
Block length : N: standard														
Block width : M: standard F: flanged														
Block type : 21/15, 27/20														
U: rail (tapped from the bottom)														
Product type : WRC: Wide Rail Ball Type Linear Guide Series														

## Dimensions Table

WRU Series Rail (tapped from the bottom)



Model Code	W1	H1	P	P3	Mxg3	Lmax	Rail(g/m)
WRU 21/15	37	14.4	50	22	M4x8	4000	3596
WRU 27/20	42	18.5	60	24	M5x7.5	4000	5259

Dimensions Table

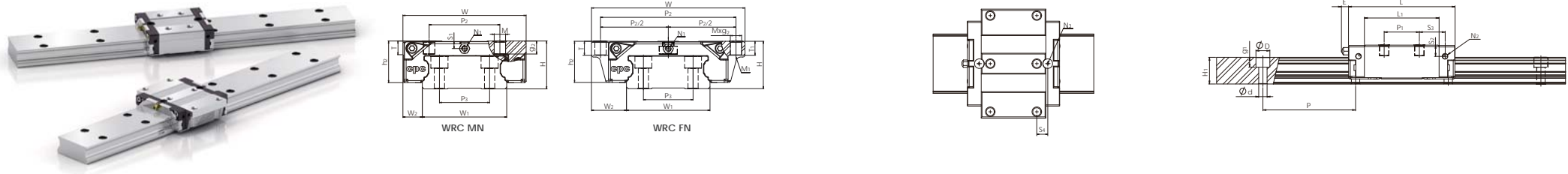

WRC Series

Model Code	Mounting Dimensions		Rail Dimensions(mm)				Block Dimensions(mm)											Block Dimensions(mm)				Load Capacities (KN)		Static Moment (Nm)			Weight		Model Code					
	H	W <sub>2</sub>	W <sub>1</sub>	H <sub>1</sub>	P	P <sub>3</sub>	D <sub>x</sub> d <sub>x</sub> g <sub>1</sub>	W	L	L <sub>1</sub>	h <sub>2</sub>	P <sub>1</sub>	P <sub>2</sub>	M <sub>x</sub> g <sub>2</sub>	M <sub>1</sub>	T	T <sub>1</sub>	N <sub>1</sub>	N <sub>2</sub>	N <sub>3</sub>	E	S <sub>1</sub>	S <sub>2</sub>	S <sub>3</sub>	S <sub>4</sub>	C <sub>ISO</sub>		C <sub>0</sub>		M <sub>r0</sub>	M <sub>p0</sub>	M <sub>y0</sub>	Block(g)	Rail(g/m)
																										100km	50km							
WRC 21/15 MN	21	8.5	37	14.4	50	22	7.5x4.5x5.3	54	57.5	40.3	18.3	19	31	M5x5	-	6	-	M3	M3x3	P3	3.5	3.3	6.1	13.9	11.9	9.9	12.5	17.5	315	105	105	160	3596	WRC 21/15 MN
WRC 21/15 FN	21	15.5	37	14.4	50	22	7.5x4.5x5.3	68	57.5	40.3	18.3	29	60	M5x6	M4	6	6	M3	M3x3	P3	3.5	3.3	6.1	8.9	6.9	9.9	12.5	17.5	315	105	105	198	3596	WRC 21/15 FN
WRC 27/20 MN	27	10	42	18.5	60	24	7.5x4.5x5.3	62	70	52	23.5	32	46	M6x6	-	10	-	M3	M3x4	P4	3.5	4.5	8	13.2	11.5	17.1	21.5	30	634	230	230	320	5259	WRC 27/20 MN
WRC 27/20 FN	27	19	42	18.5	60	24	7.5x4.5x5.3	80	70	52	23.5	40	70	M6x9	M5	9	9	M3	M3x4	P4	3.5	4.5	8	9.2	7.5	17.1	21.5	30	634	230	230	553	5259	WRC 27/20 FN

The above rating load capacities and static moments are calculated according to the ISO14728 standard. The rating life for basic dynamic load ratings is defined as the total 100km travel distance for 90% of a group of identical linear guides under the same conditions and free from any material damage caused by rolling fatigue. If a standard of 50km travel distance is applied to measure the average product lifespan, the above basic dynamic load rating C should be multiplied by 1.26 for an accurate conversion.

WRC...C Series Ball chain type

Model Code	Mounting Dimensions		Rail Dimensions(mm)				Block Dimensions(mm)											Block Dimensions(mm)				Load Capacities (KN)		Static Moment (Nm)			Weight		Model Code					
	H	W <sub>2</sub>	W <sub>1</sub>	H <sub>1</sub>	P	P <sub>3</sub>	D <sub>x</sub> d <sub>x</sub> g <sub>1</sub>	W	L	L <sub>1</sub>	h <sub>2</sub>	P <sub>1</sub>	P <sub>2</sub>	M <sub>x</sub> g <sub>2</sub>	M <sub>1</sub>	T	T <sub>1</sub>	N <sub>1</sub>	N <sub>2</sub>	N <sub>3</sub>	E	S <sub>1</sub>	S <sub>2</sub>	S <sub>3</sub>	S <sub>4</sub>	C <sub>cage</sub>		C <sub>0</sub>		M <sub>r0</sub>	M <sub>p0</sub>	M <sub>y0</sub>	Block(g)	Rail(g/m)
																										100km	50km							
WRC 21/15 MN...C	21	8.5	37	14.4	50	22	7.5x4.5x5.3	54	57.5	40.3	18.3	19	31	M5x5	-	6	-	M3	M3x3	P3	3.5	3.3	6.1	13.9	11.9	11.8	14.9	16.2	295	95	95	159	3596	WRC 21/15 MN...C
WRC 21/15 FN...C	21	15.5	37	14.4	50	22	7.5x4.5x5.3	68	57.5	40.3	18.3	29	60	M5x6	M4	6	6	M3	M3x3	P3	3.5	3.3	6.1	8.9	6.9	11.8	14.9	16.2	295	95	95	197.5	3596	WRC 21/15 FN...C
WRC 27/20 MN...C	27	10	42	18.5	60	24	7.5x4.5x5.3	62	70	52	23.5	32	46	M6x6	-	10	-	M3	M3x4	P4	3.5	4.5	8	13.2	11.5	22.3	28.1	25.7	535	200	200	318	5259	WRC 27/20 MN...C
WRC 27/20 FN...C	27	19	42	18.5	60	24	7.5x4.5x5.3	80	70	52	23.5	40	70	M6x9	M5	9	9	M3	M3x4	P4	3.5	4.5	8	9.2	7.5	22.3	28.1	25.7	535	200	200	550	5259	WRC 27/20 FN...C

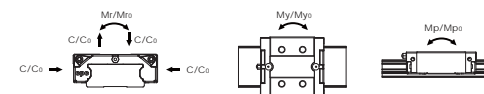

The dynamic load rating value with ball chain Cage is the measured value (please refer to page 08). The above static load rating and the static moment are calculated according to the ISO 14728 standard.



## Product Overview

### LRR Extremely Low Profile Type

Suitable for conditions where a lower external torque and inertial force is required, this product combines a low height and center of gravity to provide a more compact product. ARR, HRR and LRRs blocks all share the same rail with a similar load capacity and service life.

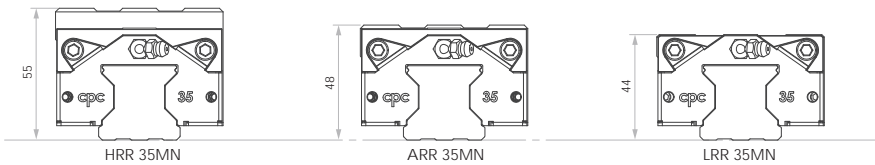

### MXL Ultra Long Block Type

Compared to the industry's ML lengthened block, the MXL model's much lengthened block features a greater load, rigidity and shock reduction capability. This makes this model most suitable for machine tools that require super high rigidity and accuracy.

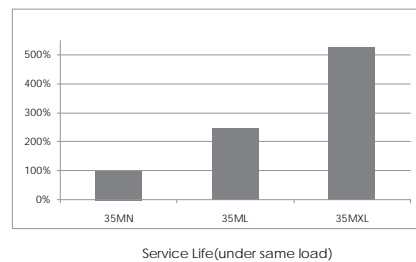
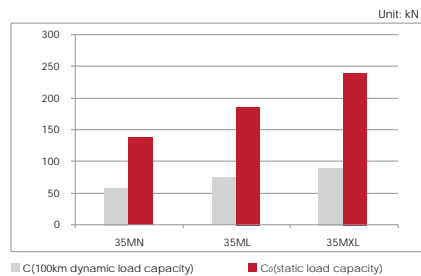
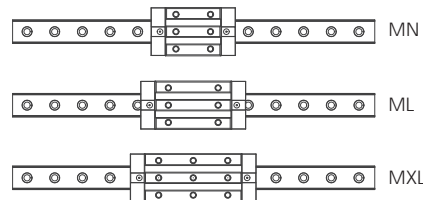

## Parts information

### Low Noise Roller Chain (Optional)

Our Ball chain design effectively lowers high frequency noise volumes while sliding and enhancing smoothness. Additionally, the ball chain spacer between steel rollers continuously replenishes the oil film cladding to maintain a better lubrication effect.

(For more information please refer to page 07)

### Full Cover Seal (Standard Feature)

All model type are equipped with an "end seal", "bottom seal", and "inner seal" to effectively prevent foreign objects from sliding into the block or lubrication from leaking out.

(For more information please refer to page 03)

### NBR Seal (Optional)

The seal demonstrates a high dustproof ability to be used in high dust particle working environments, being ideally placed in wood-working machines, glass processing machines, graphite processing machines and grinders. On the outer side of the seal is equipped a stainless steel scraper, with the clearance between the inner and rail contour measuring at only 0.2-0.3mm. This can prevent comparatively large foreign objects from damaging the rubber seal.

(For more information please refer to page 09)

### High Rigidity Stainless Steel Reinforcement Plate (Standard Feature)

Our L-shaped design is locked with end and bottom screws on the block body. The bottom of the body is equipped with an integrated bolt, which allows for the tight fixing of the reinforcement plate to prevent unnecessary block damage from cracking the plastic mountings.

(For more information please refer to page 06)

### Metal-Plastic-Cap (Standard Feature)

Stainless steel covers can demonstrate excellent friction resistance under harsh environments. Inside, the hole plug is equipped with fixed plastic support, enabling for easy installation and direct installation on a standard rail. Contact between the unit support part and stigma screws can prevent overly deep fastening during installation, while also preventing cap indentation and foreign objects from stacking while sliding.

(For more information please refer to page 10)

## Ordering Information

### Model Code

ARR	U	35	M	N	S	2	C	V1	P	-1480L	-20	-20	II	/J	Customization code (please refer to page 14)
													Number of rails on the same moving axis		
													End hole pitch(mm)		
													Starting hole pitch(mm)		
													Rail length(mm)		
													Accuracy grade: UP, SP, P, H (please refer to page 13)		
													Preload class: V0, V1, V2		
													C: with ball chain (please refer to page 07)		
													Block quantity		
													Seal type: S:standard		
													Block length: N:standard L:long XL:extra long		
													Block width: M:standard F:flanged		
													Block type: 35		
													U: Rail (tapped from the bottom)		
Product type: ARR: Low Profile Type    HRR: High Profile Type    LRR: Extremely Low Profile Type															



## Dimensions Table

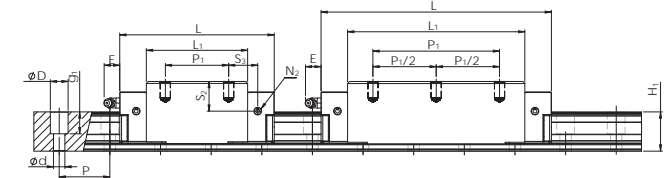
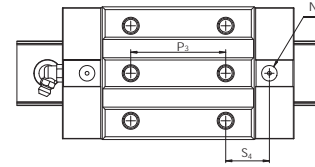
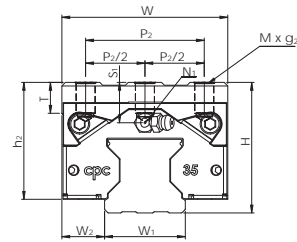

### ARR MN/ML/MXL Series

Model Code	Mounting Dimensions		Rail Dimensions(mm)				Block Dimensions(mm)											Block Dimensions(mm)				Load Capacities (KN)		Static Moment (Nm)			Weight		Model Code					
	H	W <sub>2</sub>	W <sub>1</sub>	H <sub>1</sub>	P	D <sub>x</sub> d <sub>x</sub> g <sub>1</sub>	W	L	L <sub>1</sub>	h <sub>2</sub>	P <sub>1</sub>	P <sub>1/2</sub>	P <sub>2</sub>	P <sub>2/2</sub>	P <sub>3</sub>	M x g <sub>2</sub>	M <sub>1</sub>	T	N <sub>1</sub>	N <sub>2</sub>	N <sub>3</sub>	E	S <sub>1</sub>	S <sub>2</sub>	S <sub>3</sub>	S <sub>4</sub>	C <sub>iso100km</sub>	C <sub>0</sub>		M <sub>r0</sub>	M <sub>p0</sub>	M <sub>y0</sub>	Block(g)	Rail(g/m)
ARR 35MN	48	18	34	31	40	14x9x17	70	122	84	42	50	-	50	25	50	M8x13	-	13	M6x12	M6x8	P5	12	10	16.4	25	25	57	154	2742	1946	1946	1200	5740	ARR 35MN
ARR 35ML	48	18	34	31	40	14x9x17	70	147.5	109.5	42	72	-	50	25	72	M8x13	-	13	M6x12	M6x8	P5	12	10	16.4	26.7	26.7	68.9	196	3525	3226	3226	1750	5740	ARR 35ML

### HRR MN/ML/MXL Series

HRR 35MN	55	18	34	31	40	14x9x17	70	122	84	49	50	-	50	25	50	M8x16	-	13	M6x12	M6x8	P5	12	17	23.4	25	25	57	154	2742	1946	1946	1720	5740	HRR 35MN
HRR 35ML	55	18	34	31	40	14x9x17	70	147.5	109.5	49	72	-	50	25	72	M8x16	-	13	M6x12	M6x8	P5	12	17	23.4	26.7	26.7	68.9	196	3525	3226	3226	2100	5740	HRR 35ML
HRR 35MXL	55	18	34	31	40	14x9x17	70	177.5	139.5	49	100	50	50	25	100	M8x16	-	13	M6x12	M6x8	P5	12	17	23.4	27.7	27.7	82	245	4439	5111	5111	2700	5740	HRR 35MXL

### LRR MN/ML/MXL Series

LRR 35MN	44	18	34	31	40	14x9x17	70	122	84	38	50	-	50	25	50	M8x9	-	9	M6x12	M6x8	P5	12	6	12.4	25	25	57	154	2742	1946	1946	1100	5740	LRR 35MN
LRR 35ML	44	18	34	31	40	14x9x17	70	147.5	109.5	38	72	-	50	25	72	M8x9	-	9	M6x12	M6x8	P5	12	6	12.4	26.7	26.7	68.9	196	3525	3226	3226	1500	5740	LRR 35ML
LRR 35MXL	44	18	34	31	40	14x9x17	70	177.5	139.5	38	100	50	50	25	100	M8x9	-	9	M6x12	M6x8	P5	12	6	12.4	27.7	27.7	82	245	4439	5111	5111	1900	5740	LRR 35MXL

- The load capacity is measured for the full-ball type (without ball chain)
- N<sub>2</sub> = Injecting holes
- N<sub>3</sub> = O-ring size for lubrication from above
- N<sub>3</sub> will be sealed before shipment, please open it when first using the product.

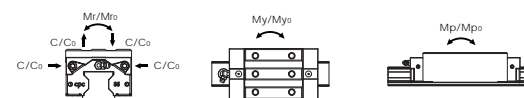

The above rating load capacities and static moments are calculated according to the ISO14728 standard. The rating life for basic dynamic load ratings is defined as the total 100km travel distance for 90% of a group of identical linear guides, under the same conditions and free from any material damage caused by rolling fatigue. If a standard of 50km travel distance is applied to measure the average product lifespan, the above basic dynamic load rating C should be multiplied by 1.26 for an accurate conversion.

## Dimensions Table

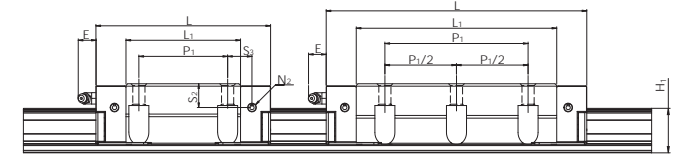
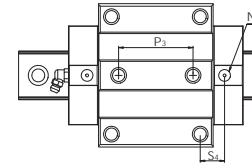
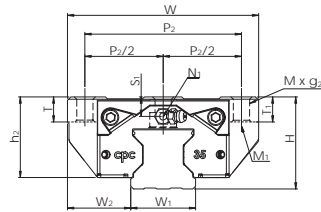

### HRR FN/FL/FXL Series

Model Code	Mounting Dimensions		Rail Dimensions(mm)				Block Dimensions(mm)											Block Dimensions(mm)				Load Capacities (KN)		Static Moment (Nm)			Weight		Model Code						
	H	W <sub>2</sub>	W <sub>1</sub>	H <sub>1</sub>	P	D <sub>x</sub> d <sub>x</sub> g <sub>1</sub>	W	L	L <sub>1</sub>	h <sub>2</sub>	P <sub>1</sub>	P <sub>1/2</sub>	P <sub>2</sub>	P <sub>2/2</sub>	P <sub>3</sub>	M x g <sub>2</sub>	M <sub>1</sub>	T	T <sub>1</sub>	N <sub>1</sub>	N <sub>2</sub>	N <sub>3</sub>	E	S <sub>1</sub>	S <sub>2</sub>	S <sub>3</sub>	S <sub>4</sub>	C <sub>iso100km</sub>		C <sub>0</sub>	M <sub>ro</sub>	M <sub>po</sub>	M <sub>yo</sub>	Block(g)	Rail(g/m)
HRR 35FN	48	33	34	31	40	14x9x17	100	122	84	42	62	-	82	41	52	M10x13	M8	13	13	M6x12	M6x8	P5	12	10	16.4	19	19	57	154	2742	1946	1946	1700	5740	HRR 35FN
HRR 35FL	48	33	34	31	40	14x9x17	100	147.5	109.5	42	62	-	82	41	52	M10x13	M8	13	13	M6x12	M6x8	P5	12	10	16.4	31.7	31.7	68.9	196	3525	3226	3226	2400	5740	HRR 35FL
HRR 35FXL	48	33	34	31	40	14x9x17	100	177.5	139.5	42	100	50	82	41	100	M10x13	M8	13	13	M6x12	M6x8	P5	12	10	16.4	27.7	27.7	82	245	4439	5111	5111	3100	5740	HRR 35FXL

### LRR FN/FL/FXL Series

LRR 35FN	44	33	34	31	40	14x9x17	100	122	84	38	62	-	82	41	52	M10x9	M8	9	9	M6x12	M6x8	P5	12	6	12.4	19	19	57	154	2742	1946	1946	1550	5740	LRR 35FN
LRR 35FL	44	33	34	31	40	14x9x17	100	147.5	109.5	38	62	-	82	41	52	M10x9	M8	9	9	M6x12	M6x8	P5	12	6	12.4	31.7	31.7	68.9	196	3525	3226	3226	2200	5740	LRR 35FL
LRR 35FXL	44	33	34	31	40	14x9x17	100	177.5	139.5	38	100	50	82	41	100	M10x9	M8	9	9	M6x12	M6x8	P5	12	6	12.4	27.7	27.7	82	245	4439	5111	5111	2800	5740	LRR 35FXL

1. The load capacity is measured for the full-ball type (without ball chain)

2. N<sub>2</sub> = Injecting holes

3. N<sub>2</sub> = O-ring size for lubrication from above

4. N<sub>2</sub>, N<sub>3</sub> will be sealed before shipment, please open it when first using the product.

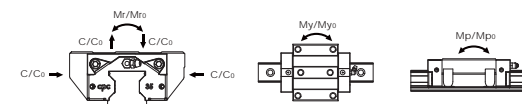

The above rating load capacities and static moments are calculated according to the ISO14728 standard. The rating life for basic dynamic load ratings is defined as the total 100km travel distance for 90% of a group of identical linear guides, under the same conditions and free from any material damage caused by rolling fatigue. If a standard of 50km travel distance is applied to measure the average product lifespan, the above basic dynamic load rating C should be multiplied by 1.26 for an accurate conversion.

## Dimensions Table

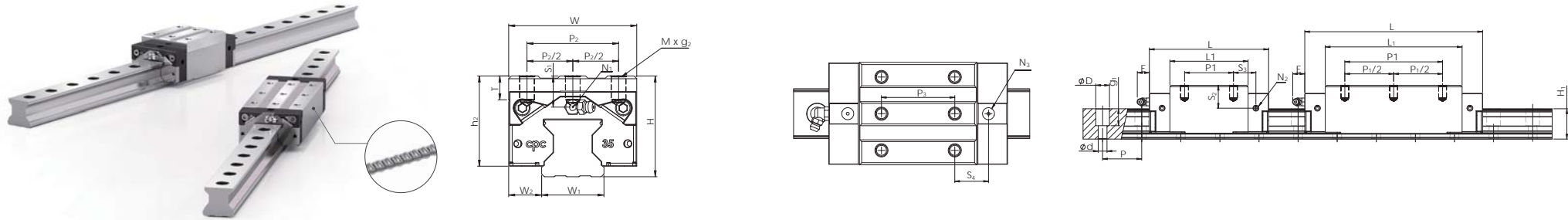

### ARR MN/ML/MXL...C Series (Ball chain type)

Model Code	Mounting Dimensions		Rail Dimensions(mm)				Block Dimensions(mm)											Block Dimensions(mm)				Load Capacities (KN)		Static Moment (Nm)			Weight		Model Code					
	H	W <sub>2</sub>	W <sub>1</sub>	H <sub>1</sub>	P	D <sub>x</sub> d <sub>x</sub> g <sub>1</sub>	W	L	L <sub>1</sub>	h <sub>2</sub>	P <sub>1</sub>	P <sub>1</sub> /2	P <sub>2</sub>	P <sub>2</sub> /2	P <sub>3</sub>	M x g <sub>2</sub>	M <sub>1</sub>	T	N <sub>1</sub>	N <sub>2</sub>	N <sub>3</sub>	E	S <sub>1</sub>	S <sub>2</sub>	S <sub>3</sub>	S <sub>4</sub>	C <sub> cage 100km</sub>	C <sub>0</sub>		M <sub>r0</sub>	M <sub>p0</sub>	M <sub>y0</sub>	Block(g)	Rail(g/m)
ARR 35MN	48	18	34	31	40	14x9x17	70	122	84	42	50	-	50	25	50	M8x13	-	13	M6x12	M6x8	P5	12	10	16.4	25	25	71.3	133	2350	1710	1710	1200	5800	ARR 35MN
ARR 35ML	48	18	34	31	40	14x9x17	70	147.5	109.5	42	72	-	50	25	72	M8x13	-	13	M6x12	M6x8	P5	12	10	16.4	26.7	26.7	86.1	175	3133	2881	2881	1750	5850	ARR 35ML

### HRR MN/ML/MXL...C Series (Ball chain type)

HRR 35MN	55	18	34	31	40	14x9x17	70	122	84	49	50	-	50	25	50	M8x16	-	13	M6x12	M6x8	P5	12	17	23.4	25	25	71.3	133	2350	1710	1710	1720	5721	HRR 35MN
HRR 35ML	55	18	34	31	40	14x9x17	70	147.5	109.5	49	72	-	50	25	72	M8x16	-	13	M6x12	M6x8	P5	12	17	23.4	26.7	26.7	86.1	175	3133	2881	2881	2100	5850	HRR 35ML
HRR 35MXL	55	18	34	31	40	14x9x17	70	177.5	139.5	49	100	50	50	25	100	M8x16	-	13	M6x12	M6x8	P5	12	17	23.4	27.7	27.7	102.5	224	4047	4695	4695	2700	5850	HRR 35MXL

### LRR MN/ML/MXL...C Series (Ball chain type)

LRR 35MN	44	18	34	31	40	14x9x17	70	122	84	38	50	-	50	25	50	M8x9	-	9	M6x12	M6x8	P5	12	6	12.4	25	25	71.3	133	2350	1710	1710	1100	5850	LRR 35MN
LRR 35ML	44	18	34	31	40	14x9x17	70	147.5	109.5	38	72	-	50	25	72	M8x9	-	9	M6x12	M6x8	P5	12	6	12.4	26.7	26.7	86.1	175	3133	2881	2881	1500	5850	LRR 35ML
LRR 35MXL	44	18	34	31	40	14x9x17	70	177.5	139.5	38	100	50	50	25	100	M8x9	-	9	M6x12	M6x8	P5	12	6	12.4	27.7	27.7	102.5	224	4047	4695	4695	1900	5850	LRR 35MXL

- N<sub>2</sub> = Injecting holes
- N<sub>3</sub> = O-ring size for lubrication from above
- N<sub>2</sub>, N<sub>3</sub> will be sealed before shipment, please open it when first using the product.

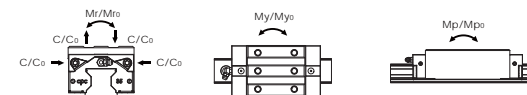

The measured value is the dynamic load rating value with ball chain C<sub>age</sub>. The above static load rating and the static moment are calculated according to the ISO 14728 standard.

## Dimensions Table

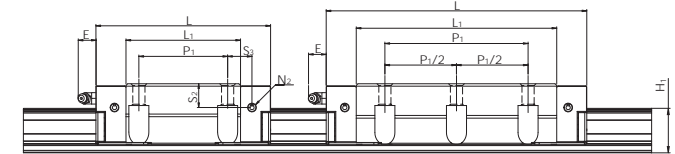
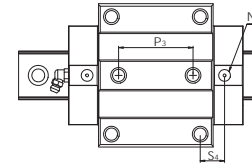
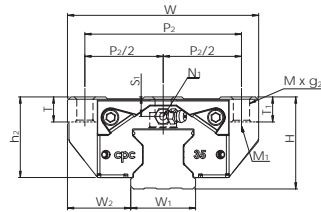

### HRR FN/FL/FXL...C Series (Ball chain type)

Model Code	Mounting Dimensions		Rail Dimensions(mm)				Block Dimensions(mm)											Block Dimensions(mm)				Load Capacities (KN)		Static Moment (Nm)			Weight		Model Code						
	H	W <sub>2</sub>	W <sub>1</sub>	H <sub>1</sub>	P	D <sub>x</sub> d <sub>x</sub> g <sub>1</sub>	W	L	L <sub>1</sub>	h <sub>2</sub>	P <sub>1</sub>	P <sub>1/2</sub>	P <sub>2</sub>	P <sub>2/2</sub>	P <sub>3</sub>	M x G <sub>2</sub>	M <sub>1</sub>	T	T <sub>1</sub>	N <sub>1</sub>	N <sub>2</sub>	N <sub>3</sub>	E	S <sub>1</sub>	S <sub>2</sub>	S <sub>3</sub>	S <sub>4</sub>	C <sub>age</sub> 100km		C <sub>0</sub>	M <sub>r0</sub>	M <sub>p0</sub>	M <sub>y0</sub>	Block(g)	Rail(g/m)
HRR 35FN	48	33	34	31	40	14x9x17	100	122	84	42	62	-	82	41	52	M10x13	M8	13	13	M6x12	M6x8	P5	12	10	16.4	19	19	71.3	133	2350	1710	1710	1700	5800	HRR 35FN
HRR 35FL	48	33	34	31	40	14x9x17	100	147.5	109.5	42	62	-	82	41	52	M10x13	M8	13	13	M6x12	M6x8	P5	12	10	16.4	31.7	31.7	86.1	175	3133	2881	2881	2400	5800	HRR 35FL
HRR 35FXL	48	33	34	31	40	14x9x17	100	177.5	139.5	42	100	50	82	41	100	M10x13	M8	13	13	M6x12	M6x8	P5	12	10	16.4	27.7	27.7	102.5	224	4047	4695	4695	3100	5800	HRR 35FXL

### LRR FN/FL/FXL...C Series (Ball chain type)

LRR 35FN	44	33	34	31	40	14x9x17	100	122	84	38	62	-	82	41	52	M10x9	M8	9	9	M6x12	M6x8	P5	12	6	12.4	19	19	71.3	133	2350	1710	1710	1550	5800	LRR 35FN
LRR 35FL	44	33	34	31	40	14x9x17	100	147.5	109.5	38	62	-	82	41	52	M10x9	M8	9	9	M6x12	M6x8	P5	12	6	12.4	31.7	31.7	86.1	175	3133	2881	2881	2200	5800	LRR 35FL
LRR 35FXL	44	33	34	31	40	14x9x17	100	177.5	139.5	38	100	50	82	41	100	M10x9	M8	9	9	M6x12	M6x8	P5	12	6	12.4	27.7	27.7	102.5	224	4047	4695	4695	2800	5800	LRR 35FXL

- N<sub>2</sub> = Injecting holes
- N<sub>3</sub> = O-ring size for lubrication from above
- N<sub>2</sub>, N<sub>3</sub> will be sealed before shipment, please open it when first using the product.

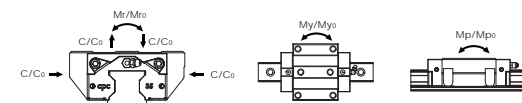

The measured value is the dynamic load rating value with ball chain C<sub>age</sub>. The above static load rating and the static moment are calculated according to the ISO 14728 standard.

Nipple Option

Grease nipple/ Oil piping joint

<p>A - M 3</p>	<p>B - M 3</p>	<p>B - M 6</p> <p>JIS B 1517 DIN 71 412 ISO 6392-1 ISO 7824</p>	<p>B - PT 1 / 8</p> <p>JIS B 1517 DIN 71 412 ISO 6392-1 ISO 7824</p>
<p>OB - M 3 - M 6</p>	<p>OA - M3 - D4</p>	<p>OA - M6 - M8</p> <p>Ø 4 Oil hole grease injector available</p>	<p>OA - M6 - PT1 / 8</p>
<p>OA - M6 - G1 / 8</p> <p>Ø 6 Oil hole grease injector available</p>	<p>OB - M6 - M8</p> <p>Ø 4 Oil hole grease injector available</p>	<p>OB - M6 - PT1 / 8</p>	<p>OA - PT1 / 8 - M8</p> <p>Ø 4 Oil hole grease injector available</p>
<p>OA - PT1 / 8 - PT1 / 8</p>	<p>OA - PT1 / 8 - G1 / 8</p> <p>Ø 6 Oil hole grease injector available</p>	<p>OB - PT1 / 8 - M8</p> <p>Ø 4 Oil hole grease injector available</p>	<p>OB - PT1 / 8 - PT1 / 8</p>

- The L type nipple is for both ball bearing and roller type external seals (SN)

- The XL type nipple is for the roller type external seal (SN)

Note: in case of need for customization or special requirements, please contact **cpc**

<p>B - M 6 - L</p> <p>JIS B 1517 DIN 71 412 ISO 6392-1 ISO 7824</p>	<p>OA - M6 - M8 - L</p> <p>Ø 4 Oil hole grease injector available</p>	<p>OA - M6 - PT1 / 8 - L</p>	<p>OA - M6 - G1 / 8 - L</p> <p>Ø 6 Oil hole grease injector available</p>
<p>OB - M6 - M8 - L</p> <p>Ø 4 Oil hole grease injector available</p>	<p>OB - M6 - PT1 / 8 - L</p>	<p>A - M 3 - L</p>	<p>B - M 3 - L</p>
<p>B - PT 1 / 8 - L</p> <p>JIS B 1517 DIN 71 412 ISO 6392-1 ISO 7824</p>	<p>B - M 6 - XL</p> <p>JIS B 1517 DIN 71 412 ISO 6392-1 ISO 7824</p>	<p>OA - M6 - M8 - XL</p> <p>Ø 4 Oil hole grease injector available</p>	<p>OA - M6 - PT1 / 8 - XL</p>
<p>OA - M6 - G1 / 8 - XL</p> <p>Ø 6 Oil hole grease injector available</p>	<p>OB - M6 - M8 - XL</p> <p>Ø 4 Oil hole grease injector available</p>	<p>OB - M6 - PT1 / 8 - XL</p>	



Lubrication Kit and Grease Gun

The **cpc** Lubrication Unit is a supply nozzle with 3 different sizes of nozzle adaptors. These nozzle adaptors are suitable for differently sized grease nipples on different sized linear blocks.



Nipple Option

Type			Nipple Size		Nipple Type
			Section	Side	
ARC15	HRC15	-	M3	M3	A-M3
ARC20	HRC20	-	M3	M3	B-M3
ARC25	HRC25	ERC25	M6	M3	B-M6
ARC30	HRC30	-	M6	M6	B-M6
ARC35	HRC35	-	M6	M6	B-M6
ARC45	HRC45	-	PT1/8	M6	B-PT1/8
ARC55	HRC55	-	M6	M6	B-M6

GP-PT1/8-01 Lubrication Kit

The Lubrication Kit comes equipped with a supply nozzle (GT-1/8-M5) and three kinds of different nozzle adapters (GH-M5-MR, GH-M5-06, GH-M5-08). The supply nozzle can be mounted on the main body of the common manual or pneumatic grease gun with PT1/8 tapped connectors widely available on the market.

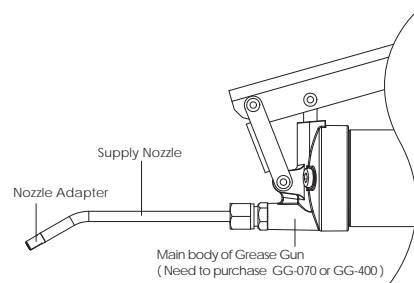

Greasing Diagram

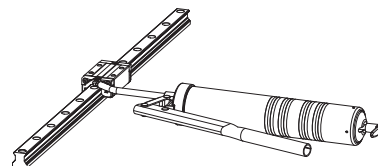

Supply Nozzle

Type	Dimension
GT-PT1/8-M5	

Nozzle Adapter

Unit: mm

Type	Dimension	Grease Nipple	
GH-M5-MR		MR series Miniature linear guide size MR-15M \ MR-15W MR-12M \ MR-12W	
GH-M5-06		A-M3 A-M3X	
		B-M3 B-M3X	
GH-M5-08		B-M6 B-M6X	
		B-PT1/8 B-PT1/8X	

Main body of Grease Gun

Option for the main body of the Grease Gun: GG-070 for 70g volume grease pack and GG-400 for 400g volume grease pack.

Unit: mm

Type	Dimension	Feature
GG-070		<ol style="list-style-type: none"> <li>1. Pressure: 27Mpa</li> <li>2. Output Volume: 0.5-0.7 c.c/stroke</li> <li>3. Grease: Suitable for 70g volume grease pack or bulk loading</li> </ol>
GG-400		<ol style="list-style-type: none"> <li>1. Pressure: 62Mpa</li> <li>2. Output Volume: 1.0-1.2 c.c/stroke</li> <li>3. Grease: Suitable for 400g volume grease pack or bulk loading</li> </ol>

## cpc AR/HR Z Series Lubrication Storage Pad Testing Report

A linear guide is a category of rolling guidance systems. By using unlimited recirculating stainless steel balls that operate between the raceways of the rail and the runner block, the carriage achieves high precision and low friction linear movement. If the linear guides do not have sufficient lubrication, rolling friction will increase, causing wear and shortened linear guide lifespan.

cpc has added and embedded PU lubricant storage pads to prolong the life of the linear guide; the pads directly contact and lubricate the rolling balls. This design supplies sufficient lubrication even in short stroke operations.

cpc's design, due to the embedded pads absorption and retention capabilities, results in a product that features a long operation life and long-term lubrication.

Following are the results of cpc's in-house testing.

### AR15 Lubrication Storage Pad Testing Data

Tested products: AR15 blocks with lubrication storage pads, 8 pieces, and AR15 rails, N accuracy grade, 1500mm Length, 4 pieces

Testing condition	
Rating load capacities(each block)	1.8kN(C=9kN · C0=17.5kN)
Stroke	0.96m
Max running speed	1m/s
Lubricant	DAPHNE SUPER MULTI 68 (Viscosity64.32 CST 400C)
Lubrication period	No lubrication added during testing period

### ■ Testing equipment



### ■ Testing result

Dried lubricant residue started appearing on rail profile, PU pads, and ball retainer of the tested blocks

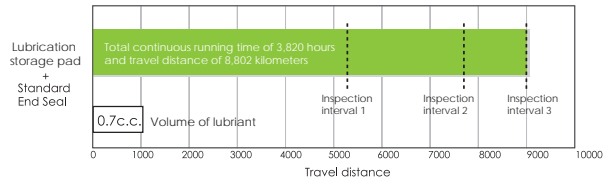

### ■ Test results at inspection intervals

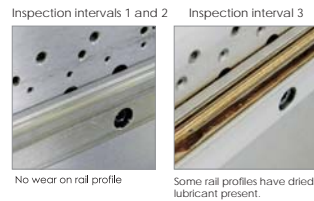

#### Inspection intervals 1 and 2: Lubrication Maintained



- Upward lubrication storage pads in good condition.
- Downward lubrication storage pads in good condition.
- Lubricant supply in good condition.
- Lubricant supply in good condition.
- No wear on the running profile of the rail.

#### Inspection interval 3: Lubricant residue



- Dried lubricant residue and breakage on the upward lubrication storage pads
- Dried lubricant residue and breakage on the downward lubrication storage pads.

#### Plastic parts and end seal in good condition



Plastic parts in good condition      End seal in good condition

### ■ Test Summary

Total continuous running time of 3820 hours and travel distance of 8802 kilometers.  
Out of eight test blocks, dried lubricant residue appeared on 2 blocks and 1 rail.  
Dried lubricant residue is indicative of a need for relubrication and thus lengthens the operational life of the linear guide.