

# JABEZ

雅比斯國際有限公司  
Jabez International Co., Ltd.

## TK45 PRODUCT LIST



## TK120 PRODUCT LIST



402台中市南區三民西路342號

ADD:  
No.342, Sanmin W. Rd., South Dist.,  
Taichung City 402, Taiwan (R.O.C.)

TEL: 04-23781018 FAX: 04-23780938

Email: jabez.aai@gmail.com  
Web: www.jabez-ai.com



# JABEZ

雅比斯國際有限公司

Support Arm and Control Panel Systems

懸臂、控制面板系統



懸臂、控制面板系統  
專業品牌

www.jabez-ai.com





**JABEZ**  
雅比斯國際有限公司  
Jabez International Co., Ltd.

## INDEX

- |                                      |  |
|--------------------------------------|--|
| <b>01</b> TK 120 Series Product List | <b>50</b> ECO 120 Series Panel                 |
| <b>02</b> TK 060 Series Product List | <b>56</b> ECO 150 Series Panel                 |
| <b>03</b> TK 040 Series Product List | <b>63</b> Separator Applications               |
| <b>10</b> TK 120 Product Details     | <b>64</b> TKP 2000 Series Panel                |
| <b>16</b> TK 060 Product Details     | <b>66</b> Panel Assembling Application Samples |
| <b>24</b> TK 040 Product Details     | <b>69</b> Front Sheet List                     |
| <b>30</b> TK 045 Product Details     | <b>70</b> Stand Systems                        |
| <b>32</b> Application Samples        | <b>80</b> Coupling Towers                      |
| <b>38</b> ECO 060 Series Panel       | <b>82</b> Warning Lamps                        |
| <b>44</b> ECO 090 Series Panel       |  |

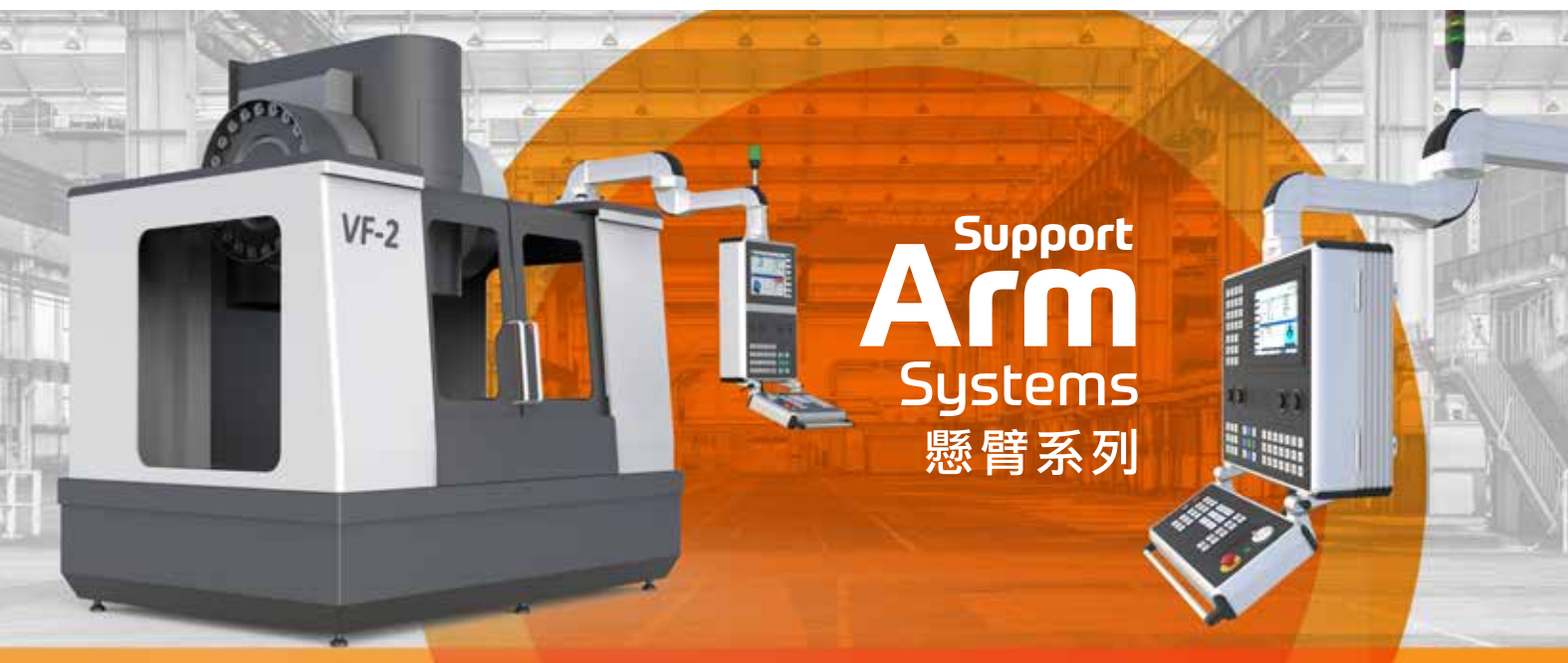











JABEZ雅比斯國際有限公司專注於鋁合金支撐臂懸臂與操控面板操控箱等產品，多年來與工具機製造業者，AI自動化業者，進行密切溝通與了解，提供各式解決方案，研發設計兼具功能設計與美觀的连接組件，無論是懸臂支撐臂左右旋轉，或操控面板操控箱水平旋轉310度，及上下仰角 $\pm 45$ 度等，親近符合操作人員人體工學的設計，我們正持續不斷的追求創新與突破，嚴選多樣品牌以滿足工具機產業需求。

雅比斯追求完美品質與價格合理化的理念，提供客戶產品附加價值升級的周邊配置系統。機械美學的潮流，支撐臂懸臂及操作面板，是發展中追求卓越不可或缺的配置與趨勢，現代的科技與技術奠定穩健與安全性的產品基礎，泰克諾爾具國際檢測實驗室結構分析與檢測合格，實用新型專利與外觀設計註冊及CE認證證書。

雅比斯為了推廣懸臂支撐臂模組化結構設計組件的解決方案，及鋁合金材質操作面板輕量化且功能多樣化，現代鈹金美學的設計外觀，我們創新應用現代資訊科技，突破業界傳統的推廣思維，以專業設計的網頁功能，讓客戶端設計工程師方便且迅速地了解產品功能與應用，詢價系統即時提供客戶所需的價格資訊，專業的業務團隊，協助客戶有效率地評估應用規劃與成本。

在這瞬息萬變的國際市場，雅比斯以誠信、創新、卓越、服務、熱忱的理念，期許引領台灣、亞洲機械美學風潮，接軌國際潮流，共創亮眼佳績。

TK120 PRODUCT LIST











	Model No	Description	Rotatable Tilting	Fixed	Length mm	Weight gr	Color No Ral No	Package
	TK120.025	120 Support Profile - 250 mm 連接管		✓	250	1950	7035	1
	TK120.050	120 Support Profile- 500 mm 連接管		✓	500	3900	7035	1
	TK120.075	120 Support Profile - 750 mm 連接管		✓	750	5850	7035	1
	TK120.100	120 Support Profile- 1000 mm 連接管		✓	1000	7800	7035	1
	TK120.125	120 Support Profile - 1250 mm 連接管		✓	1250	9750	7035	1
	TK120.150	120 Support Profile - 1500 mm 連接管		✓	1500	11700	7035	1
	TK120.175	120 Support Profile - 1750 mm 連接管		✓	1750	13650	7035	1
	TK120.200	120 Support Profile -2000 mm 連接管		✓	2000	15600	7035	1
	TK120.320	Rotatable Panel Coupling 箱體連接件	✓			1315	7035	1
	TK120.321	Rotatable Panel Coupling 底部箱體連接件	✓			1315	7035	1
	TK120.330	TKP2000 Rotatable Panel Coupling TKP2000 箱體連接件	✓			1550	7035	1
	TK120.331	TKP2000 Rotatable Panel Coupling TKP2000 箱體連接件	✓			1550	7035	1
	TK120.400	Rotatable Panel 90° Angle Coupling 90°箱體連接件	✓			2365	7035 / 7016	1
	TK120.401	Rotatable Panel 90° Angle Coupling 90°箱體連接件	✓			3275	7035 / 7016	1
	TK120.410	TKP 2000 Rotatable Panel 90° Angle Coupling TKP2000 90°箱體連接件	✓			2575	7035 / 7016	1
	TK120.411	TKP 2000 Rotatable Panel 90° Angle Coupling TKP2000 90°箱體連接件	✓			3510	7035 / 7016	1
	TK120.420	90° Angle Piece 90°轉角		✓		1650	7035 / 7016	1
	TK120.500	Rotatable Intermediate Hinge 中間連接件	✓			5600	7035 / 7016	1

TK120 PRODUCT LIST

	Model No	Description	Rotatable Tilting	Fixed	Length mm	Weight gr	Color No Ral No	Package
	TK120.600	Rotatable Top Mounted 90° Angle Joint 頂座	✓			5710	7035 / 7016	1
	TK120.610	Rotatable Top Mounted Vertical Outlet 可旋轉底座	✓			4820	7035 / 7016	1
	TK120.700	Rotatable Wall-Mounted Hinge Horizontal Outlet 水平牆座	✓			6605	7035 / 7016	1
	TK120.710	Rotatable Wall-Mounted Hinge Vertical Outlet 垂直牆座	✓			5765	7035 / 7016	1
	TK120.800	Wall/Socket Mounting Bracket 固定底座		✓		826	7035/ 7016	1
	TK120.810	Warning Lamp Cover M22 警示燈上蓋		✓		226	7016	1
	TK120.811	Warning Lamp Cover M18 警示燈上蓋		✓		236	7016	1
	TK120.820	TK120/060 Support Arm Adaptor 連接管支撐座		✓		560	7035	1
	TK120.843	Tilting Panel Coupling 傾斜箱體連接件	✓			1600	7035 / 7016	1
	TK120.844	TKP 2000 Tilting Panel Coupling TKP2000 傾斜箱體連接件	✓			1830	7035 / 7016	1
	TK120.845	Rotatable Tilting Panel Coupling 傾斜箱體連接件	✓			2225	7035 / 7016	1
	TK120.846	TKP 2000 Rotatable Tilting Panel Coupling TKP2000 旋轉/傾斜箱體連接件	✓			2450	7035 / 7016	1



TK060 PRODUCT LIST

	Model No	Description	Rotatable Tilting	Fixed	Length mm	Weight gr	Color No Ral No	Package
	TK060.025	O60 Support Profile- 250 mm 連接管		✓	250	950 gr	7035	1
	TK060.050	O60 Support Profile - 500 mm 連接管		✓	500	1900 gr	7035	1
	TK060.075	O60 Support Profile- 750 mm 連接管		✓	750	2820 gr	7035	1
	TK060.100	O60 Support Profile - 1000 mm 連接管		✓	1000	3770 gr	7035	1
	TK060.125	O60 Support Profile - 1250 mm 連接管		✓	1250	4720 gr	7035	1
	TK060.150	O60 Support Profile - 1500 mm 連接管		✓	1500	5670 gr	7035	1
	TK060.175	O60 Support Profile - 1750 mm 連接管		✓	1750	6620 gr	7035	1
	TK060.200	O60 Support Profile -2000 mm 連接管		✓	2000	7570 gr	7035	1
	TK060.320	Rotatable Panel Coupling 箱體連接件	✓			1260	7035	1
	TK060.321	Rotatable Panel Coupling 底部箱體連接件	✓			1260	7035	1
	TK060.330	TKP2000 Rotatable Panel Coupling TKP2000 箱體連接件	✓			1480	7035	1
	TK060.331	TKP2000 Rotatable Panel Coupling 底部箱體連接件	✓			1495	7035	1
	TK060.400	Rotatable Panel 90° Angle Coupling 90° 箱體連接件	✓			1700	7035 / 7016	1
	TK060.401	Rotatable Panel 90° Angle Coupling 90° 箱體連接件	✓			2610	7035 / 7016	1
	TK060.410	TKP 2000 Rotatable Panel 90° Angle Coupling TKP2000 箱體連接件	✓			1920	7035 / 7016	1
	TK060.411	TKP 2000 Rotatable Panel 90° Angle Coupling TKP2000 90° 箱體連接件	✓			2820	7035 / 7016	1
	TK060.420	90° Angle Piece 90° 轉角		✓		660	7035 / 7016	1
	TK060.500	Rotatable Intermediate Hinge 中間連接件	✓			2075	7035 / 7016	1
	TK060.600	Rotatable Top Mounted 90° Angle Joint 頂座	✓			2110	7035 / 7016	1

TK060 PRODUCT LIST

	Model No	Description	Rotatable Tilting	Fixed	Length mm	Weight gr	Color No Ral No	Package
	TK060.610	Rotatable Top Mounted Vertical Outlet 可旋轉底座	✓			1770	7035 / 7016	1
	TK060.700	Rotatable Wall-Mounted Hinge Horizontal Outlet 水平牆座	✓			2460	7035 / 7016	1
	TK060.710	Rotatable Wall-Mounted Hinge Vertical Outlet 垂直牆座	✓			2220	7035 / 7016	1
	TK060.800	Wall/Socket Mounting Bracket 固定底座		✓		320	7035/ 7016	1
	TK060.810	Warning Lamp Cover M22 警示燈上蓋		✓		150	7016	1
	TK060.811	Warning Lamp Cover M18 警示燈上蓋		✓		160	7016	1
	TK060.820	TK060/045 Support Arm Adaptor 連接管支撐座		✓		420	7035	1
	TK060.830	Rotatable Panel Adaptor Vertical TKP2000 轉換箱體連接件	✓			735	7035	1
	TK060.831	10° Angle Piece 10° 傾斜墊片		✓		100	7035	1
	TK060.835	Panel Tilting Adaptor Moving 可調角度箱體連接件	✓			460	7035 / 7016	1
	TK060.836	Panel Tilting Adaptor 可調角度螢幕連接件	✓			620	7035 / 7016	1
	TK060.843	Tilting Panel Coupling TKP2000 傾斜箱體連接件	✓			1550	7035 / 7016	1
	TK060.844	TKP2000 Tilting Panel Coupling TKP2000 傾斜箱體連接件	✓			1780	7035 / 7016	1
	TK060.845	Rotatable Tilting Panel Coupling 旋轉/傾斜箱體連接件	✓			2170	7035 / 7016	1
	TK060.846	TKP2000 Rotatable Tilting Panel Coupling TKP2000 旋轉/傾斜箱體連接件	✓			2400	7035 / 7016	1

TK040 PRODUCT LIST

	Model No	Description	Rotatable Tilting	Fixed	Length mm	Weight gr	Color No Ral No	Package
	TK040.025	040 Support Profile - 250 mm 連接管		✓	250	520	7035	1
	TK040.050	040 Support Profile - 500 mm 連接管		✓	500	1040	7035	1
	TK040.075	040 Support Profile - 750 mm 連接管		✓	750	1560	7035	1
	TK040.100	040 Support Profile - 1000 mm 連接管		✓	1000	2080	7035	1
	TK040.125	040 Support Profile - 1250 mm 連接管		✓	1250	2600	7035	1
	TK040.150	040 Support Profile - 1500 mm 連接管		✓	1500	3120	7035	1
	TK040.175	040 Support Profile - 1750 mm 連接管		✓	1750	3640	7035	1
	TK040.200	040 Support Profile - 2000 mm 連接管		✓	2000	4160	7035	1
	TK040.320	Rotatable Panel Coupling 箱體連接件	✓			1925	7035	1
	TK040.330	TKP 2000 Rotatable Panel Coupling TKP2000 箱體連接件	✓			1772	7035	1
	TK040.400	Rotatable Panel 90° Angle Coupling 90°箱體連接件	✓			2440	7035 / 7016	1
	TK040.410	TKP 2000 Rotatable Panel 90° Angle Coupling TKP2000 90°箱體連接件	✓			2400	7035 / 7016	1
	TK040.420	90° Angle Piece 90°轉角		✓		518	7035 / 7016	1
	TK040.430	90° Horizontal Angle Piece 90°水平轉角		✓		400	7035 / 7016	1
	TK040.500	Rotatable Intermediate Hinge 中間連接件	✓			3100	7035 / 7016	1
	TK040.600	Rotatable Top Mounted 90° Angle Joint 頂座	✓			3290	7035 / 7016	1
	TK040.610	Rotatable Top Mounted Vertical Outlet 可旋轉底座	✓			2563	7035	1
	TK040.700	Rotatable Wall-Mounted Hinge Horizontal Outlet 水平牆座	✓			3380	7035 / 7016	1
	TK040.710	Rotatable Wall-Mounted Hinge Vertical Outlet 垂直牆座	✓			1920	7035	1
	TK040.800	Wall/Socket Mounting Bracket 固定底座		✓		533	7035 / 7016	1
	TK040.820	90° Wall Mounting 90°固定底座		✓		800	7035 / 7016	1
	TK040.830	Rotatable Wall/Base - Panel Mounting Joint 底部箱體連接件	✓			2463	7035	1
	TK040.840	TKP 2000 Rotatable Wall/Base - Panel Mounting Joint TKP2000 底部箱體連接件	✓			2304	7035	1
	TK040.841	Tilting Panel Coupling 傾斜箱體連接件	✓			2000	7035 / 7016	1
	TK040.842	TKP 2000 Tilting Panel Coupling TKP2000 傾斜箱體連接件	✓			1900	7035 / 7016	1
	TK040.843	Rotatable Tilting Panel Coupling 旋轉/傾斜箱體連接件	✓			3000	7035 / 7016	1
	TK040.844	TKP 2000 Rotatable Tilting Panel Coupling TKP2000 旋轉/傾斜箱體連接件	✓			2900	7035 / 7016	1
	TK040.845	Rotatable Tilting Top Mounted Panel Coupling 旋轉/傾斜箱體連接件	✓			3560	7035 / 7016	1
	TK040.846	TKP 2000 Rotatable Tilting Top Mounted Panel Coupling TKP2000 旋轉/傾斜箱體連接件	✓			3420	7035 / 7016	1

LOAD DIAGRAM

懸臂承重受力圖

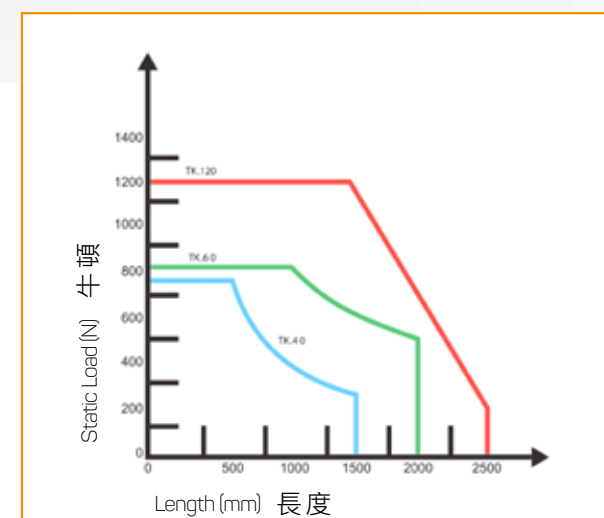

Load Diagram For Various Teknokol Profile Systems

各種TK系列懸臂產品承重受力圖





Support  
**Arm**  
Systems  
懸臂系列



TK120 SERIES PRODUCT LIST

TK120 SERIES PRODUCT LIST



**TK120.025** Support Arm Profile  
連接管

Length (mm)	250
Weight (gr)	1.950
Color/Ral No	7035
Package	1
Package Dimension (mm)	80x130x260



**TK120.331** TKP 2000 Rotatable Panel Coupling  
TKP2000 底部箱體連接件

Weight (gr)	1.550
Color/Ral No	7035
Package	1
Package Dimension (mm)	150x85x140
Diameter (mm)	Ø 130
Movement	Rotatable 310°



**TK120.320** Rotatable Panel Coupling  
箱體連接件

Weight (gr)	1.315
Color/Ral No	7035
Package	1
Package Dimension (mm)	150x65x135
Diameter (mm)	Ø 130
Movement	Rotatable 310°



**TK120.400** Rotatable Panel 90° Angle Coupling  
90° 箱體連接件

Weight (gr)	2.365
Color/Ral No	7035 / 7016
Package	1
Package Dimension (mm)	215x145x170
Diameter (mm)	Ø 130
Movement	Rotatable 310°

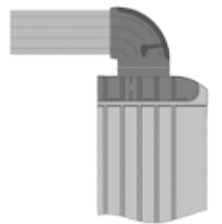

**TK120.321** Rotatable Panel Coupling  
底部箱體連接件

Weight (gr)	1.315
Color/Ral No	7035
Package	1
Package Dimension (mm)	150x65x135
Diameter (mm)	Ø 130
Movement	Rotatable 310°



**TK120.401** Rotatable Panel 90° Angle Coupling  
90° 箱體連接件

Weight (gr)	3.275
Color/Ral No	7035
Package	1
Package Dimension (mm)	215x260x170
Diameter (mm)	Ø 130
Movement	Rotatable 310° / Tilting ± 45°



**TK120.330** TKP 2000 Rotatable Panel Coupling  
TKP2000 箱體連接件

Weight (gr)	1.550
Color/Ral No	7035
Package	1
Package Dimension (mm)	150x85x140
Diameter (mm)	Ø 130
Movement	Rotatable 310°



**TK120.410** TKP2000 Rotatable Panel 90° Angle Coupling  
TKP2000 90°箱體連接件

Weight (gr)	2.575
Color/Ral No	7035 / 7016
Package	1
Package Dimension (mm)	215x140x170
Diameter (mm)	Ø 130
Movement	Rotatable 310°

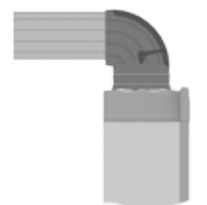



TK120 SERIES PRODUCT LIST

TK120 SERIES PRODUCT LIST



**TK120.411** TKP 2000 Rotatable Panel 90° Angle Coupling  
TKP2000 90°箱體連接件

Weight (gr)	3.510
Color/Ral No	7035
Package	1
Package Dimension (mm)	215x280x170
Diameter (mm)	Ø 130
Movement	Rotatable 310 ° / Tilting ± 45 °



**TK120.610** Rotatable Top Mounted Vertical Outlet  
可旋轉底座

Weight (gr)	4.820
Color/Ral No	7035 / 7016
Package	1
Package Dimension (mm)	220x120x210
Movement	Rotatable 315°

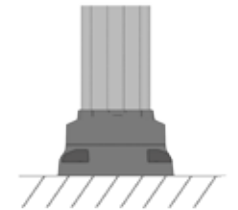

**TK120.420** 90° Angle Piece  
90°轉角

Weight (gr)	1.650
Color/Ral No	7035 / 7016
Package	1
Package Dimension (mm)	165x100x160
Movement	Fixed

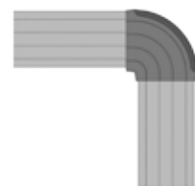

**TK120.700** Rotatable Wall-Mounted Hinge Horizontal Outlet  
水平牆座

Weight (gr)	6.605
Color/Ral No	7035 / 7016
Package	1
Package Dimension (mm)	380x200x210
Movement	Rotatable 315°

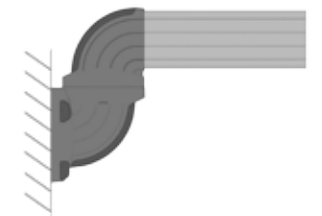

**TK120.500** Rotatable Intermediate Hinge  
中間連接件

Weight (gr)	5.600
Color/Ral No	7035 / 7016
Package	1
Package Dimension (mm)	355x175x175
Movement	Rotatable 315°

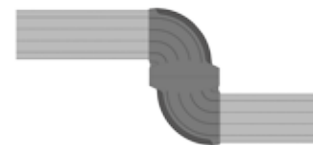

**TK120.710** Rotatable Wall-Mounted Hinge Vertical Outlet  
垂直牆座

Weight (gr)	5.765
Color/Ral No	7035 / 7016
Package	1
Package Dimension (mm)	280x200x205
Movement	Rotatable 315°

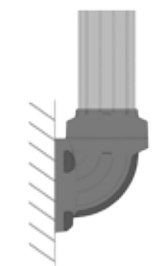

**TK120.600** Rotatable Top Mounted 90° Angle Joint  
頂座

Weight (gr)	5.710
Color/Ral No	7035 / 7016
Package	1
Package Dimension (mm)	210x240x205
Movement	Rotatable 315°

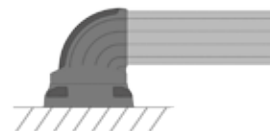

**TK120.800** Wall/Socket Mounting Bracket  
固定底座

Weight (gr)	826
Color/Ral No	7035 / 7016
Package	1
Package Dimension (mm)	220x50x105
Movement	Fixed

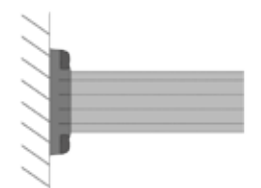

TK120 SERIES PRODUCT LIST

TK120 SERIES PRODUCT LIST



**TK120.810** Warning Lamp Cover  
M22 警示燈上蓋

Weight (gr)	226
Color/Ral No	7016
Package	1
Package Dimension (mm)	205x50x95
Thread Diameter (mm)	M22
Movement	Fixed



**TK120.811** Warning Lamp Cover  
M18 警示燈上蓋

Weight (gr)	236
Color/Ral No	7016
Package	1
Package Dimension (mm)	205x50x95
Thread Diameter (mm)	M18
Movement	Fixed



**TK120.820** TK120/060 Support Arm Adaptor  
連接管支撐座

Weight (gr)	560
Color/Ral No	7035
Package	1
Package Dimension (mm)	135x70x90
Movement	Fixed

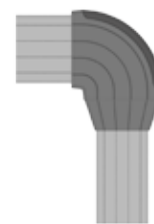

**TK120.843** Tilting Panel Coupling  
傾斜箱體連接件

Weight (gr)	1.600
Color/Ral No	7035 / 7016
Package	1
Package Dimension (mm)	180x160x150
Diameter (mm)	Ø 130
Movement	Tilting ± 45°



**TK120.844** TKP 2000 Tilting Panel Coupling  
TKP2000 傾斜箱體連接件

Weight (gr)	1.830
Color/Ral No	7035 / 7016
Package	1
Package Dimension (mm)	180x170x150
Diameter (mm)	Ø 130
Movement	Tilting ± 45°



**TK120.845** Rotatable Tilting Panel Coupling  
傾斜箱體連接件

Weight (gr)	2.225
Color/Ral No	7035
Package	1
Package Dimension (mm)	180x170x150
Diameter (mm)	Ø 130
Movement	Rotatable 310° / Tilting ± 45°



**TK120.846** TKP 2000 Rotatable Tilting Panel Coupling  
TKP200 旋轉/傾斜箱體連接件

Weight (gr)	2.450
Color/Ral No	7035
Package	1
Package Dimension (mm)	180x190x150
Diameter (mm)	Ø 130
Movement	Rotatable 310° / Tilting ± 45°





TK060 SERIES PRODUCT LIST

TK060 SERIES PRODUCT LIST



**TK060.025** Support Arm Profile  
連接管

Length (mm)	250
Weight (gr)	1.260
Color/Ral No	7035
Package	1
Package Dimension (mm)	90x55x255



**TK060.320** Rotatable Panel Coupling  
箱體連接件

Weight (gr)	1.260
Color/Ral No	7035
Package	1
Package Dimension (mm)	150x60x140
Diameter (mm)	Ø 130
Movement	Rotatable 310°



**TK060.321** Rotatable Panel Coupling  
底部箱體連接件

Weight (gr)	1.260
Color/Ral No	7035
Package	1
Package Dimension (mm)	150x60x140
Diameter (mm)	Ø 130
Movement	Rotatable 310°

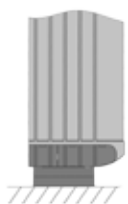

**TK060.330** TKP2000 Rotatable Panel Coupling  
TKP2000 箱體連接件

Weight (gr)	1.500
Color/Ral No	7035
Package	1
Package Dimension (mm)	150x80x140
Diameter (mm)	Ø 130
Movement	Rotatable 310°



**TK060.331** TKP2000 Rotatable Panel Coupling  
TKP2000 底部箱體連接件

Weight (gr)	1.495
Color/Ral No	7035
Package	1
Package Dimension (mm)	150x80x140
Diameter (mm)	Ø 130
Movement	Rotatable 310°



**TK060.400** Rotatable Panel 90° Angle Coupling  
90° 箱體連接件

Weight (gr)	1.777
Color/Ral No	7035 / 7016
Package	1
Package Dimension (mm)	145x150x140
Diameter (mm)	Ø 130
Movement	Rotatable 310°



**TK060.401** Rotatable Panel 90° Angle Coupling  
90° 箱體連接件

Weight (gr)	2.610
Color/Ral No	7035
Package	1
Package Dimension (mm)	180x260x170
Diameter (mm)	Ø 130
Movement	Rotatable 310° / Tilting ± 45°

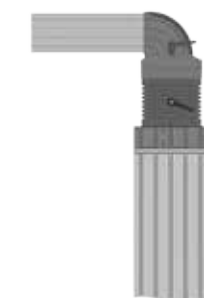

**TK060.410** TKP 2000 Rotatable Panel 90° Angle Coupling  
TKP2000 90° 箱體連接件

Weight (gr)	1.920
Color/Ral No	7035 / 7016
Package	1
Package Dimension (mm)	150x170x140
Diameter (mm)	Ø 130
Movement	Rotatable 310°

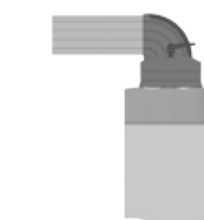

TK060 SERIES PRODUCT LIST

TK060 SERIES PRODUCT LIST



**TK060.411** TKP 2000 Rotatable Panel 90° Angle Coupling  
TKP2000 90° 箱體連接件

Weight (gr)	2.845
Color/Ral No	7035
Package	1
Package Dimension (mm)	180x280x170
Diameter (mm)	Ø 130
Movement	Rotatable 310 ° / Tilting ± 45 °

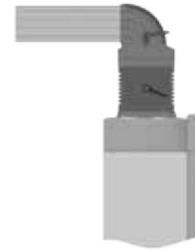

**TK060.420** 90° Angle Piece  
90° 轉角

Weight (gr)	654
Color/Ral No	7035 / 7016
Package	1
Package Dimension (mm)	120x75x115
Movement	Fixed

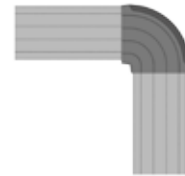

**TK060.500** Rotatable Intermediate Hinge  
中間連接件

Weight (gr)	2.060
Color/Ral No	7035 / 7016
Package	1
Package Dimension (mm)	245x130x125
Movement	Rotatable 315°

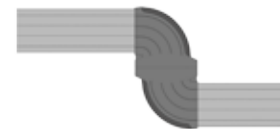

**TK060.600** Rotatable Top Mounted 90° Angle Joint  
頂座

Weight (gr)	2.108
Color/Ral No	7035 / 7016
Package	1
Package Dimension (mm)	155x160x145
Movement	Rotatable 315°

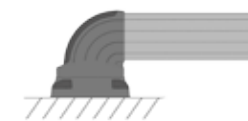

**TK060.610** Rotatable Top Mounted Vertical Outlet  
可旋轉底座

Weight (gr)	1.763
Color/Ral No	7035 / 7016
Package	1
Package Dimension (mm)	155x85x140
Movement	Rotatable 315°

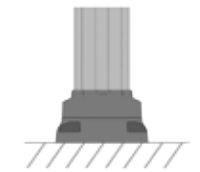

**TK060.700** Rotatable Wall-Mounted Hinge Horizontal Outlet  
水平牆座

Weight (gr)	2.440
Color/Ral No	7035 / 7016
Package	1
Package Dimension (mm)	275x140x145
Movement	Rotatable 315°

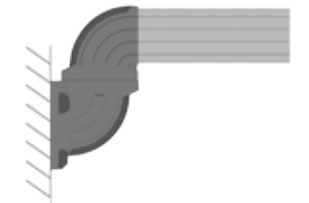

**TK060.710** Rotatable Wall-Mounted Hinge Vertical Outlet  
垂直牆座

Weight (gr)	2.130
Color/Ral No	7035 / 7016
Package	1
Package Dimension (mm)	200x140x145
Movement	Rotatable 315°

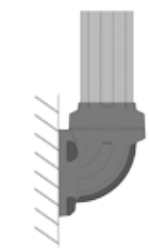

**TK060.800** Wall/Socket Mounting Bracket  
固定底座

Weight (gr)	312
Color/Ral No	7035 / 7016
Package	1
Package Dimension (mm)	160x35x80
Movement	Fixed

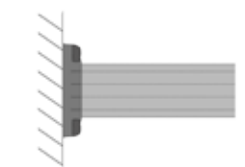



TK060 SERIES PRODUCT LIST

TK060 SERIES PRODUCT LIST

**TK060.810** Warning Lamp Cover  
M22 警示燈上蓋



Weight (gr)	150
Color/Ral No	7016
Package	1
Package Dimension (mm)	130x65x110
Thread Diameter (mm)	M22
Movement	Fixed



**TK060.811** Warning Lamp Cover  
M18 警示燈上蓋



Weight (gr)	236
Color/Ral No	7016
Package	1
Package Dimension (mm)	130x65x110
Thread Diameter (mm)	M18
Movement	Fixed



**TK060.820** TK060/045 Support Arm Adaptor  
連接管支撐座



Weight (gr)	420
Color/Ral No	7035
Package	1
Package Dimension (mm)	120x60x80
Movement	Fixed



**TK060.830** Rotatable Panel Adaptor Vertical  
TK060/TK040 轉換箱體連接件



Weight (gr)	735
Color/Ral No	7035
Package	1
Package Dimension (mm)	130x65x110
Movement	Rotatable 350°



**TK060.831** 10° Angle Piece  
10° 傾斜墊片

Weight (gr)	100
Color/Ral No	7035
Package	1
Package Dimension (mm)	160x35x80
Movement	Fixed



**TK060.835** Panel Tilting Adaptor Moving  
可調角度箱體連接件

Weight (gr)	480
Color/Ral No	7035 / 7016
Package	1
Package Dimension (mm)	155x85x110
Movement	+30° / -40°



**TK060.836** Panel Tilting Adaptor  
可調角度箱體連接件

Weight (gr)	550
Color/Ral No	7035
Package	1
Package Dimension (mm)	180x140x130
Diameter (mm)	
Movement	(30°) / (-40°)



**TK060.843** Tilting Panel Coupling  
傾斜箱體連接件

Weight (gr)	1,550
Color/Ral No	7035 / 7016
Package	1
Package Dimension (mm)	180x150x150
Diameter (mm)	Ø 130
Movement	Tilting ± 45°



TK060 SERIES PRODUCT LIST

**TK060.844** TKP2000 Rotatable Tilting Panel Coupling  
TKP2000 傾斜箱體連接件



Weight (gr)	1780
Color/Ral No	7035 / 7016
Package	1
Package Dimension (mm)	180x170x150
Diameter (mm)	Ø 130
Movement	Tilting ± 45°



**TK060.845** Rotatable Tilting Panel Coupling  
旋轉/傾斜箱體連接件



Weight (gr)	2170
Color/Ral No	7035 / 7016
Package	1
Package Dimension (mm)	180x170x150
Diameter (mm)	Ø 130
Movement	Rotatable 310° / Tilting ± 45°



**TK060.846** TKP2000 Rotatable Tilting Panel Coupling  
TKP 旋轉/傾斜箱體連接件



Weight (gr)	2400
Color/Ral No	7035 / 7016
Package	1
Package Dimension (mm)	180x185x150
Diameter (mm)	Ø 130
Movement	Rotatable 310° / Tilting ± 45°



**JABEZ**  
雅比斯國際有限公司



Special production for customers. Please contact with us for technical details.



TK040 SERIES PRODUCT LIST

TK040 SERIES PRODUCT LIST



**TK040.025** Support Arm Profile  
連接管

Length (mm)	250
Weight (gr)	1.260
Color/Ral No	7035
Package	1
Package Dimension (mm)	90x55x255

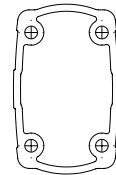

**TK040.410** Rotatable Panel 90° Angel Coupling for TKP2000  
TKP2000 90° 箱體連接件

Weight (gr)	2.400
Color/Ral No	7035 / 7016
Package	1
Package Dimension (mm)	150x220x150
Diameter (mm)	Ø 130
Movement	Rotatable 340°



**TK040.320** Rotatable Panel Coupling  
箱體連接件

Weight (gr)	1.260
Color/Ral No	7035
Package	1
Package Dimension (mm)	150x60x140
Diameter (mm)	Ø 130
Movement	Rotatable 310°



**TK040.420** 90° Angle Piece  
90° 轉角

Weight (gr)	518
Color/Ral No	7035 / 7016
Package	1
Package Dimension (mm)	180x55x110
Movement	Fixed

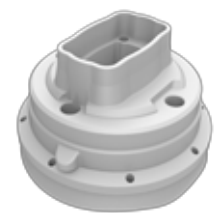

**TK040.330** Rotatable Panel Coupling for TKP2000  
TKP2000 箱體連接件

Weight (gr)	1.500
Color/Ral No	7035
Package	1
Package Dimension (mm)	150x80x140
Diameter (mm)	Ø 130
Movement	Rotatable 310°



**TK040.430** 90° Horizontal Angle Piece  
90° 水平轉角

Weight (gr)	400
Color/Ral No	7035 / 7016
Package	1
Package Dimension (mm)	135x80x85
Movement	Rotatable 315°



**TK040.400** Rotatable Panel 90° Angel Coupling  
90° 箱體連接件

Weight (gr)	1.500
Color/Ral No	7035
Package	1
Package Dimension (mm)	150x80x140
Diameter (mm)	Ø 130
Movement	Rotatable 310°



**TK040.500** Rotatable Intermediate Hinge  
中間連接件

Weight (gr)	3.100
Color/Ral No	7035 / 7016
Package	1
Package Dimension (mm)	365x150x140
Movement	Rotatable 340°



TK040 SERIES PRODUCT LIST

TK040 SERIES PRODUCT LIST



**TK040.600** Rotatable Top Mounted 90° Angle Joint  
頂座

Weight (gr)	3.290
Color/Ral No	7035 / 7016
Package	1
Package Dimension (mm)	190x235x195
Movement	Rotatable 340°

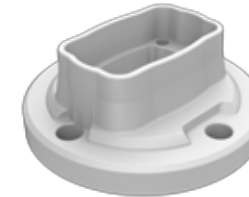
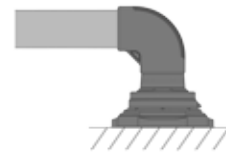

**TK040.800** Wall/Socket Mounting Bracket  
固定底座

Weight (gr)	533
Color/Ral No	7016
Package	1
Package Dimension (mm)	120x50x135
Movement	Fixed

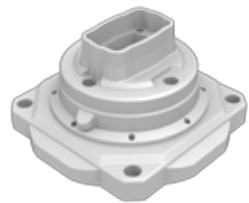
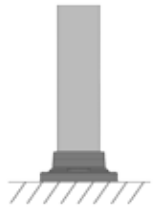

**TK040.610** Rotatable Top Mounted Vertical Outlet  
可旋轉底座

Weight (gr)	2.563
Color/Ral No	7035 / 7016
Package	1
Package Dimension (mm)	195x95x185
Movement	Rotatable 340°

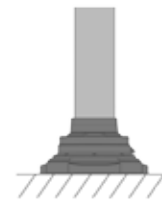

**TK040.820** 90° Wall Mounting  
90° 固定底座

Weight (gr)	800
Color/Ral No	7035 / 7016
Package	1
Package Dimension (mm)	180x55x110
Movement	Fixed

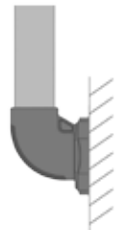

**TK040.700** Rotatable Wall Mounted Hinge Horizontal Outlet  
水平牆座

Weight (gr)	3.380
Color/Ral No	7035 / 7016
Package	1
Package Dimension (mm)	390x160x140
Movement	Rotatable 340°

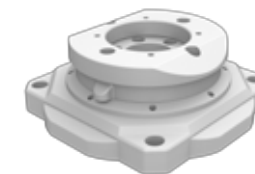
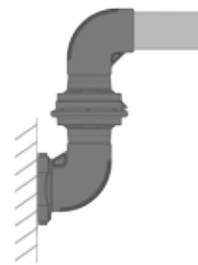

**TK040.830** Rotatable Wall/Base-Panel Mounting Joint  
底部箱體連接件

Weight (gr)	2.463
Color/Ral No	7035
Package	1
Package Dimension (mm)	195x65x185
Diameter (mm)	Ø 136
Movement	Rotatable 340°

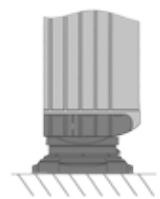

**TK040.710** Rotatable Wall Mounted Hinge Vertical Outlet  
垂直牆座

Weight (gr)	1.920
Color/Ral No	7035 / 7016
Package	1
Package Dimension (mm)	285x135x165
Movement	Rotatable 340°

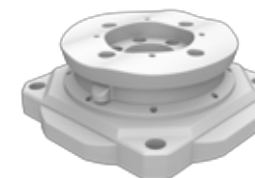

**TK040.840** Rotatable Wall/Base-Panel Mounting Joint for TKP2000  
TKP2000 底部箱體連接件

Weight (gr)	2.304
Color/Ral No	7035
Package	1
Package Dimension (mm)	195x65x185
Diameter (mm)	Ø 136
Movement	Rotatable 340°





TK040 SERIES PRODUCT LIST

TK040 SERIES PRODUCT LIST



**TK040.841** Tilting Panel Coupling  
傾斜箱體連接件

Weight (gr)	2.000
Color/Ral No	7035 / 7016
Package	1
Package Dimension (mm)	180x180x150
Diameter (mm)	Ø 136
Movement	Tilting ± 45°



**TK040.845** Rotatable Tilting Top Mounted Panel Coupling  
旋轉 / 傾斜固定底座

Weight (gr)	3.560
Color/Ral No	7035 / 7016
Package	1
Package Dimension (mm)	200x180x190
Diameter (mm)	Ø 136
Movement	Rotatable 340° / Tilting ± 45°

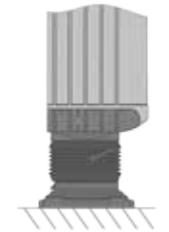

**TK040.842** Tilting Panel Coupling for TKP2000  
TKP2000 傾斜箱體連接件

Weight (gr)	1.900
Color/Ral No	7035 / 7016
Package	1
Package Dimension (mm)	180x 200x150
Diameter (mm)	Ø 136
Movement	Tilting ± 45°



**TK040.846** Rotatable Tilting Top Mounted Panel Coupling for TKP2000  
TKP2000 旋轉 / 傾斜固定底座

Weight (gr)	3.420
Color/Ral No	7035 / 7016
Package	1
Package Dimension (mm)	200x180x190
Diameter (mm)	Ø 136
Movement	Rotatable 340° / Tilting ± 45°



**TK040.843** Rotatable Tilting Panel Coupling  
旋轉 / 傾斜箱體連接件

Weight (gr)	3.000
Color/Ral No	7035 / 7016
Package	1
Package Dimension (mm)	180x200x150
Diameter (mm)	Ø 136
Movement	Rotatable 340° / Tilting ± 45°



**TK040.844** Rotatable Tilting Panel Coupling for TKP2000

Weight (gr)	2.900
Color/Ral No	7035 / 7016
Package	1
Package Dimension (mm)	180x200x150
Diameter (mm)	Ø 136
Movement	Rotatable 340° / Tilting ± 45°



TK045 SERIES PRODUCT LIST

TK045 SERIES PRODUCT LIST

NEW



**TK045.025** Support Arm Profile  
連接管

Length (mm)	250
Weight (gr)	550
Color/Ral No	7035
Package	1
Package Dimension (mm)	50x75x255



NEW



**TK045.600** Rotatable Top Mounted 90° Angle Joint  
頂座

Weight (gr)	1.750
Color/Ral No	7035
Package	1
Package Dimension (mm)	120x130x120
Diameter (mm)	Ø 130
Movement	Rotatable 310°

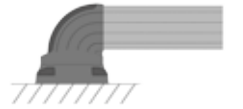

NEW



**TK045.400** Rotatable Panel 90° Angle Coupling  
90° 箱體連接件

Weight (gr)	1300
Color/Ral No	7035
Package	1
Package Dimension (mm)	120x130x120
Diameter (mm)	Ø 130
Movement	Dönüş 310°



NEW



**TK045.700** Rotatable Wall-Mounted Hinge Horizontal Outlet  
水平牆座

Weight (gr)	1.950
Color/Ral No	7035
Package	1
Package Dimension (mm)	120x220x120
Diameter (mm)	Ø 130
Movement	Rotatable 310°

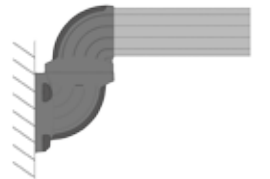

NEW



**TK045.420** 90° Angle Piece  
90° 轉角

Weight (gr)	480
Color/Ral No	7035
Package	1
Package Dimension (mm)	95x95x60
Movement	Fixed



NEW



**TK045.800** Wall/Socket Mounting Bracket  
固定底座

Weight (gr)	220
Color/Ral No	7035
Package	1
Package Dimension (mm)	60x120x25
Movement	Fixed

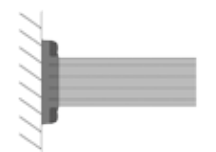

NEW



**TK045.500** Rotatable Intermediate Hinge  
中間連接件

Weight (gr)	1.800
Color/Ral No	7035
Package	1
Package Dimension (mm)	120x220x120
Diameter (mm)	Ø 130
Movement	Rotatable 310°



NEW



**TK045.830** Rotatable Panel Adaptor Vertical  
箱體連接件

Weight (gr)	570
Color/Ral No	7035
Package	1
Package Dimension (mm)	130x65x110
Diameter (mm)	Ø 130
Movement	Rotatable 310°



APPLICATION SAMPLES 應用範例

APPLICATION SAMPLES 應用範例

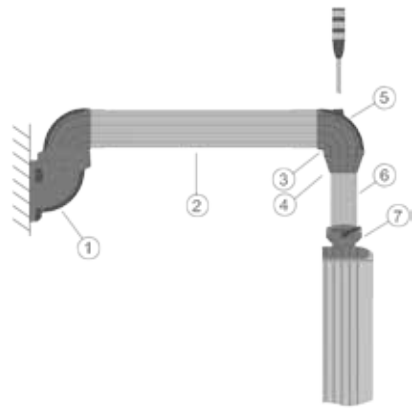

<b>A</b>	1 Rotatable wall mounted hinge horizontal outlet	TK120.700
	2 Support arm profile - 750mm	TK120.075
	3 90° Angle piece	TK120.420
	4 Support arm adaptor 120/060	TK120.820
	5 Warning lamp cover	TK120.810
	6 Support arm profile - 250mm	TK060.025
	7 Rotatable panel adaptor	TK060.830

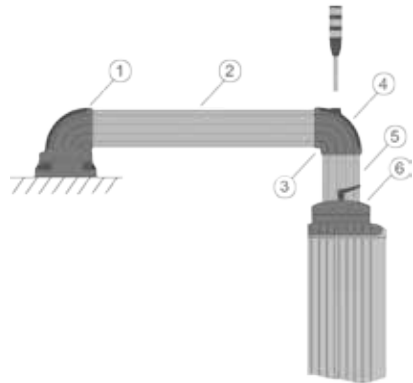

<b>B</b>	1 Rotatable top mounted 90° angle joint	TK120.600
	2 Support arm profile - 750mm	TK120.075
	3 90° Angle piece	TK120.420
	4 Warning lamp cover	TK120.810
	5 Support arm profile - 250mm	TK120.025
	6 Rotatable panel coupling	TK120.320

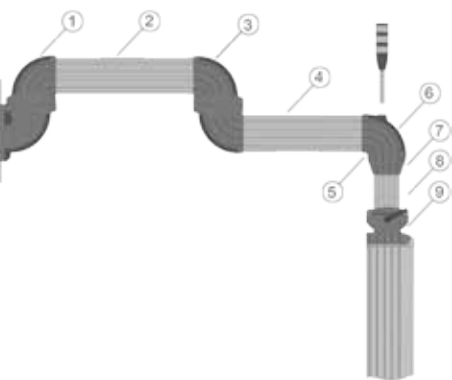

<b>C</b>	1 Rotatable wall mounted hinge horizontal outlet	TK120.700
	2 Support arm profile - 500mm	TK120.050
	3 Rotatable intermediate hinge	TK120.500
	4 Support arm profile - 500mm	TK120.050
	5 90° Angle piece	TK120.420
	6 Warning lamp cover	TK120.810
	7 Support arm adaptor 120/060	TK120.820
	8 Support arm profile - 250mm	TK060.025
	9 Rotatable panel adaptor	TK060.830

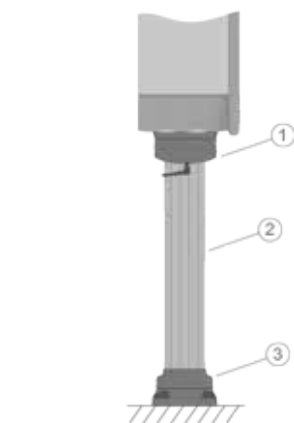

<b>D</b>	1 Rotatable panel coupling	TK120.320
	2 Support arm profile - 750mm	TK120.075
	3 Rotatable top mounted vertical outlet	TK120.610

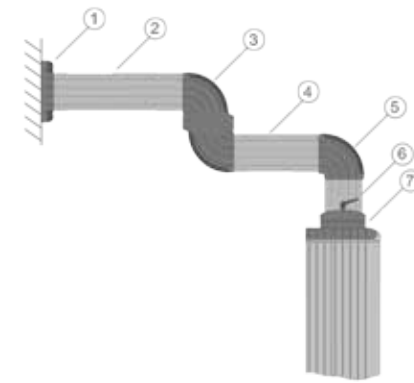

<b>E</b>	1 Wall/Socket mounting bracket	TK120.800
	2 Support arm profile - 500mm	TK120.050
	3 Rotatable intermediate hinge	TK120.500
	4 Support arm profile - 500mm	TK120.050
	5 90° Angle piece	TK120.420
	6 Support arm profile - 250mm	TK120.025
	7 Rotatable panel coupling	TK120.320

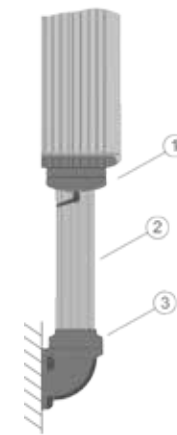

<b>F</b>	1 Rotatable panel coupling	TK120.320
	2 Support arm profile - 750mm	TK120.075
	3 Rotatable wall mounted hinge vertical outlet	TK120.710

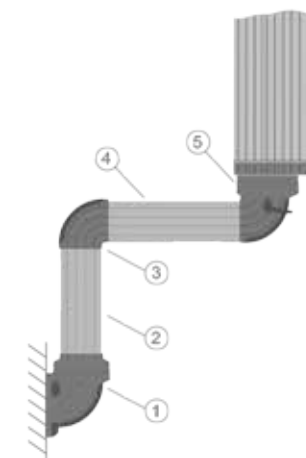

<b>G</b>	1 Rotatable wall mounted hinge vertical outlet	TK120.710
	2 Support arm profile - 500mm	TK120.050
	3 90° Angle piece	TK120.420
	4 Support arm profile - 500mm	TK120.050
	5 Rotatable panel 90° angle coupling	TK120.400

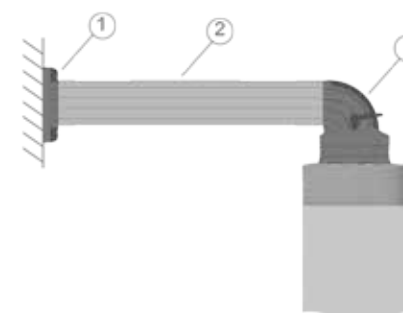

<b>H</b>	1 Wall/Socket mounting bracket	TK120.800
	2 Support arm profile - 750mm	TK120.075
	3 Rotatable panel 90° angle coupling	TK120.420



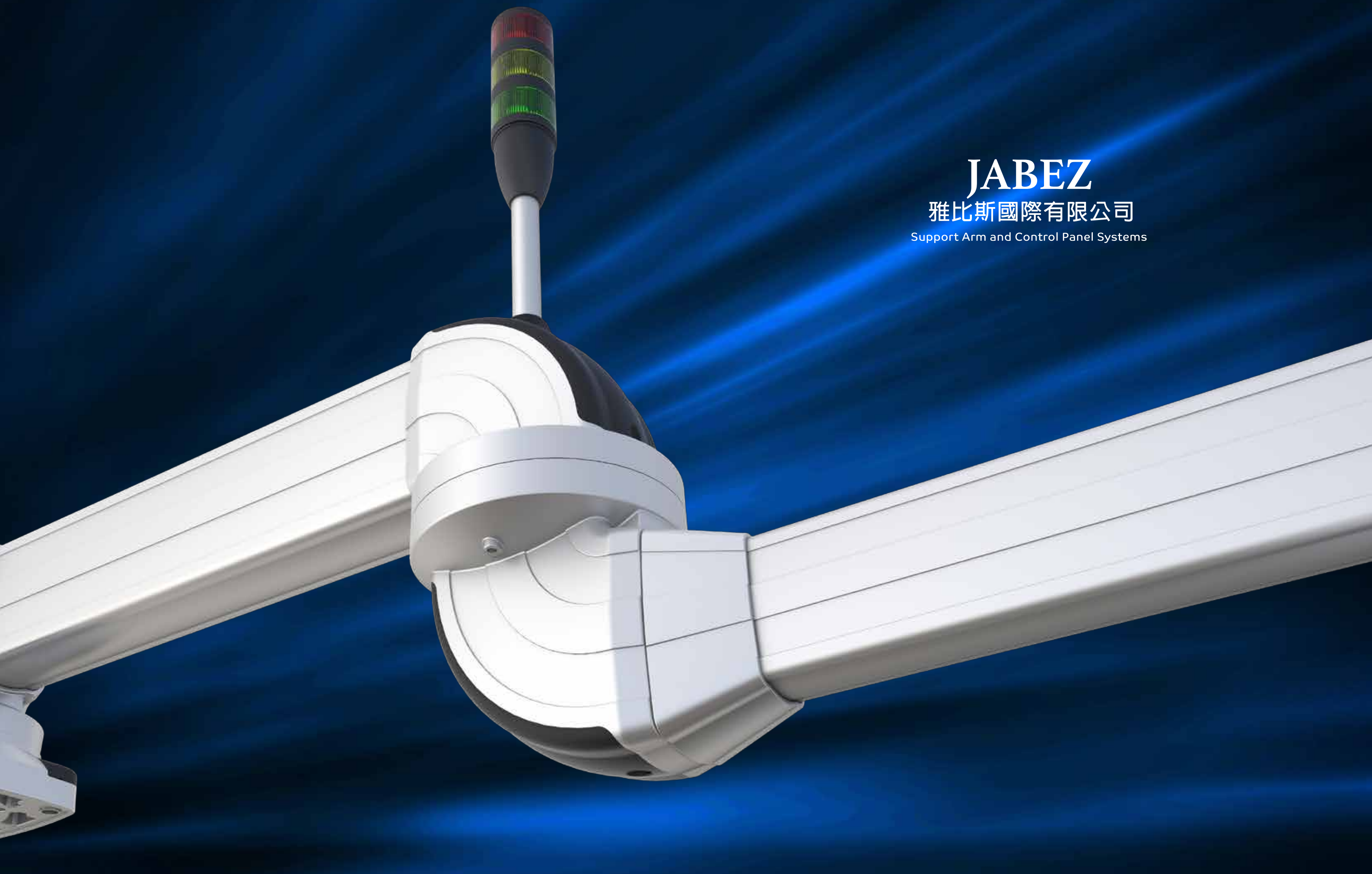

**JABEZ**

雅比斯國際有限公司

Support Arm and Control Panel Systems

# Panel Systems

面板系列





ECO 60 SERIES PANEL

ECO 60 SERIES PANEL

ECO 6000.0000



Installation Area 安裝尺寸(範圍)			Back Area 背部安裝		Installation Depth 安裝深度		Support Arm No TK 連接管型號		Order No 訂貨號
Width (mm)	Height (mm)	Depth (mm)	Hinge 後開門型式	Screw 固定背板 型式	H profil profile instal- lation platform 側面安裝平臺	Installation Deep (mm) 安裝深度	130mm Ø	118x65.5mm □	Eco
300	300	60	Yes	-	-	60	-	Yes	6000-0004
300	300	60	-	Yes	-	60	-	Yes	6000-0005
300	400	60	Yes	-	-	60	-	Yes	6000-0006
300	400	60	-	Yes	-	60	-	Yes	6000-0007
400	400	60	Yes	-	-	60	-	Yes	6000-0008
400	400	60	-	Yes	-	60	-	Yes	6000-0009
400	500	60	Yes	-	-	60	-	Yes	6000-0010
400	500	60	-	Yes	-	60	-	Yes	6000-0011
500	500	60	Yes	-	-	60	-	Yes	6000-0012
500	500	60	-	Yes	-	60	-	Yes	6000-0013
500	600	60	Yes	-	-	60	-	Yes	6000-0014
500	600	60	-	Yes	-	60	-	Yes	6000-0015
600	600	60	Yes	-	-	60	-	Yes	6000-0016
600	600	60	-	Yes	-	60	-	Yes	6000-0017

\*\* Please contact with us for non-standart panel sizes

ECO 6000.0200



Installation Area 安裝尺寸(範圍)			Back Area 背部安裝		Installation Depth 安裝深度		Support Arm No TK 連接管型號		Order No 訂貨號
Width (mm)	Height (mm)	Depth (mm)	Hinge 後開門型式	Screw 固定背板 型式	H profil profile instal- lation platform 側面安裝平臺	Installation Deep (mm) 安裝深度	130mm Ø	118x65.5mm □	Eco
300	300	60	Yes	-	-	60	-	Yes	6000-0204
300	300	60	-	Yes	-	60	-	Yes	6000-0205
300	400	60	Yes	-	-	60	-	Yes	6000-0206
300	400	60	-	Yes	-	60	-	Yes	6000-0207
400	400	60	Yes	-	-	60	-	Yes	6000-0208
400	400	60	-	Yes	-	60	-	Yes	6000-0209
400	500	60	Yes	-	-	60	-	Yes	6000-0210
400	500	60	-	Yes	-	60	-	Yes	6000-0211
500	500	60	Yes	-	-	60	-	Yes	6000-0212
500	500	60	-	Yes	-	60	-	Yes	6000-0213
500	600	60	Yes	-	-	60	-	Yes	6000-0214
500	600	60	-	Yes	-	60	-	Yes	6000-0215
600	600	60	Yes	-	-	60	-	Yes	6000-0216
600	600	60	-	Yes	-	60	-	Yes	6000-0217

\*\* Please contact with us for non-standart panel sizes

ECO 6000.0100



Installation Area 安裝尺寸(範圍)			Back Area 背部安裝		Installation Depth 安裝深度		Support Arm No TK 連接管型號		Order No 訂貨號
Width (mm)	Height (mm)	Depth (mm)	Hinge 後開門型式	Screw 固定背板 型式	H profil profile instal- lation platform 側面安裝平臺	Installation Deep (mm) 安裝深度	130mm Ø	118x65.5mm □	Eco
300	300	60	Yes	-	-	60	-	Yes	6000-0104
300	300	60	-	Yes	-	60	-	Yes	6000-0105
300	400	60	Yes	-	-	60	-	Yes	6000-0106
300	400	60	-	Yes	-	60	-	Yes	6000-0107
400	400	60	Yes	-	-	60	-	Yes	6000-0108
400	400	60	-	Yes	-	60	-	Yes	6000-0109
400	500	60	Yes	-	-	60	-	Yes	6000-0110
400	500	60	-	Yes	-	60	-	Yes	6000-0111
500	500	60	Yes	-	-	60	-	Yes	6000-0112
500	500	60	-	Yes	-	60	-	Yes	6000-0113
500	600	60	Yes	-	-	60	-	Yes	6000-0114
500	600	60	-	Yes	-	60	-	Yes	6000-0115
600	600	60	Yes	-	-	60	-	Yes	6000-0116
600	600	60	-	Yes	-	60	-	Yes	6000-0117

\*\* Please contact with us for non-standart panel sizes

ECO 6000.6000



Installation Area 安裝尺寸(範圍)			Back Area 背部安裝		Installation Depth 安裝深度		Support Arm No TK 連接管型號		Order No 訂貨號
Width (mm)	Height (mm)	Depth (mm)	Hinge 後開門型式	Screw 固定背板 型式	H profil profile instal- lation platform 側面安裝平臺	Installation Deep (mm) 安裝深度	130mm Ø	118x65.5mm □	Eco
300	300	60	Yes	-	-	60	-	Yes	6000-6004
300	300	60	-	Yes	-	60	-	Yes	6000-6005
300	400	60	Yes	-	-	60	-	Yes	6000-6006
300	400	60	-	Yes	-	60	-	Yes	6000-6007
400	400	60	Yes	-	-	60	-	Yes	6000-6008
400	400	60	-	Yes	-	60	-	Yes	6000-6009
400	500	60	Yes	-	-	60	-	Yes	6000-6010
400	500	60	-	Yes	-	60	-	Yes	6000-6011
500	500	60	Yes	-	-	60	-	Yes	6000-6012
500	500	60	-	Yes	-	60	-	Yes	6000-6013
500	600	60	Yes	-	-	60	-	Yes	6000-6014
500	600	60	-	Yes	-	60	-	Yes	6000-6015
600	600	60	Yes	-	-	60	-	Yes	6000-6016
600	600	60	-	Yes	-	60	-	Yes	6000-6017

\*Please contact with us for keyboard dimensions



ECO 60 SERIES PANEL

ECO 60 SERIES PANEL

ECO 6090.0000



Installation Area 安裝尺寸(範圍)			Back Area 背部安裝		Installation Depth 安裝深度		Support Arm No TK 連接管型號		Order No 訂貨號
Width (mm)	Height (mm)	Depth (mm)	Hinge 後開門型式	Screw 固定背板 型式	H profil profile instal- lation platform 側面安裝平臺	Installation Deep (mm) 安裝深度	130mm Ø	118x65.5mm □	Eco
300	300	150	Yes	-	Yes	127	-	Yes	6090-0004
300	300	150	-	Yes	-	150	-	Yes	6090-0005
300	400	150	Yes	-	Yes	127	-	Yes	6090-0006
300	400	150	-	Yes	-	150	-	Yes	6090-0007
400	400	150	Yes	-	Yes	127	-	Yes	6090-0008
400	400	150	-	Yes	-	150	-	Yes	6090-0009
400	500	150	Yes	-	Yes	127	-	Yes	6090-0010
400	500	150	-	Yes	-	150	-	Yes	6090-0011
500	500	150	Yes	-	Yes	127	-	Yes	6090-0012
500	500	150	-	Yes	-	150	-	Yes	6090-0013
500	600	150	Yes	-	Yes	127	-	Yes	6090-0014
500	600	150	-	Yes	-	150	-	Yes	6090-0015
600	600	150	Yes	-	Yes	127	-	Yes	6090-0016
600	600	150	-	Yes	-	150	-	Yes	6090-0017

\*\* Please contact with us for non-standart panel sizes

ECO 6090.0200



Installation Area 安裝尺寸(範圍)			Back Area 背部安裝		Installation Depth 安裝深度		Support Arm No TK 連接管型號		Order No 訂貨號
Width (mm)	Height (mm)	Depth (mm)	Hinge 後開門型式	Screw 固定背板 型式	H profil profile instal- lation platform 側面安裝平臺	Installation Deep (mm) 安裝深度	130mm Ø	118x65.5mm □	Eco
300	300	150	Yes	-	Yes	127	-	Yes	6090-0204
300	300	150	-	Yes	-	150	-	Yes	6090-0205
300	400	150	Yes	-	Yes	127	-	Yes	6090-0206
300	400	150	-	Yes	-	150	-	Yes	6090-0207
400	400	150	Yes	-	Yes	127	-	Yes	6090-0208
400	400	150	-	Yes	-	150	-	Yes	6090-0209
400	500	150	Yes	-	Yes	127	-	Yes	6090-0210
400	500	150	-	Yes	-	150	-	Yes	6090-0211
500	500	150	Yes	-	Yes	127	-	Yes	6090-0212
500	500	150	-	Yes	-	150	-	Yes	6090-0213
500	600	150	Yes	-	Yes	127	-	Yes	6090-0214
500	600	150	-	Yes	-	150	-	Yes	6090-0215
600	600	150	Yes	-	Yes	127	-	Yes	6090-0216
600	600	150	-	Yes	-	150	-	Yes	6090-0217

\*\* Please contact with us for non-standart panel sizes

ECO 6090.0100



Installation Area 安裝尺寸(範圍)			Back Area 背部安裝		Installation Depth 安裝深度		Support Arm No TK 連接管型號		Order No 訂貨號
Width (mm)	Height (mm)	Depth (mm)	Hinge 後開門型式	Screw 固定背板 型式	H profil profile instal- lation platform 側面安裝平臺	Installation Deep (mm) 安裝深度	130mm Ø	118x65.5mm □	Eco
300	300	150	Yes	-	Yes	127	-	Yes	6090-0104
300	300	150	-	Yes	-	150	-	Yes	6090-0105
300	400	150	Yes	-	Yes	127	-	Yes	6090-0106
300	400	150	-	Yes	-	150	-	Yes	6090-0107
400	400	150	Yes	-	Yes	127	-	Yes	6090-0108
400	400	150	-	Yes	-	150	-	Yes	6090-0109
400	500	150	Yes	-	Yes	127	-	Yes	6090-0110
400	500	150	-	Yes	-	150	-	Yes	6090-0111
500	500	150	Yes	-	Yes	127	-	Yes	6090-0112
500	500	150	-	Yes	-	150	-	Yes	6090-0113
500	600	150	Yes	-	Yes	127	-	Yes	6090-0114
500	600	150	-	Yes	-	150	-	Yes	6090-0115
600	600	150	Yes	-	Yes	127	-	Yes	6090-0116
600	600	150	-	Yes	-	150	-	Yes	6090-0117

\*\* Please contact with us for non-standart panel sizes

ECO 6090.6000



Installation Area 安裝尺寸(範圍)			Back Area 背部安裝		Installation Depth 安裝深度		Support Arm No TK 連接管型號		Order No 訂貨號
Width (mm)	Height (mm)	Depth (mm)	Hinge 後開門型式	Screw 固定背板 型式	H profil profile instal- lation platform 側面安裝平臺	Installation Deep (mm) 安裝深度	130mm Ø	118x65.5mm □	Eco
300	300	150	Yes	-	Yes	127	-	Yes	6090-6004
300	300	150	-	Yes	-	150	-	Yes	6090-6005
300	400	150	Yes	-	Yes	127	-	Yes	6090-6006
300	400	150	-	Yes	-	150	-	Yes	6090-6007
400	400	150	Yes	-	Yes	127	-	Yes	6090-6008
400	400	150	-	Yes	-	150	-	Yes	6090-6009
400	500	150	Yes	-	Yes	127	-	Yes	6090-6010
400	500	150	-	Yes	-	150	-	Yes	6090-6011
500	500	150	Yes	-	Yes	127	-	Yes	6090-6012
500	500	150	-	Yes	-	150	-	Yes	6090-6013
500	600	150	Yes	-	Yes	127	-	Yes	6090-6014
500	600	150	-	Yes	-	150	-	Yes	6090-6015
600	600	150	Yes	-	Yes	127	-	Yes	6090-6016
600	600	150	-	Yes	-	150	-	Yes	6090-6017

\*Please contact with us for keyboard dimensions

ECO 60 SERIES PANEL

ECO 60 SERIES PANEL

ECO 6091.0000



Installation Area 安裝尺寸(範圍)			Back Area 背部安裝		Installation Depth 安裝深度		Support Arm No TK 連接管型號		Order No 訂貨號
Width (mm)	Height (mm)	Depth (mm)	Hinge 後開門型式	Screw 固定背板 型式	H profil profile instal- lation platform 側面安裝平臺	Installation Deep (mm) 安裝深度	130mm Ø	118x65.5mm □	Eco
300	300	150	Yes	-	Yes	127	-	Yes	6091-0004
300	300	150	-	Yes	-	150	-	Yes	6091-0005
300	400	150	Yes	-	Yes	127	-	Yes	6091-0006
300	400	150	-	Yes	-	150	-	Yes	6091-0007
400	400	150	Yes	-	Yes	127	-	Yes	6091-0008
400	400	150	-	Yes	-	150	-	Yes	6091-0009
400	500	150	Yes	-	Yes	127	-	Yes	6091-0010
400	500	150	-	Yes	-	150	-	Yes	6091-0011
500	500	150	Yes	-	Yes	127	-	Yes	6091-0012
500	500	150	-	Yes	-	150	-	Yes	6091-0013
500	600	150	Yes	-	Yes	127	-	Yes	6091-0014
500	600	150	-	Yes	-	150	-	Yes	6091-0015
600	600	150	Yes	-	Yes	127	-	Yes	6091-0016
600	600	150	-	Yes	-	150	-	Yes	6091-0017

\*\* Please contact with us for non-standart panel sizes

ECO 6091.0200



Installation Area 安裝尺寸(範圍)			Back Area 背部安裝		Installation Depth 安裝深度		Support Arm No TK 連接管型號		Order No 訂貨號
Width (mm)	Height (mm)	Depth (mm)	Hinge 後開門型式	Screw 固定背板 型式	H profil profile instal- lation platform 側面安裝平臺	Installation Deep (mm) 安裝深度	130mm Ø	118x65.5mm □	Eco
300	300	150	Yes	-	Yes	127	-	Yes	6091-0204
300	300	150	-	Yes	-	150	-	Yes	6091-0205
300	400	150	Yes	-	Yes	127	-	Yes	6091-0206
300	400	150	-	Yes	-	150	-	Yes	6091-0207
400	400	150	Yes	-	Yes	127	-	Yes	6091-0208
400	400	150	-	Yes	-	150	-	Yes	6091-0209
400	500	150	Yes	-	Yes	127	-	Yes	6091-0210
400	500	150	-	Yes	-	150	-	Yes	6091-0211
500	500	150	Yes	-	Yes	127	-	Yes	6091-0212
500	500	150	-	Yes	-	150	-	Yes	6091-0213
500	600	150	Yes	-	Yes	127	-	Yes	6091-0214
500	600	150	-	Yes	-	150	-	Yes	6091-0215
600	600	150	Yes	-	Yes	127	-	Yes	6091-0216
600	600	150	-	Yes	-	150	-	Yes	6091-0217

\*\* Please contact with us for non-standart panel sizes

ECO 6091.0100



Installation Area 安裝尺寸(範圍)			Back Area 背部安裝		Installation Depth 安裝深度		Support Arm No TK 連接管型號		Order No 訂貨號
Width (mm)	Height (mm)	Depth (mm)	Hinge 後開門型式	Screw 固定背板 型式	H profil profile instal- lation platform 側面安裝平臺	Installation Deep (mm) 安裝深度	130mm Ø	118x65.5mm □	Eco
300	300	150	Yes	-	Yes	127	-	Yes	6091-0104
300	300	150	-	Yes	-	150	-	Yes	6091-0105
300	400	150	Yes	-	Yes	127	-	Yes	6091-0106
300	400	150	-	Yes	-	150	-	Yes	6091-0107
400	400	150	Yes	-	Yes	127	-	Yes	6091-0108
400	400	150	-	Yes	-	150	-	Yes	6091-0109
400	500	150	Yes	-	Yes	127	-	Yes	6091-0110
400	500	150	-	Yes	-	150	-	Yes	6091-0111
500	500	150	Yes	-	Yes	127	-	Yes	6091-0112
500	500	150	-	Yes	-	150	-	Yes	6091-0113
500	600	150	Yes	-	Yes	127	-	Yes	6091-0114
500	600	150	-	Yes	-	150	-	Yes	6091-0115
600	600	150	Yes	-	Yes	127	-	Yes	6091-0116
600	600	150	-	Yes	-	150	-	Yes	6091-0117

\*\* Please contact with us for non-standart panel sizes

ECO 6091.6000



Installation Area 安裝尺寸(範圍)			Back Area 背部安裝		Installation Depth 安裝深度		Support Arm No TK 連接管型號		Order No 訂貨號
Width (mm)	Height (mm)	Depth (mm)	Hinge 後開門型式	Screw 固定背板 型式	H profil profile instal- lation platform 側面安裝平臺	Installation Deep (mm) 安裝深度	130mm Ø	118x65.5mm □	Eco
300	300	150	Yes	-	Yes	127	-	Yes	6091-0604
300	300	150	-	Yes	-	150	-	Yes	6091-0605
300	400	150	Yes	-	Yes	127	-	Yes	6091-0606
300	400	150	-	Yes	-	150	-	Yes	6091-0607
400	400	150	Yes	-	Yes	127	-	Yes	6091-0608
400	400	150	-	Yes	-	150	-	Yes	6091-0609
400	500	150	Yes	-	Yes	127	-	Yes	6091-0610
400	500	150	-	Yes	-	150	-	Yes	6091-0611
500	500	150	Yes	-	Yes	127	-	Yes	6091-0612
500	500	150	-	Yes	-	150	-	Yes	6091-0613
500	600	150	Yes	-	Yes	127	-	Yes	6091-0614
500	600	150	-	Yes	-	150	-	Yes	6091-0615
600	600	150	Yes	-	Yes	127	-	Yes	6091-0616
600	600	150	-	Yes	-	150	-	Yes	6091-0617

\*Please contact with us for keyboard dimensions

ECO 90 SERIES PANEL

ECO 90 SERIES PANEL

ECO 9000.0000



Installation Area 安裝尺寸(範圍)			Back Area 背部安裝		Installation Depth 安裝深度		Support Arm No TK 連接管型號		Order No 訂貨號
Width (mm)	Height (mm)	Depth (mm)	Hinge 後開門型式	Screw 固定背板 型式	H profil profile instal- lation platform 側面安裝平臺	Installation Deep (mm) 安裝深度	130mm Ø	118x65.5mm □	Eco
300	300	90	Yes	-	Yes	67	-	Yes	9000-0004
300	300	90	-	Yes	-	90	-	Yes	9000-0005
300	400	90	Yes	-	Yes	67	-	Yes	9000-0006
300	400	90	-	Yes	-	90	-	Yes	9000-0007
400	400	90	Yes	-	Yes	67	-	Yes	9000-0008
400	400	90	-	Yes	-	90	-	Yes	9000-0009
400	500	90	Yes	-	Yes	67	-	Yes	9000-0010
400	500	90	-	Yes	-	90	-	Yes	9000-0011
500	500	90	Yes	-	Yes	67	-	Yes	9000-0012
500	500	90	-	Yes	-	90	-	Yes	9000-0013
500	600	90	Yes	-	Yes	67	-	Yes	9000-0014
500	600	90	-	Yes	-	90	-	Yes	9000-0015
600	600	90	Yes	-	Yes	67	-	Yes	9000-0016
600	600	90	-	Yes	-	90	-	Yes	9000-0017

\*\* Please contact with us for non-standart panel sizes

ECO 9000.0200



Installation Area 安裝尺寸(範圍)			Back Area 背部安裝		Installation Depth 安裝深度		Support Arm No TK 連接管型號		Order No 訂貨號
Width (mm)	Height (mm)	Depth (mm)	Hinge 後開門型式	Screw 固定背板 型式	H profil profile instal- lation platform 側面安裝平臺	Installation Deep (mm) 安裝深度	130mm Ø	118x65.5mm □	Eco
300	300	90	Yes	-	Yes	67	-	Yes	9000-0204
300	300	90	-	Yes	-	90	-	Yes	9000-0205
300	400	90	Yes	-	Yes	67	-	Yes	9000-0206
300	400	90	-	Yes	-	90	-	Yes	9000-0207
400	400	90	Yes	-	Yes	67	-	Yes	9000-0208
400	400	90	-	Yes	-	90	-	Yes	9000-0209
400	500	90	Yes	-	Yes	67	-	Yes	9000-0210
400	500	90	-	Yes	-	90	-	Yes	9000-0211
500	500	90	Yes	-	Yes	67	-	Yes	9000-0212
500	500	90	-	Yes	-	90	-	Yes	9000-0213
500	600	90	Yes	-	Yes	67	-	Yes	9000-0214
500	600	90	-	Yes	-	90	-	Yes	9000-0215
600	600	90	Yes	-	Yes	67	-	Yes	9000-0216
600	600	90	-	Yes	-	90	-	Yes	9000-0217

\*\* Please contact with us for non-standart panel sizes

ECO 9000.0100



Installation Area 安裝尺寸(範圍)			Back Area 背部安裝		Installation Depth 安裝深度		Support Arm No TK 連接管型號		Order No 訂貨號
Width (mm)	Height (mm)	Depth (mm)	Hinge 後開門型式	Screw 固定背板 型式	H profil profile instal- lation platform 側面安裝平臺	Installation Deep (mm) 安裝深度	130mm Ø	118x65.5mm □	Eco
300	300	90	Yes	-	Yes	67	-	Yes	9000-0104
300	300	90	-	Yes	-	90	-	Yes	9000-0105
300	400	90	Yes	-	Yes	67	-	Yes	9000-0106
300	400	90	-	Yes	-	90	-	Yes	9000-0107
400	400	90	Yes	-	Yes	67	-	Yes	9000-0108
400	400	90	-	Yes	-	90	-	Yes	9000-0109
400	500	90	Yes	-	Yes	67	-	Yes	9000-0110
400	500	90	-	Yes	-	90	-	Yes	9000-0111
500	500	90	Yes	-	Yes	67	-	Yes	9000-0112
500	500	90	-	Yes	-	90	-	Yes	9000-0113
500	600	90	Yes	-	Yes	67	-	Yes	9000-0114
500	600	90	-	Yes	-	90	-	Yes	9000-0115
600	600	90	Yes	-	Yes	67	-	Yes	9000-0116
600	600	90	-	Yes	-	90	-	Yes	9000-0117

\*\* Please contact with us for non-standart panel sizes

ECO 9000.6000



Installation Area 安裝尺寸(範圍)			Back Area 背部安裝		Installation Depth 安裝深度		Support Arm No TK 連接管型號		Order No 訂貨號
Width (mm)	Height (mm)	Depth (mm)	Hinge 後開門型式	Screw 固定背板 型式	H profil profile instal- lation platform 側面安裝平臺	Installation Deep (mm) 安裝深度	130mm Ø	118x65.5mm □	Eco
300	300	90	Yes	-	Yes	67	-	Yes	9000-6004
300	300	90	-	Yes	-	90	-	Yes	9000-6005
300	400	90	Yes	-	Yes	67	-	Yes	9000-6006
300	400	90	-	Yes	-	90	-	Yes	9000-6007
400	400	90	Yes	-	Yes	67	-	Yes	9000-6008
400	400	90	-	Yes	-	90	-	Yes	9000-6009
400	500	90	Yes	-	Yes	67	-	Yes	9000-6010
400	500	90	-	Yes	-	90	-	Yes	9000-6011
500	500	90	Yes	-	Yes	67	-	Yes	9000-6012
500	500	90	-	Yes	-	90	-	Yes	9000-6013
500	600	90	Yes	-	Yes	67	-	Yes	9000-6014
500	600	90	-	Yes	-	90	-	Yes	9000-6015
600	600	90	Yes	-	Yes	67	-	Yes	9000-6016
600	600	90	-	Yes	-	90	-	Yes	9000-6017

\*Please contact with us for keyboard dimensions



ECO 90 SERIES PANEL

ECO 90 SERIES PANEL

ECO 9090.0000



Installation Area 安裝尺寸(範圍)			Back Area 背部安裝		Installation Depth 安裝深度		Support Arm No TK 連接管型號		Order No 訂貨號
Width (mm)	Height (mm)	Depth (mm)	Hinge 後開門型式	Screw 固定背板 型式	H profil profile instal- lation platform 側面安裝平臺	Installation Deep (mm) 安裝深度	130mm Ø	118x65.5mm □	Eco
300	300	180	Yes	-	Yes	157	-	Yes	9090-0004
300	300	180	-	Yes	-	180	-	Yes	9090-0005
300	400	180	Yes	-	Yes	157	-	Yes	9090-0006
300	400	180	-	Yes	-	180	-	Yes	9090-0007
400	400	180	Yes	-	Yes	157	-	Yes	9090-0008
400	400	180	-	Yes	-	180	-	Yes	9090-0009
400	500	180	Yes	-	Yes	157	-	Yes	9090-0010
400	500	180	-	Yes	-	180	-	Yes	9090-0011
500	500	180	Yes	-	Yes	157	-	Yes	9090-0012
500	500	180	-	Yes	-	180	-	Yes	9090-0013
500	600	180	Yes	-	Yes	157	-	Yes	9090-0014
500	600	180	-	Yes	-	180	-	Yes	9090-0015
600	600	180	Yes	-	Yes	157	-	Yes	9090-0016
600	600	180	-	Yes	-	180	-	Yes	9090-0017

\*\* Please contact with us for non-standart panel sizes

ECO 9090.0200



Installation Area 安裝尺寸(範圍)			Back Area 背部安裝		Installation Depth 安裝深度		Support Arm No TK 連接管型號		Order No 訂貨號
Width (mm)	Height (mm)	Depth (mm)	Hinge 後開門型式	Screw 固定背板 型式	H profil profile instal- lation platform 側面安裝平臺	Installation Deep (mm) 安裝深度	130mm Ø	118x65.5mm □	Eco
300	300	180	Yes	-	Yes	157	-	Yes	9090-0204
300	300	180	-	Yes	-	180	-	Yes	9090-0205
300	400	180	Yes	-	Yes	157	-	Yes	9090-0206
300	400	180	-	Yes	-	180	-	Yes	9090-0207
400	400	180	Yes	-	Yes	157	-	Yes	9090-0208
400	400	180	-	Yes	-	180	-	Yes	9090-0209
400	500	180	Yes	-	Yes	157	-	Yes	9090-0210
400	500	180	-	Yes	-	180	-	Yes	9090-0211
500	500	180	Yes	-	Yes	157	-	Yes	9090-0212
500	500	180	-	Yes	-	180	-	Yes	9090-0213
500	600	180	Yes	-	Yes	157	-	Yes	9090-0214
500	600	180	-	Yes	-	180	-	Yes	9090-0215
600	600	180	Yes	-	Yes	157	-	Yes	9090-0216
600	600	180	-	Yes	-	180	-	Yes	9090-0217

\*\* Please contact with us for non-standart panel sizes

ECO 9090.0100



Installation Area 安裝尺寸(範圍)			Back Area 背部安裝		Installation Depth 安裝深度		Support Arm No TK 連接管型號		Order No 訂貨號
Width (mm)	Height (mm)	Depth (mm)	Hinge 後開門型式	Screw 固定背板 型式	H profil profile instal- lation platform 側面安裝平臺	Installation Deep (mm) 安裝深度	130mm Ø	118x65.5mm □	Eco
300	300	180	Yes	-	Yes	157	-	Yes	9090-0104
300	300	180	-	Yes	-	180	-	Yes	9090-0105
300	400	180	Yes	-	Yes	157	-	Yes	9090-0106
300	400	180	-	Yes	-	180	-	Yes	9090-0107
400	400	180	Yes	-	Yes	157	-	Yes	9090-0108
400	400	180	-	Yes	-	180	-	Yes	9090-0109
400	500	180	Yes	-	Yes	157	-	Yes	9090-0110
400	500	180	-	Yes	-	180	-	Yes	9090-0111
500	500	180	Yes	-	Yes	157	-	Yes	9090-0112
500	500	180	-	Yes	-	180	-	Yes	9090-0113
500	600	180	Yes	-	Yes	157	-	Yes	9090-0114
500	600	180	-	Yes	-	180	-	Yes	9090-0115
600	600	180	Yes	-	Yes	157	-	Yes	9090-0116
600	600	180	-	Yes	-	180	-	Yes	9090-0117

\*\* Please contact with us for non-standart panel sizes

ECO 9090.6000



Installation Area 安裝尺寸(範圍)			Back Area 背部安裝		Installation Depth 安裝深度		Support Arm No TK 連接管型號		Order No 訂貨號
Width (mm)	Height (mm)	Depth (mm)	Hinge 後開門型式	Screw 固定背板 型式	H profil profile instal- lation platform 側面安裝平臺	Installation Deep (mm) 安裝深度	130mm Ø	118x65.5mm □	Eco
300	300	180	Yes	-	Yes	157	-	Yes	9090-6004
300	300	180	-	Yes	-	180	-	Yes	9090-6005
300	400	180	Yes	-	Yes	157	-	Yes	9090-6006
300	400	180	-	Yes	-	180	-	Yes	9090-6007
400	400	180	Yes	-	Yes	157	-	Yes	9090-6008
400	400	180	-	Yes	-	180	-	Yes	9090-6009
400	500	180	Yes	-	Yes	157	-	Yes	9090-6010
400	500	180	-	Yes	-	180	-	Yes	9090-6011
500	500	180	Yes	-	Yes	157	-	Yes	9090-6012
500	500	180	-	Yes	-	180	-	Yes	9090-6013
500	600	180	Yes	-	Yes	157	-	Yes	9090-6014
500	600	180	-	Yes	-	180	-	Yes	9090-6015
600	600	180	Yes	-	Yes	157	-	Yes	9090-6016
600	600	180	-	Yes	-	180	-	Yes	9090-6017

\*Please contact with us for keyboard dimensions

ECO 90 SERIES PANEL

ECO 90 SERIES PANEL

ECO 9091.0000



Installation Area 安裝尺寸(範圍)			Back Area 背部安裝		Installation Depth 安裝深度		Support Arm No TK 連接管型號		Order No 訂貨號
Width (mm)	Height (mm)	Depth (mm)	Hinge 後開門型式	Screw 固定背板 型式	H profil profile instal- lation platform 側面安裝平臺	Installation Deep (mm) 安裝深度	130mm Ø	118x65.5mm □	Eco
300	300	180	Yes	-	Yes	157	-	Yes	9091-0004
300	300	180	-	Yes	-	180	-	Yes	9091-0005
300	400	180	Yes	-	Yes	157	-	Yes	9091-0006
300	400	180	-	Yes	-	180	-	Yes	9091-0007
400	400	180	Yes	-	Yes	157	-	Yes	9091-0008
400	400	180	-	Yes	-	180	-	Yes	9091-0009
400	500	180	Yes	-	Yes	157	-	Yes	9091-0010
400	500	180	-	Yes	-	180	-	Yes	9091-0011
500	500	180	Yes	-	Yes	157	-	Yes	9091-0012
500	500	180	-	Yes	-	180	-	Yes	9091-0013
500	600	180	Yes	-	Yes	157	-	Yes	9091-0014
500	600	180	-	Yes	-	180	-	Yes	9091-0015
600	600	180	Yes	-	Yes	157	-	Yes	9091-0016
600	600	180	-	Yes	-	180	-	Yes	9091-0017

\*\* Please contact with us for non-standart panel sizes

ECO 9091.0200



Installation Area 安裝尺寸(範圍)			Back Area 背部安裝		Installation Depth 安裝深度		Support Arm No TK 連接管型號		Order No 訂貨號
Width (mm)	Height (mm)	Depth (mm)	Hinge 後開門型式	Screw 固定背板 型式	H profil profile instal- lation platform 側面安裝平臺	Installation Deep (mm) 安裝深度	130mm Ø	118x65.5mm □	Eco
300	300	180	Yes	-	Yes	157	-	Yes	9091-0204
300	300	180	-	Yes	-	180	-	Yes	9091-0205
300	400	180	Yes	-	Yes	157	-	Yes	9091-0206
300	400	180	-	Yes	-	180	-	Yes	9091-0207
400	400	180	Yes	-	Yes	157	-	Yes	9091-0208
400	400	180	-	Yes	-	180	-	Yes	9091-0209
400	500	180	Yes	-	Yes	157	-	Yes	9091-0210
400	500	180	-	Yes	-	180	-	Yes	9091-0211
500	500	180	Yes	-	Yes	157	-	Yes	9091-0212
500	500	180	-	Yes	-	180	-	Yes	9091-0213
500	600	180	Yes	-	Yes	157	-	Yes	9091-0214
500	600	180	-	Yes	-	180	-	Yes	9091-0215
600	600	180	Yes	-	Yes	157	-	Yes	9091-0216
600	600	180	-	Yes	-	180	-	Yes	9091-0217

\*\* Please contact with us for non-standart panel sizes

ECO 9091.0100



Installation Area 安裝尺寸(範圍)			Back Area 背部安裝		Installation Depth 安裝深度		Support Arm No TK 連接管型號		Order No 訂貨號
Width (mm)	Height (mm)	Depth (mm)	Hinge 後開門型式	Screw 固定背板 型式	H profil profile instal- lation platform 側面安裝平臺	Installation Deep (mm) 安裝深度	130mm Ø	118x65.5mm □	Eco
300	300	180	Yes	-	Yes	157	-	Yes	9091-0104
300	300	180	-	Yes	-	180	-	Yes	9091-0105
300	400	180	Yes	-	Yes	157	-	Yes	9091-0106
300	400	180	-	Yes	-	180	-	Yes	9091-0107
400	400	180	Yes	-	Yes	157	-	Yes	9091-0108
400	400	180	-	Yes	-	180	-	Yes	9091-0109
400	500	180	Yes	-	Yes	157	-	Yes	9091-0110
400	500	180	-	Yes	-	180	-	Yes	9091-0111
500	500	180	Yes	-	Yes	157	-	Yes	9091-0112
500	500	180	-	Yes	-	180	-	Yes	6091-0113
500	600	180	Yes	-	Yes	157	-	Yes	9091-0114
500	600	180	-	Yes	-	180	-	Yes	9091-0115
600	600	180	Yes	-	Yes	157	-	Yes	9091-0116
600	600	180	-	Yes	-	180	-	Yes	9091-0117

\*\* Please contact with us for non-standart panel sizes

ECO 9091.6000



Installation Area 安裝尺寸(範圍)			Back Area 背部安裝		Installation Depth 安裝深度		Support Arm No TK 連接管型號		Order No 訂貨號
Width (mm)	Height (mm)	Depth (mm)	Hinge 後開門型式	Screw 固定背板 型式	H profil profile instal- lation platform 側面安裝平臺	Installation Deep (mm) 安裝深度	130mm Ø	118x65.5mm □	Eco
300	300	180	Yes	-	Yes	157	-	Yes	9091-6004
300	300	180	-	Yes	-	180	-	Yes	9091-6005
300	400	180	Yes	-	Yes	157	-	Yes	9091-6006
300	400	180	-	Yes	-	180	-	Yes	9091-6007
400	400	180	Yes	-	Yes	157	-	Yes	9091-6008
400	400	180	-	Yes	-	180	-	Yes	9091-6009
400	500	180	Yes	-	Yes	157	-	Yes	9091-6010
400	500	180	-	Yes	-	180	-	Yes	9091-6011
500	500	180	Yes	-	Yes	157	-	Yes	9091-6012
500	500	180	-	Yes	-	180	-	Yes	9091-6013
500	600	180	Yes	-	Yes	157	-	Yes	9091-6014
500	600	180	-	Yes	-	180	-	Yes	9091-6015
600	600	180	Yes	-	Yes	157	-	Yes	9091-6016
600	600	180	-	Yes	-	180	-	Yes	9091-6017

\*Please contact with us for keyboard dimensions

ECO 120 SERIES PANEL

ECO 120 SERIES PANEL

**ECO** 1200.0000



Installation Area 安裝尺寸(範圍)			Back Area 背部安裝		Installation Depth 安裝深度		Support Arm No TK 連接管型號		Order No 訂貨號
Width (mm)	Height (mm)	Depth (mm)	Hinge 後開門型式	Screw 固定背板 型式	H profil profile instal- lation platform 側面安裝平臺	Installation Deep (mm) 安裝深度	130mm Ø	118x65.5mm □	Eco
300	300	120	Yes	-	Yes	97	-	Yes	1200-0004
300	300	120	-	Yes	-	120	-	Yes	1200-0005
300	400	120	Yes	-	Yes	97	-	Yes	1200-0006
300	400	120	-	Yes	-	120	-	Yes	1200-0007
400	400	120	Yes	-	Yes	97	-	Yes	1200-0008
400	400	120	-	Yes	-	120	-	Yes	1200-0009
400	500	120	Yes	-	Yes	97	-	Yes	1200-0010
400	500	120	-	Yes	-	120	-	Yes	1200-0011
500	500	120	Yes	-	Yes	97	-	Yes	1200-0012
500	500	120	-	Yes	-	120	-	Yes	1200-0013
500	600	120	Yes	-	Yes	97	-	Yes	1200-0014
500	600	120	-	Yes	-	120	-	Yes	1200-0015
600	600	120	Yes	-	Yes	97	-	Yes	1200-0016
600	600	120	-	Yes	-	120	-	Yes	1200-0017

\*\* Please contact with us for non-standart panel sizes

**ECO** 1200.0200



Installation Area 安裝尺寸(範圍)			Back Area 背部安裝		Installation Depth 安裝深度		Support Arm No TK 連接管型號		Order No 訂貨號
Width (mm)	Height (mm)	Depth (mm)	Hinge 後開門型式	Screw 固定背板 型式	H profil profile instal- lation platform 側面安裝平臺	Installation Deep (mm) 安裝深度	130mm Ø	118x65.5mm □	Eco
300	300	120	Yes	-	Yes	97	-	Yes	1200-0204
300	300	120	-	Yes	-	120	-	Yes	1200-0205
300	400	120	Yes	-	Yes	97	-	Yes	1200-0206
300	400	120	-	Yes	-	120	-	Yes	1200-0207
400	400	120	Yes	-	Yes	97	-	Yes	1200-0208
400	400	120	-	Yes	-	120	-	Yes	1200-0209
400	500	120	Yes	-	Yes	97	-	Yes	1200-0210
400	500	120	-	Yes	-	120	-	Yes	1200-0211
500	500	120	Yes	-	Yes	97	-	Yes	1200-0212
500	500	120	-	Yes	-	120	-	Yes	1200-0213
500	600	120	Yes	-	Yes	97	-	Yes	1200-0214
500	600	120	-	Yes	-	120	-	Yes	1200-0215
600	600	120	Yes	-	Yes	97	-	Yes	1200-0216
600	600	120	-	Yes	-	120	-	Yes	1200-0217

\*\* Please contact with us for non-standart panel sizes

**ECO** 1200.0100



Installation Area 安裝尺寸(範圍)			Back Area 背部安裝		Installation Depth 安裝深度		Support Arm No TK 連接管型號		Order No 訂貨號
Width (mm)	Height (mm)	Depth (mm)	Hinge 後開門型式	Screw 固定背板 型式	H profil profile instal- lation platform 側面安裝平臺	Installation Deep (mm) 安裝深度	130mm Ø	118x65.5mm □	Eco
300	300	120	Yes	-	Yes	97	-	Yes	1200-0104
300	300	120	-	Yes	-	120	-	Yes	1200-0105
300	400	120	Yes	-	Yes	97	-	Yes	1200-0106
300	400	120	-	Yes	-	120	-	Yes	1200-0107
400	400	120	Yes	-	Yes	97	-	Yes	1200-0108
400	400	120	-	Yes	-	120	-	Yes	1200-0109
400	500	120	Yes	-	Yes	97	-	Yes	1200-0110
400	500	120	-	Yes	-	120	-	Yes	1200-0111
500	500	120	Yes	-	Yes	97	-	Yes	1200-0112
500	500	120	-	Yes	-	120	-	Yes	1200-0113
500	600	120	Yes	-	Yes	97	-	Yes	1200-0114
500	600	120	-	Yes	-	120	-	Yes	1200-0115
600	600	120	Yes	-	Yes	97	-	Yes	1200-0116
600	600	120	-	Yes	-	120	-	Yes	1200-0117

\*\* Please contact with us for non-standart panel sizes

**ECO** 1200.9000



Installation Area 安裝尺寸(範圍)			Back Area 背部安裝		Installation Depth 安裝深度		Support Arm No TK 連接管型號		Order No 訂貨號
Width (mm)	Height (mm)	Depth (mm)	Hinge 後開門型式	Screw 固定背板 型式	H profil profile instal- lation platform 側面安裝平臺	Installation Deep (mm) 安裝深度	130mm Ø	118x65.5mm □	Eco
300	300	120	Yes	-	Yes	97	-	Yes	1200-9004
300	300	120	-	Yes	-	120	-	Yes	1200-9005
300	400	120	Yes	-	Yes	97	-	Yes	1200-9006
300	400	120	-	Yes	-	120	-	Yes	1200-9007
400	400	120	Yes	-	Yes	97	-	Yes	1200-9008
400	400	120	-	Yes	-	120	-	Yes	1200-9009
400	500	120	Yes	-	Yes	97	-	Yes	1200-9010
400	500	120	-	Yes	-	120	-	Yes	1200-9011
500	500	120	Yes	-	Yes	97	-	Yes	1200-9012
500	500	120	-	Yes	-	120	-	Yes	1200-9013
500	600	120	Yes	-	Yes	97	-	Yes	1200-9014
500	600	120	-	Yes	-	120	-	Yes	1200-9015
600	600	120	Yes	-	Yes	97	-	Yes	1200-9016
600	600	120	-	Yes	-	120	-	Yes	1200-9017

\*Please contact with us for keyboard dimensions



ECO 120 SERIES PANEL

ECO 120 SERIES PANEL

**ECO** 1290.0000



Installation Area 安裝尺寸(範圍)			Back Area 背部安裝		Installation Depth 安裝深度		Support Arm No TK 連接管型號		Order No 訂貨號
Width (mm)	Height (mm)	Depth (mm)	Hinge 後開門型式	Screw 固定背板 型式	H profil profile instal- lation platform 側面安裝平臺	Installation Deep (mm) 安裝深度	130mm Ø	118x65.5mm □	Eco
300	300	210	Yes	-	Yes	187	-	Yes	1290-0004
300	300	210	-	Yes	-	210	-	Yes	1290-0005
300	400	210	Yes	-	Yes	187	-	Yes	1290-0006
300	400	210	-	Yes	-	210	-	Yes	1290-0007
400	400	210	Yes	-	Yes	187	-	Yes	1290-0008
400	400	210	-	Yes	-	210	-	Yes	1290-0009
400	500	210	Yes	-	Yes	187	-	Yes	1290-0010
400	500	210	-	Yes	-	210	-	Yes	1290-0011
500	500	210	Yes	-	Yes	187	-	Yes	1290-0012
500	500	210	-	Yes	-	210	-	Yes	1290-0013
500	600	210	Yes	-	Yes	187	-	Yes	1290-0014
500	600	210	-	Yes	-	210	-	Yes	1290-0015
600	600	210	Yes	-	Yes	187	-	Yes	1290-0016
600	600	210	-	Yes	-	210	-	Yes	1290-0017

\*\* Please contact with us for non-standart panel sizes

**ECO** 1290.0200



Installation Area 安裝尺寸(範圍)			Back Area 背部安裝		Installation Depth 安裝深度		Support Arm No TK 連接管型號		Order No 訂貨號
Width (mm)	Height (mm)	Depth (mm)	Hinge 後開門型式	Screw 固定背板 型式	H profil profile instal- lation platform 側面安裝平臺	Installation Deep (mm) 安裝深度	130mm Ø	118x65.5mm □	Eco
300	300	210	Yes	-	Yes	187	-	Yes	1290-0204
300	300	210	-	Yes	-	210	-	Yes	1290-0205
300	400	210	Yes	-	Yes	187	-	Yes	1290-0206
300	400	210	-	Yes	-	210	-	Yes	1290-0207
400	400	210	Yes	-	Yes	187	-	Yes	1290-0208
400	400	210	-	Yes	-	210	-	Yes	1290-0209
400	500	210	Yes	-	Yes	187	-	Yes	1290-0210
400	500	210	-	Yes	-	210	-	Yes	1290-0211
500	500	210	Yes	-	Yes	187	-	Yes	1290-0212
500	500	210	-	Yes	-	210	-	Yes	1290-0213
500	600	210	Yes	-	Yes	187	-	Yes	1290-0214
500	600	210	-	Yes	-	210	-	Yes	1290-0215
600	600	210	Yes	-	Yes	187	-	Yes	1290-0216
600	600	210	-	Yes	-	210	-	Yes	1290-0217

\*\* Please contact with us for non-standart panel sizes

**ECO** 1290.0100



Installation Area 安裝尺寸(範圍)			Back Area 背部安裝		Installation Depth 安裝深度		Support Arm No TK 連接管型號		Order No 訂貨號
Width (mm)	Height (mm)	Depth (mm)	Hinge 後開門型式	Screw 固定背板 型式	H profil profile instal- lation platform 側面安裝平臺	Installation Deep (mm) 安裝深度	130mm Ø	118x65.5mm □	Eco
300	300	210	Yes	-	Yes	187	-	Yes	1290-0104
300	300	210	-	Yes	-	210	-	Yes	1290-0105
300	400	210	Yes	-	Yes	187	-	Yes	1290-0106
300	400	210	-	Yes	-	210	-	Yes	1290-0107
400	400	210	Yes	-	Yes	187	-	Yes	1290-0108
400	400	210	-	Yes	-	210	-	Yes	1290-0109
400	500	210	Yes	-	Yes	187	-	Yes	1290-0110
400	500	210	-	Yes	-	210	-	Yes	1290-0111
500	500	210	Yes	-	Yes	187	-	Yes	1290-0112
500	500	210	-	Yes	-	210	-	Yes	1290-0113
500	600	210	Yes	-	Yes	187	-	Yes	1290-0114
500	600	210	-	Yes	-	210	-	Yes	1290-0115
600	600	210	Yes	-	Yes	187	-	Yes	1290-0116
600	600	210	-	Yes	-	210	-	Yes	1290-0117

\*\* Please contact with us for non-standart panel sizes

**ECO** 1290.9000



Installation Area 安裝尺寸(範圍)			Back Area 背部安裝		Installation Depth 安裝深度		Support Arm No TK 連接管型號		Order No 訂貨號
Width (mm)	Height (mm)	Depth (mm)	Hinge 後開門型式	Screw 固定背板 型式	H profil profile instal- lation platform 側面安裝平臺	Installation Deep (mm) 安裝深度	130mm Ø	118x65.5mm □	Eco
300	300	210	Yes	-	Yes	187	-	Yes	1290-9004
300	300	210	-	Yes	-	210	-	Yes	1290-9005
300	400	210	Yes	-	Yes	187	-	Yes	1290-9006
300	400	210	-	Yes	-	210	-	Yes	1290-9007
400	400	210	Yes	-	Yes	187	-	Yes	1290-9008
400	400	210	-	Yes	-	210	-	Yes	1290-9009
400	500	210	Yes	-	Yes	187	-	Yes	1290-9010
400	500	210	-	Yes	-	210	-	Yes	1290-9011
500	500	210	Yes	-	Yes	187	-	Yes	1290-9012
500	500	210	-	Yes	-	210	-	Yes	1290-9013
500	600	210	Yes	-	Yes	187	-	Yes	1290-9014
500	600	210	-	Yes	-	210	-	Yes	1290-9015
600	600	210	Yes	-	Yes	187	-	Yes	1290-9016
600	600	210	-	Yes	-	210	-	Yes	1290-9017

\*Please contact with us for keyboard dimensions

ECO 120 SERIES PANEL

ECO 120 SERIES PANEL

**ECO** 1291.0000



Installation Area 安裝尺寸(範圍)			Back Area 背部安裝		Installation Depth 安裝深度		Support Arm No TK 連接管型號		Order No 訂貨號
Width (mm)	Height (mm)	Depth (mm)	Hinge 後開門型式	Screw 固定背板 型式	H profil profile instal- lation platform 側面安裝平臺	Installation Deep (mm) 安裝深度	130mm Ø	118x65.5mm □	Eco
300	300	210	Yes	-	Yes	187	-	Yes	1291-0004
300	300	210	-	Yes	-	210	-	Yes	1291-0005
300	400	210	Yes	-	Yes	187	-	Yes	1291-0006
300	400	210	-	Yes	-	210	-	Yes	1291-0007
400	400	210	Yes	-	Yes	187	-	Yes	1291-0008
400	400	210	-	Yes	-	210	-	Yes	1291-0009
400	500	210	Yes	-	Yes	187	-	Yes	1291-0010
400	500	210	-	Yes	-	210	-	Yes	1291-0011
500	500	210	Yes	-	Yes	187	-	Yes	1291-0012
500	500	210	-	Yes	-	210	-	Yes	1291-0013
500	600	210	Yes	-	Yes	187	-	Yes	1291-0014
500	600	210	-	Yes	-	210	-	Yes	1291-0015
600	600	210	Yes	-	Yes	187	-	Yes	1291-0016
600	600	210	-	Yes	-	210	-	Yes	1291-0017

\*\* Please contact with us for non-standart panel sizes

**ECO** 1291.0200



Installation Area 安裝尺寸(範圍)			Back Area 背部安裝		Installation Depth 安裝深度		Support Arm No TK 連接管型號		Order No 訂貨號
Width (mm)	Height (mm)	Depth (mm)	Hinge 後開門型式	Screw 固定背板 型式	H profil profile instal- lation platform 側面安裝平臺	Installation Deep (mm) 安裝深度	130mm Ø	118x65.5mm □	Eco
300	300	210	Yes	-	Yes	187	-	Yes	1291-0204
300	300	210	-	Yes	-	210	-	Yes	1291-0205
300	400	210	Yes	-	Yes	187	-	Yes	1291-0206
300	400	210	-	Yes	-	210	-	Yes	1291-0207
400	400	210	Yes	-	Yes	187	-	Yes	1291-0208
400	400	210	-	Yes	-	210	-	Yes	1291-0209
400	500	210	Yes	-	Yes	187	-	Yes	1291-0210
400	500	210	-	Yes	-	210	-	Yes	1291-0211
500	500	210	Yes	-	Yes	187	-	Yes	1291-0212
500	500	210	-	Yes	-	210	-	Yes	1291-0213
500	600	210	Yes	-	Yes	187	-	Yes	1291-0214
500	600	210	-	Yes	-	210	-	Yes	1291-0215
600	600	210	Yes	-	Yes	187	-	Yes	1291-0216
600	600	210	-	Yes	-	210	-	Yes	1291-0217

\*\* Please contact with us for non-standart panel sizes

**ECO** 1291.0100



Installation Area 安裝尺寸(範圍)			Back Area 背部安裝		Installation Depth 安裝深度		Support Arm No TK 連接管型號		Order No 訂貨號
Width (mm)	Height (mm)	Depth (mm)	Hinge 後開門型式	Screw 固定背板 型式	H profil profile instal- lation platform 側面安裝平臺	Installation Deep (mm) 安裝深度	130mm Ø	118x65.5mm □	Eco
300	300	210	Yes	-	Yes	187	-	Yes	1291-0104
300	300	210	-	Yes	-	210	-	Yes	1291-0105
300	400	210	Yes	-	Yes	187	-	Yes	1291-0106
300	400	210	-	Yes	-	210	-	Yes	1291-0107
400	400	210	Yes	-	Yes	187	-	Yes	1291-0108
400	400	210	-	Yes	-	210	-	Yes	1291-0109
400	500	210	Yes	-	Yes	187	-	Yes	1291-0110
400	500	210	-	Yes	-	210	-	Yes	1291-0111
500	500	210	Yes	-	Yes	187	-	Yes	1291-0112
500	500	210	-	Yes	-	210	-	Yes	1291-0113
500	600	210	Yes	-	Yes	187	-	Yes	1291-0114
500	600	210	-	Yes	-	210	-	Yes	1291-0115
600	600	210	Yes	-	Yes	187	-	Yes	1291-0116
600	600	210	-	Yes	-	210	-	Yes	1291-0117

\*\* Please contact with us for non-standart panel sizes

**ECO** 1291.9000



Installation Area 安裝尺寸(範圍)			Back Area 背部安裝		Installation Depth 安裝深度		Support Arm No TK 連接管型號		Order No 訂貨號
Width (mm)	Height (mm)	Depth (mm)	Hinge 後開門型式	Screw 固定背板 型式	H profil profile instal- lation platform 側面安裝平臺	Installation Deep (mm) 安裝深度	130mm Ø	118x65.5mm □	Eco
300	300	210	Yes	-	Yes	187	-	Yes	1291-9004
300	300	210	-	Yes	-	210	-	Yes	1291-9005
300	400	210	Yes	-	Yes	187	-	Yes	1291-9006
300	400	210	-	Yes	-	210	-	Yes	1291-9007
400	400	210	Yes	-	Yes	187	-	Yes	1291-9008
400	400	210	-	Yes	-	210	-	Yes	1291-9009
400	500	210	Yes	-	Yes	187	-	Yes	1291-9010
400	500	210	-	Yes	-	210	-	Yes	1291-9011
500	500	210	Yes	-	Yes	187	-	Yes	1291-9012
500	500	210	-	Yes	-	210	-	Yes	1291-9013
500	600	210	Yes	-	Yes	187	-	Yes	1291-9014
500	600	210	-	Yes	-	210	-	Yes	1291-9015
600	600	210	Yes	-	Yes	187	-	Yes	1291-9016
600	600	210	-	Yes	-	210	-	Yes	1291-9017

\*Please contact with us for keyboard dimensions

ECO 150 SERIES PANEL

ECO 150 SERIES PANEL

**ECO** 1500.0000



Installation Area 安裝尺寸(範圍)			Back Area 背部安裝		Installation Depth 安裝深度		Support Arm No TK 連接管型號		Order No 訂貨號
Width (mm)	Height (mm)	Depth (mm)	Hinge 後開門型式	Screw 固定背板 型式	H profil profile instal- lation platform 側面安裝平臺	Installation Deep (mm) 安裝深度	130mm Ø	118x65.5mm □	Eco
300	300	150	Yes	-	Yes	127	Yes	-	1500-0004
300	300	150	-	Yes	-	150	Yes	-	1500-0005
300	400	150	Yes	-	Yes	127	Yes	-	1500-0006
300	400	150	-	Yes	-	150	Yes	-	1500-0007
400	400	150	Yes	-	Yes	127	Yes	-	1500-0008
400	400	150	-	Yes	-	150	Yes	-	1500-0009
400	500	150	Yes	-	Yes	127	Yes	-	1500-0010
400	500	150	-	Yes	-	150	Yes	-	1500-0011
500	500	150	Yes	-	Yes	127	Yes	-	1500-0012
500	500	150	-	Yes	-	150	Yes	-	1500-0013
500	600	150	Yes	-	Yes	127	Yes	-	1500-0014
500	600	150	-	Yes	-	150	Yes	-	1500-0015
600	600	150	Yes	-	Yes	127	Yes	-	1500-0016
600	600	150	-	Yes	-	150	Yes	-	1500-0017

\*\* Please contact with us for non-standart panel sizes

**ECO** 1500.0200



Installation Area 安裝尺寸(範圍)			Back Area 背部安裝		Installation Depth 安裝深度		Support Arm No TK 連接管型號		Order No 訂貨號
Width (mm)	Height (mm)	Depth (mm)	Hinge 後開門型式	Screw 固定背板 型式	H profil profile instal- lation platform 側面安裝平臺	Installation Deep (mm) 安裝深度	130mm Ø	118x65.5mm □	Eco
300	300	150	Yes	-	Yes	127	Yes	-	1500-0204
300	300	150	-	Yes	-	150	Yes	-	1500-0205
300	400	150	Yes	-	Yes	127	Yes	-	1500-0206
300	400	150	-	Yes	-	150	Yes	-	1500-0207
400	400	150	Yes	-	Yes	127	Yes	-	1500-0208
400	400	150	-	Yes	-	150	Yes	-	1500-0209
400	500	150	Yes	-	Yes	127	Yes	-	1500-0210
400	500	150	-	Yes	-	150	Yes	-	1500-0211
500	500	150	Yes	-	Yes	127	Yes	-	1500-0212
500	500	150	-	Yes	-	150	Yes	-	1500-0213
500	600	150	Yes	-	Yes	127	Yes	-	1500-0214
500	600	150	-	Yes	-	150	Yes	-	1500-0215
600	600	150	Yes	-	Yes	127	Yes	-	1500-0216
600	600	150	-	Yes	-	150	Yes	-	1500-0217

\*\* Please contact with us for non-standart panel sizes

**ECO** 1500.0100



Installation Area 安裝尺寸(範圍)			Back Area 背部安裝		Installation Depth 安裝深度		Support Arm No TK 連接管型號		Order No 訂貨號
Width (mm)	Height (mm)	Depth (mm)	Hinge 後開門型式	Screw 固定背板 型式	H profil profile instal- lation platform 側面安裝平臺	Installation Deep (mm) 安裝深度	130mm Ø	118x65.5mm □	Eco
300	300	150	Yes	-	Yes	127	Yes	-	1500-0104
300	300	150	-	Yes	-	150	Yes	-	1500-0105
300	400	150	Yes	-	Yes	127	Yes	-	1500-0106
300	400	150	-	Yes	-	150	Yes	-	1500-0107
400	400	150	Yes	-	Yes	127	Yes	-	1500-0108
400	400	150	-	Yes	-	150	Yes	-	1500-0109
400	500	150	Yes	-	Yes	127	Yes	-	1500-0110
400	500	150	-	Yes	-	150	Yes	-	1500-0111
500	500	150	Yes	-	Yes	127	Yes	-	1500-0112
500	500	150	-	Yes	-	150	Yes	-	1500-0113
500	600	150	Yes	-	Yes	127	Yes	-	1500-0114
500	600	150	-	Yes	-	150	Yes	-	1500-0115
600	600	150	Yes	-	Yes	127	Yes	-	1500-0116
600	600	150	-	Yes	-	150	Yes	-	1500-0117

\*\* Please contact with us for non-standart panel sizes

**ECO** 1500.1200



Installation Area 安裝尺寸(範圍)			Back Area 背部安裝		Installation Depth 安裝深度		Support Arm No TK 連接管型號		Order No 訂貨號
Width (mm)	Height (mm)	Depth (mm)	Hinge 後開門型式	Screw 固定背板 型式	H profil profile instal- lation platform 側面安裝平臺	Installation Deep (mm) 安裝深度	130mm Ø	118x65.5mm □	Eco
300	300	150	Yes	-	Yes	127	Yes	-	1500-1204
300	300	150	-	Yes	-	150	Yes	-	1500-1205
300	400	150	Yes	-	Yes	127	Yes	-	1500-1206
300	400	150	-	Yes	-	150	Yes	-	1500-1207
400	400	150	Yes	-	Yes	127	Yes	-	1500-1208
400	400	150	-	Yes	-	150	Yes	-	1500-1209
400	500	150	Yes	-	Yes	127	Yes	-	1500-1210
400	500	150	-	Yes	-	150	Yes	-	1500-1211
500	500	150	Yes	-	Yes	127	Yes	-	1500-1212
500	500	150	-	Yes	-	150	Yes	-	1500-1213
500	600	150	Yes	-	Yes	127	Yes	-	1500-1214
500	600	150	-	Yes	-	150	Yes	-	1500-1215
600	600	150	Yes	-	Yes	127	Yes	-	1500-1216
600	600	150	-	Yes	-	150	Yes	-	1500-1217

\*Please contact with us for keyboard dimensions



ECO 150 SERIES PANEL

ECO 150 SERIES PANEL

**ECO** 1590.0000



Installation Area 安裝尺寸(範圍)			Back Area 背部安裝		Installation Depth 安裝深度		Support Arm No TK 連接管型號		Order No 訂貨號
Width (mm)	Height (mm)	Depth (mm)	Hinge 後開門型式	Screw 固定背板 型式	H profil profile instal- lation platform 側面安裝平臺	Installation Deep (mm) 安裝深度	130mm Ø	118x65.5mm □	Eco
300	300	240	Yes	-	Yes	217	Yes	-	1590-0004
300	300	240	-	Yes	-	240	Yes	-	1590-0005
300	400	240	Yes	-	Yes	217	Yes	-	1590-0006
300	400	240	-	Yes	-	240	Yes	-	1590-0007
400	400	240	Yes	-	Yes	217	Yes	-	1590-0008
400	400	240	-	Yes	-	240	Yes	-	1590-0009
400	500	240	Yes	-	Yes	217	Yes	-	1590-0010
400	500	240	-	Yes	-	240	Yes	-	1590-0011
500	500	240	Yes	-	Yes	217	Yes	-	1590-0012
500	500	240	-	Yes	-	240	Yes	-	1590-0013
500	600	240	Yes	-	Yes	217	Yes	-	1590-0014
500	600	240	-	Yes	-	240	Yes	-	1590-0015
600	600	240	Yes	-	Yes	217	Yes	-	1590-0016
600	600	240	-	Yes	-	240	Yes	-	1590-0017

\*\* Please contact with us for non-standart panel sizes

**ECO** 1590.0200



Installation Area 安裝尺寸(範圍)			Back Area 背部安裝		Installation Depth 安裝深度		Support Arm No TK 連接管型號		Order No 訂貨號
Width (mm)	Height (mm)	Depth (mm)	Hinge 後開門型式	Screw 固定背板 型式	H profil profile instal- lation platform 側面安裝平臺	Installation Deep (mm) 安裝深度	130mm Ø	118x65.5mm □	Eco
300	300	240	Yes	-	Yes	217	Yes	-	1590-0204
300	300	240	-	Yes	-	240	Yes	-	1590-0205
300	400	240	Yes	-	Yes	217	Yes	-	1590-0206
300	400	240	-	Yes	-	240	Yes	-	1590-0207
400	400	240	Yes	-	Yes	217	Yes	-	1590-0208
400	400	240	-	Yes	-	240	Yes	-	1590-0209
400	500	240	Yes	-	Yes	217	Yes	-	1590-0210
400	500	240	-	Yes	-	240	Yes	-	1590-0211
500	500	240	Yes	-	Yes	217	Yes	-	1590-0212
500	500	240	-	Yes	-	240	Yes	-	1590-0213
500	600	240	Yes	-	Yes	217	Yes	-	1590-0214
500	600	240	-	Yes	-	240	Yes	-	1590-0215
600	600	240	Yes	-	Yes	217	Yes	-	1590-0216
600	600	240	-	Yes	-	240	Yes	-	1590-0217

\*\* Please contact with us for non-standart panel sizes

**ECO** 1590.0100



Installation Area 安裝尺寸(範圍)			Back Area 背部安裝		Installation Depth 安裝深度		Support Arm No TK 連接管型號		Order No 訂貨號
Width (mm)	Height (mm)	Depth (mm)	Hinge 後開門型式	Screw 固定背板 型式	H profil profile instal- lation platform 側面安裝平臺	Installation Deep (mm) 安裝深度	130mm Ø	118x65.5mm □	Eco
300	300	240	Yes	-	Yes	217	Yes	-	1590-0104
300	300	240	-	Yes	-	240	Yes	-	1590-0105
300	400	240	Yes	-	Yes	217	Yes	-	1590-0106
300	400	240	-	Yes	-	240	Yes	-	1590-0107
400	400	240	Yes	-	Yes	217	Yes	-	1590-0108
400	400	240	-	Yes	-	240	Yes	-	1590-0109
400	500	240	Yes	-	Yes	217	Yes	-	1590-0110
400	500	240	-	Yes	-	240	Yes	-	1590-0111
500	500	240	Yes	-	Yes	217	Yes	-	1590-0112
500	500	240	-	Yes	-	240	Yes	-	1590-0113
500	600	240	Yes	-	Yes	217	Yes	-	1590-0114
500	600	240	-	Yes	-	240	Yes	-	1590-0115
600	600	240	Yes	-	Yes	217	Yes	-	1590-0116
600	600	240	-	Yes	-	240	Yes	-	1590-0117

\*\* Please contact with us for non-standart panel sizes

**ECO** 1590.1200



Installation Area 安裝尺寸(範圍)			Back Area 背部安裝		Installation Depth 安裝深度		Support Arm No TK 連接管型號		Order No 訂貨號
Width (mm)	Height (mm)	Depth (mm)	Hinge 後開門型式	Screw 固定背板 型式	H profil profile instal- lation platform 側面安裝平臺	Installation Deep (mm) 安裝深度	130mm Ø	118x65.5mm □	Eco
300	300	240	Yes	-	Yes	217	Yes	-	1590-6004
300	300	240	-	Yes	-	240	Yes	-	1590-6005
300	400	240	Yes	-	Yes	217	Yes	-	1590-6006
300	400	240	-	Yes	-	240	Yes	-	1590-6007
400	400	240	Yes	-	Yes	217	Yes	-	1590-6008
400	400	240	-	Yes	-	240	Yes	-	1590-6009
400	500	240	Yes	-	Yes	217	Yes	-	1590-6010
400	500	240	-	Yes	-	240	Yes	-	1590-6011
500	500	240	Yes	-	Yes	217	Yes	-	1590-6012
500	500	240	-	Yes	-	240	Yes	-	1590-6013
500	600	240	Yes	-	Yes	217	Yes	-	1590-6014
500	600	240	-	Yes	-	240	Yes	-	1590-6015
600	600	240	Yes	-	Yes	217	Yes	-	1590-6016
600	600	240	-	Yes	-	240	Yes	-	1590-6017

\*Please contact with us for keyboard dimensions

ECO 120 SERIES PANEL

ECO 120 SERIES PANEL

**ECO** 1591.0000



Installation Area 安裝尺寸(範圍)			Back Area 背部安裝		Installation Depth 安裝深度		Support Arm No TK 連接管型號		Order No 訂貨號
Width (mm)	Height (mm)	Depth (mm)	Hinge 後開門型式	Screw 固定背板 型式	H profil profile instal- lation platform 側面安裝平臺	Installation Deep (mm) 安裝深度	130mm Ø	118x65.5mm □	Eco
300	300	240	Yes	-	Yes	217	Yes	-	1591-0004
300	300	240	-	Yes	-	240	Yes	-	1591-0005
300	400	240	Yes	-	Yes	217	Yes	-	1591-0006
300	400	240	-	Yes	-	240	Yes	-	1591-0007
400	400	240	Yes	-	Yes	217	Yes	-	1591-0008
400	400	240	-	Yes	-	240	Yes	-	1591-0009
400	500	240	Yes	-	Yes	217	Yes	-	1591-0010
400	500	240	-	Yes	-	240	Yes	-	1591-0011
500	500	240	Yes	-	Yes	217	Yes	-	1591-0012
500	500	240	-	Yes	-	240	Yes	-	1591-0013
500	600	240	Yes	-	Yes	217	Yes	-	1591-0014
500	600	240	-	Yes	-	240	Yes	-	1591-0015
600	600	240	Yes	-	Yes	217	Yes	-	1591-0016
600	600	240	-	Yes	-	240	Yes	-	1591-0017

\*\* Please contact with us for non-standart panel sizes

**ECO** 1591.0200



Installation Area 安裝尺寸(範圍)			Back Area 背部安裝		Installation Depth 安裝深度		Support Arm No TK 連接管型號		Order No 訂貨號
Width (mm)	Height (mm)	Depth (mm)	Hinge 後開門型式	Screw 固定背板 型式	H profil profile instal- lation platform 側面安裝平臺	Installation Deep (mm) 安裝深度	130mm Ø	118x65.5mm □	Eco
300	300	240	Yes	-	Yes	217	Yes	-	1591-0204
300	300	240	-	Yes	-	240	Yes	-	1591-0205
300	400	240	Yes	-	Yes	217	Yes	-	1591-0206
300	400	240	-	Yes	-	240	Yes	-	1591-0207
400	400	240	Yes	-	Yes	217	Yes	-	1591-0208
400	400	240	-	Yes	-	240	Yes	-	1591-0209
400	500	240	Yes	-	Yes	217	Yes	-	1591-0210
400	500	240	-	Yes	-	240	Yes	-	1591-0211
500	500	240	Yes	-	Yes	217	Yes	-	1591-0212
500	500	240	-	Yes	-	240	Yes	-	1591-0213
500	600	240	Yes	-	Yes	217	Yes	-	1591-0214
500	600	240	-	Yes	-	240	Yes	-	1591-0215
600	600	240	Yes	-	Yes	217	Yes	-	1591-0216
600	600	240	-	Yes	-	240	Yes	-	1591-0217

\*\* Please contact with us for non-standart panel sizes

**ECO** 1591.0100



Installation Area 安裝尺寸(範圍)			Back Area 背部安裝		Installation Depth 安裝深度		Support Arm No TK 連接管型號		Order No 訂貨號
Width (mm)	Height (mm)	Depth (mm)	Hinge 後開門型式	Screw 固定背板 型式	H profil profile instal- lation platform 側面安裝平臺	Installation Deep (mm) 安裝深度	130mm Ø	118x65.5mm □	Eco
300	300	240	Yes	-	Yes	217	Yes	-	1591-0104
300	300	240	-	Yes	-	240	Yes	-	1591-0105
300	400	240	Yes	-	Yes	217	Yes	-	1591-0106
300	400	240	-	Yes	-	240	Yes	-	1591-0107
400	400	240	Yes	-	Yes	217	Yes	-	1591-0108
400	400	240	-	Yes	-	240	Yes	-	1591-0109
400	500	240	Yes	-	Yes	217	Yes	-	1591-0110
400	500	240	-	Yes	-	240	Yes	-	1591-0111
500	500	240	Yes	-	Yes	217	Yes	-	1591-0112
500	500	240	-	Yes	-	240	Yes	-	1591-0113
500	600	240	Yes	-	Yes	217	Yes	-	1591-0114
500	600	240	-	Yes	-	240	Yes	-	1591-0115
600	600	240	Yes	-	Yes	217	Yes	-	1591-0116
600	600	240	-	Yes	-	240	Yes	-	1591-0117

\*\* Please contact with us for non-standart panel sizes

**ECO** 1591.1200



Installation Area 安裝尺寸(範圍)			Back Area 背部安裝		Installation Depth 安裝深度		Support Arm No TK 連接管型號		Order No 訂貨號
Width (mm)	Height (mm)	Depth (mm)	Hinge 後開門型式	Screw 固定背板 型式	H profil profile instal- lation platform 側面安裝平臺	Installation Deep (mm) 安裝深度	130mm Ø	118x65.5mm □	Eco
300	300	240	Yes	-	Yes	127	Yes	-	1591-1204
300	300	240	-	Yes	-	150	Yes	-	1591-1205
300	400	240	Yes	-	Yes	127	Yes	-	1591-1206
300	400	240	-	Yes	-	150	Yes	-	1591-1207
400	400	240	Yes	-	Yes	127	Yes	-	1591-1208
400	400	240	-	Yes	-	150	Yes	-	1591-1209
400	500	240	Yes	-	Yes	127	Yes	-	1591-1210
400	500	240	-	Yes	-	150	Yes	-	1591-1211
500	500	240	Yes	-	Yes	127	Yes	-	1591-1212
500	500	240	-	Yes	-	150	Yes	-	1591-1213
500	600	240	Yes	-	Yes	127	Yes	-	1591-1214
500	600	240	-	Yes	-	150	Yes	-	1591-1215
600	600	240	Yes	-	Yes	127	Yes	-	1591-1216
600	600	240	-	Yes	-	150	Yes	-	1591-1217

\*Please contact with us for keyboard dimensions

PANEL WALL MOUNTING APPLICATION

SEPERATOR (NEW)

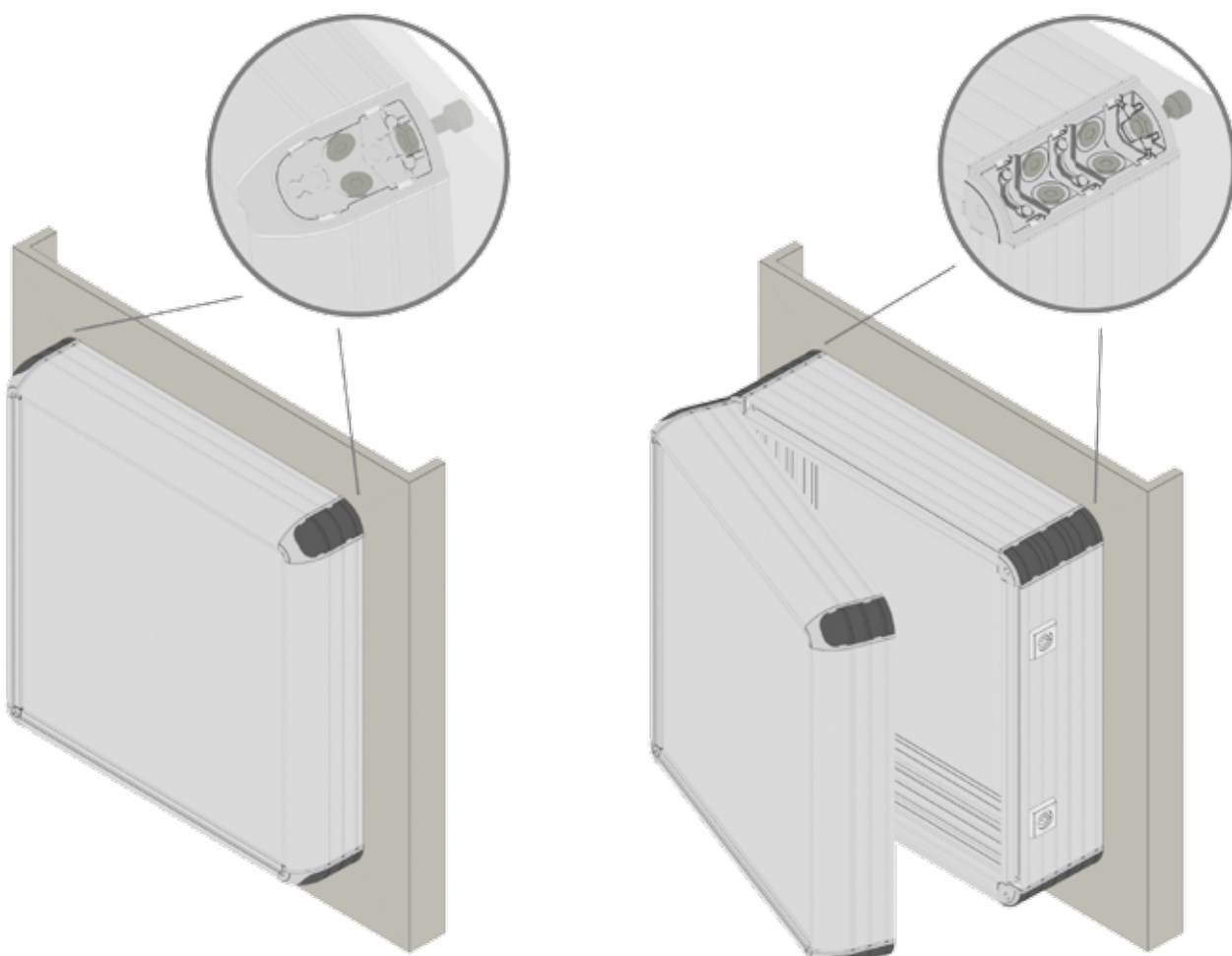
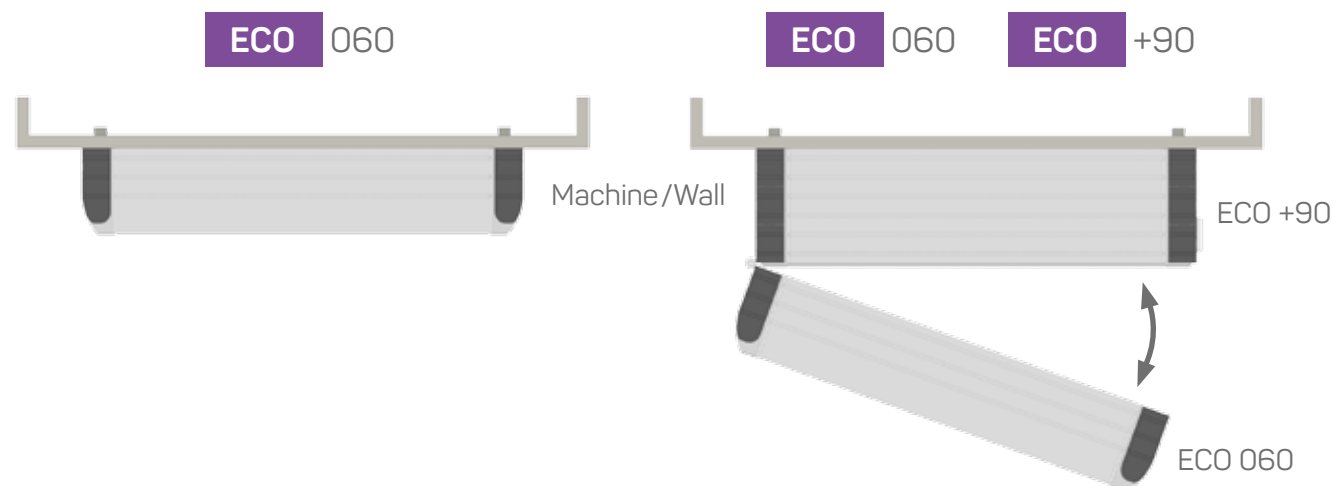

Wall application examples for **ECO 060** series panel  
Please contact us to find out the feasibility of the products.

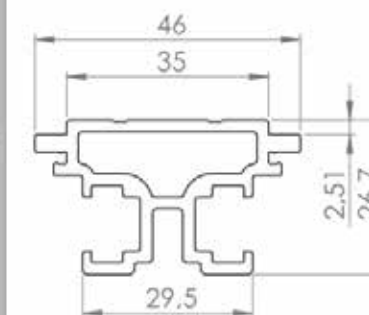
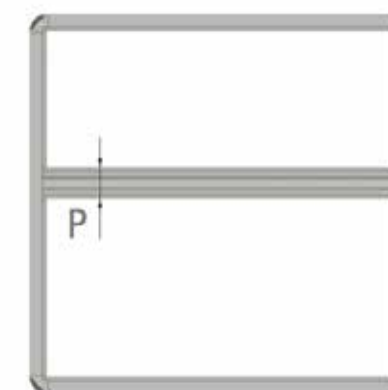

P= 46mm Front Face 35mm





TKP 2000 SERIES PANEL

TKP 2000 SERIES PANEL

**TKP 2000** Without Handle Back Plate With Double Hinged and Double Key Lock



Installation Area 安裝尺寸(範圍)			Back Area 背部安裝	Installation Depth 安裝深度		Support Arm No TK 連接管型號	Order No 訂貨號
Width (mm)	Height (mm)	Depth (mm)	Hinge 後開門型式	H profil profile instal- lation platform 側面安裝平臺	Installation Deep (mm) 安裝深度	130mm Ø	TKP
300	300	152	Yes	Yes	129	Yes	3030-0000
300	400	152	Yes	Yes	129	Yes	3040-0000
400	400	152	Yes	Yes	129	Yes	4040-0000
400	500	152	Yes	Yes	129	Yes	4050-0000
500	500	152	Yes	Yes	129	Yes	5050-0000
500	600	152	Yes	Yes	129	Yes	5060-0000
600	600	152	Yes	Yes	129	Yes	6060-0000

\*\* Please contact with us for non-standart panel sizes

**TKP 2000** Double Handle On Both Sides Back Plate With Double Hinged and Double Key Lock



Installation Area 安裝尺寸(範圍)			Back Area 背部安裝	Installation Depth 安裝深度		Support Arm No TK 連接管型號	Order No 訂貨號
Width (mm)	Height (mm)	Depth (mm)	Hinge 後開門型式	H profil profile instal- lation platform 側面安裝平臺	Installation Deep (mm) 安裝深度	130mm Ø	TKP
300	300	152	Yes	Yes	129	Yes	3030-4000
300	400	152	Yes	Yes	129	Yes	3040-4000
400	400	152	Yes	Yes	129	Yes	4040-4000
400	500	152	Yes	Yes	129	Yes	4050-4000
500	500	152	Yes	Yes	129	Yes	5050-4000
500	600	152	Yes	Yes	129	Yes	5060-4000
600	600	152	Yes	Yes	129	Yes	6060-4000

\*\* Please contact with us for non-standart panel sizes

**TKP 2000** One Handle From Bottom Back Plate With Double Hinged and Double Key Lock



Installation Area 安裝尺寸(範圍)			Back Area 背部安裝	Installation Depth 安裝深度		Support Arm No TK 連接管型號	Order No 訂貨號
Width (mm)	Height (mm)	Depth (mm)	Hinge 後開門型式	H profil profile instal- lation platform 側面安裝平臺	Installation Deep (mm) 安裝深度	130mm Ø	TKP
300	300	152	Yes	Yes	129	Yes	3030-2000
300	400	152	Yes	Yes	129	Yes	3040-2000
400	400	152	Yes	Yes	129	Yes	4040-2000
400	500	152	Yes	Yes	129	Yes	4050-2000
500	500	152	Yes	Yes	129	Yes	5050-2000
500	600	152	Yes	Yes	129	Yes	5060-2000
600	600	152	Yes	Yes	129	Yes	6060-2000

\*\* Please contact with us for non-standart panel sizes



Elegant, high grade look,  
attractive design.

**TKP 2000 Series**

LM Construction with surrounding silicone seal , anodised extruder aluminium profiles and aluminium die-cast corner components for fast and efficient controller heat transfer. Several installation area dimensions, minimum 250x250 mm, maximum 600x600 mm (widthxlength) and 152 mm mounting depth. Customizable by coloured eloxal basic profiles, coloured corner elements and coloured front plates. Suitable for all TEKNOKOL arm systems. Equipped with standart hinged back plate and double key lock. Enclosure color; naturally anodized E6/CO. Corner elements; RAL 7016 anthracite-gray. Protection class; IP 65/ IEC 60 529

FRONT SHEET INSTALLATION

BACK PLATE MOUNTING CONFIGURATIONS

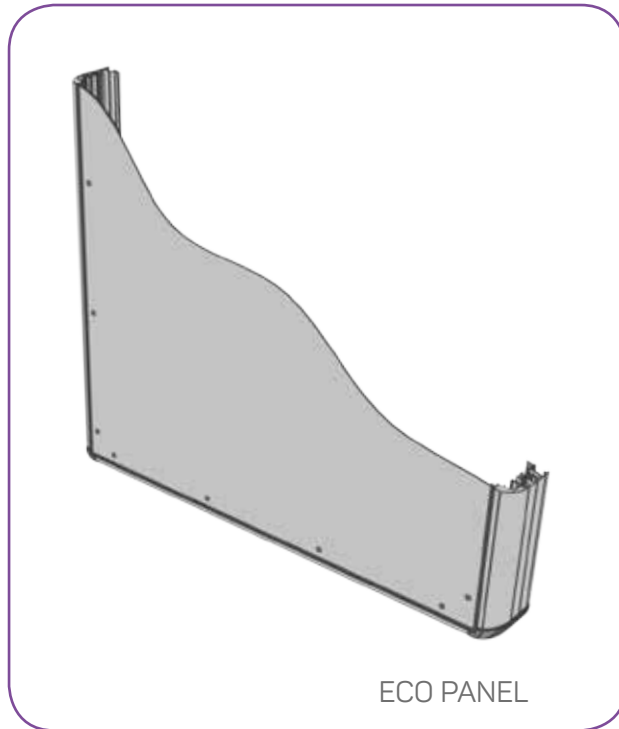

ECO PANEL

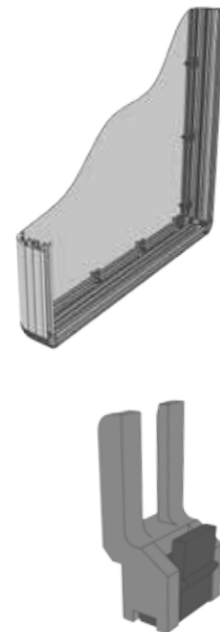

Zamak Alloys  
Connector

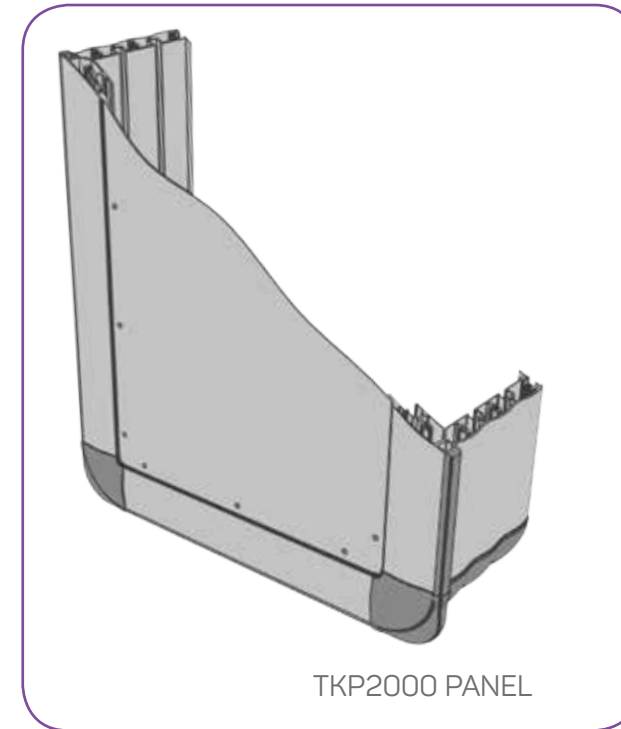

TKP2000 PANEL

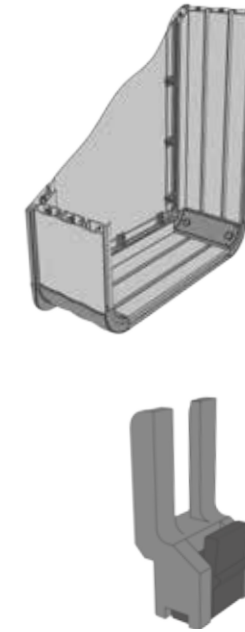

Zamak Alloys  
Connector

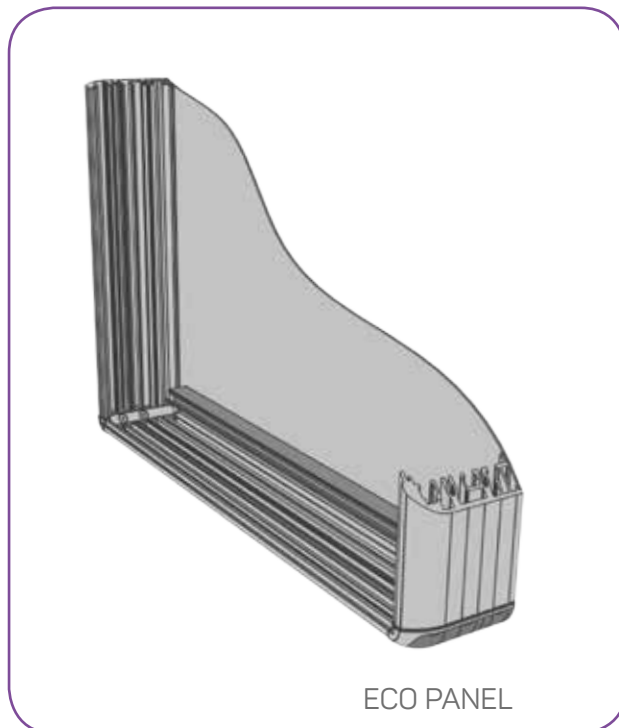

ECO PANEL

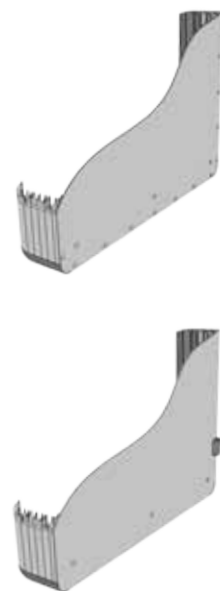

Panel Back  
Plate Fixed  
(Screw)

Panel Back  
Plate Moveable  
(Hinge)

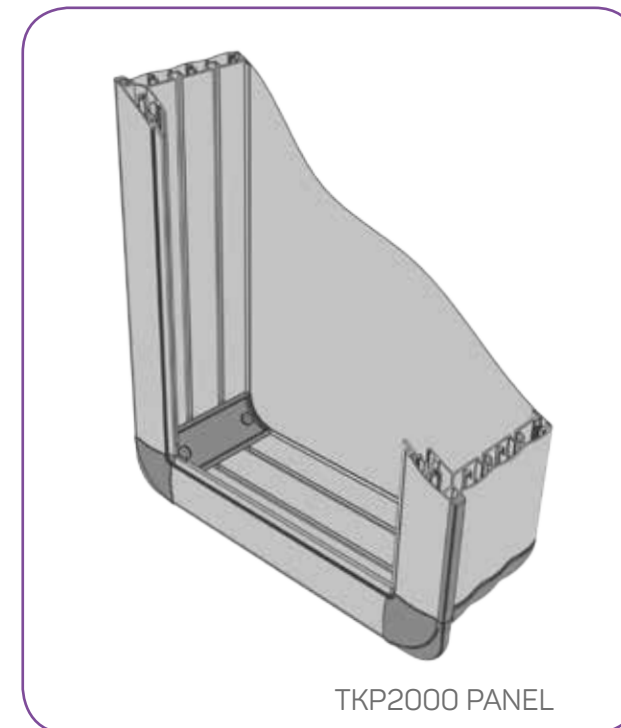

TKP2000 PANEL

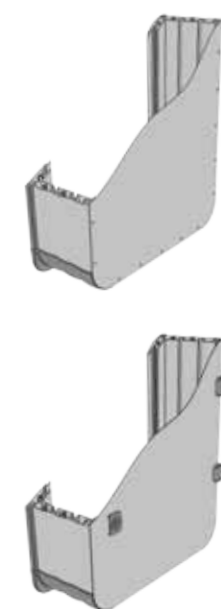

Panel Back  
Plate Fixed  
(Screw)

Panel Back  
Plate Moveable  
(Hinge)





# Kiosk Systems



060 SERIES STAND SYSTEMS

120 SERIES STAND SYSTEMS

**KS.060.01** Fixed Kiosk Plate



Weight (gr)	16.500
Color/Ral No	7035
Package	1
Package Dimension (mm)	510x610x110
Movement	Fixed

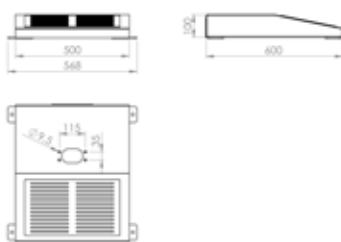

**KS.120.01** Fixed Kiosk Plate



Weight (gr)	16.500
Color/Ral No	7035
Package	1
Package Dimension (mm)	510x610x110
Movement	Fixed

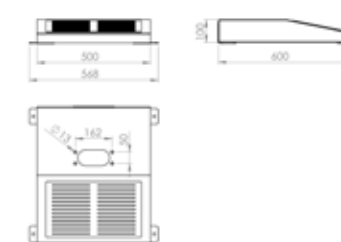

**KS.060.02** Moduler Kiosk Plate



Weight (gr)	16.500
Color/Ral No	7035
Package	1
Package Dimension (mm)	510x610x110
Movement	Modular

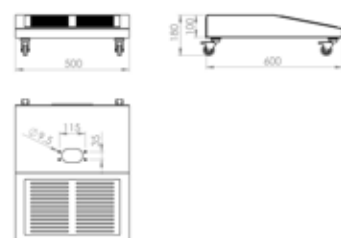

**KS.120.02** Moduler Kiosk Plate



Weight (gr)	16.500
Color/Ral No	7035
Package	1
Package Dimension (mm)	510x610x110
Movement	Modular

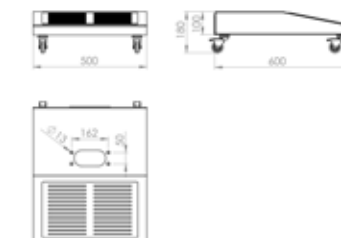

**KS.060.03** Fixed Kiosk Plate



Weight (gr)	16.500
Color/Ral No	7035
Package	1
Package Dimension (mm)	510x610x110
Movement	Fixed

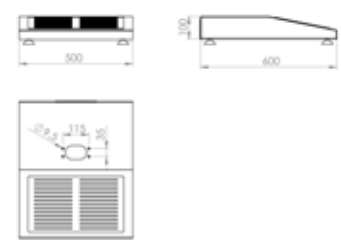

**KS.120.03** Fixed Kiosk Plate



Weight (gr)	16.500
Color/Ral No	7035
Package	1
Package Dimension (mm)	510x610x110
Movement	Fixed

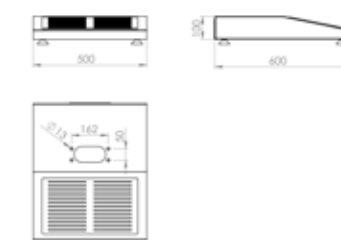

This product group only compatible with TK060.800

This product group only compatible with TK120.800

STAND SYSTEMS

STAND SYSTEMS



**KS.KABIN.01**

Kiosk Enclosure Systems

Color/Ral No	7035 / 7016
Package	1
Package Dimension (mm)	620 x 1220 x 620
Movement	Modular



**KS.KABIN.03**

Kiosk Enclosure Systems

Color/Ral No	7035 / 7016
Package	1
Package Dimension (mm)	620 x 1220 x 620
Movement	Modular



**KS.KABIN.02**

Kiosk Enclosure Systems

Color/Ral No	7035 / 7016
Package	1
Package Dimension (mm)	620 x 1220 x 620
Movement	Modular



**KS.KABIN.04**

Kiosk Enclosure Systems

Color/Ral No	7035 / 7016
Package	1
Package Dimension (mm)	620 x 1220 x 620
Movement	Modular



\*Sample applications designed for customers.  
Please contact with us for dimension.

\*Sample applications designed for customers.  
Please contact with us for dimension.



STAND SYSTEMS

STAND SYSTEMS



**KS.PC.01**

Kiosk Enclosure Systems

Color/Ral No	7035 / 7016
Package	1
Package Dimension (mm)	1000x950x700
Movement	Modular



**KS.PC.03**

Kiosk Enclosure Systems

Color/Ral No	7035 / 7016
Package	1
Package Dimension (mm)	1000x950x700
Movement	Modular



**KS.PC.02**

Kiosk Enclosure Systems

Color/Ral No	7035 / 7016
Package	1
Package Dimension (mm)	1000x950x700
Movement	Modular



**KS.PC.04**

Kiosk Enclosure Systems

Color/Ral No	7035 / 7016
Package	1
Package Dimension (mm)	1000x950x700
Movement	Modular



\*Sample applications designed for customers.  
Please contact with us for dimension.

\*Sample applications designed for customers.  
Please contact with us for dimension.

STAND SYSTEMS

STAND SYSTEMS



**KS.STAND.060.01**

Stand Systems

Color/Ral No	RAL7035
Package	1
Movement	Portable



**KS.STAND.120.01**

Stand Systems

Color/Ral No	RAL7035
Package	1
Movement	Portable



**KS.STAND.060.02**

Stand Systems

Color/Ral No	RAL7035
Package	1
Movement	Portable

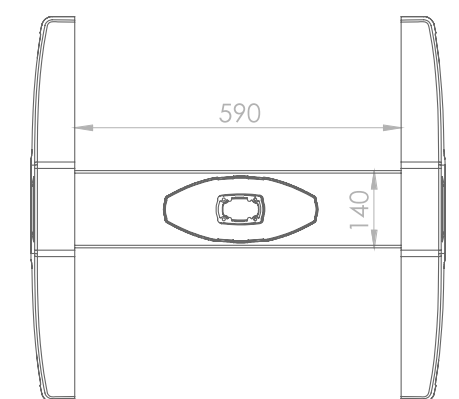
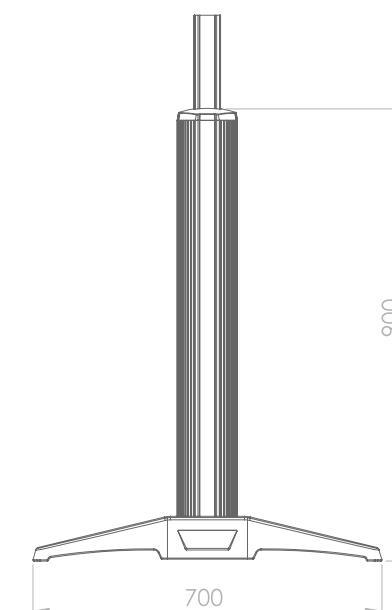
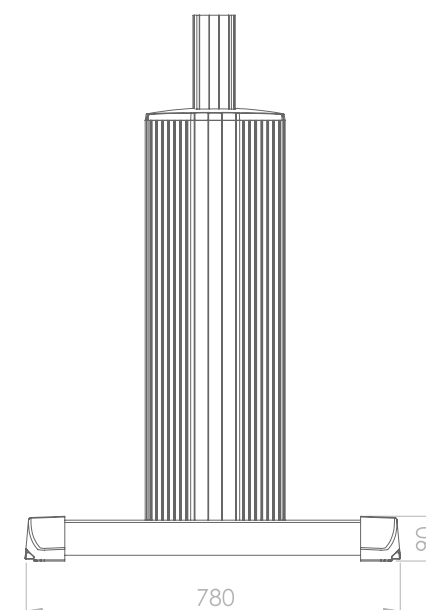

\*Sample applications designed for customers.  
Please contact with us for dimension.

\*Sample applications designed for customers.  
Please contact with us for dimension.

COUPLING TOWERS 立柱



**Coupling  
Towers**  
立柱懸臂座



■ Coupling Towers

	TK140.200	TK140.250	TK140.300
Weight(kg)	45	55	65
Length(mm)	2000	2500	3000
Ral / Color No	7035	7035	7035
Package	1	1	1
Package Dimension (mm)	240x2000	240x2500	240x3000
Movement	Fixed	Fixed	Fixed

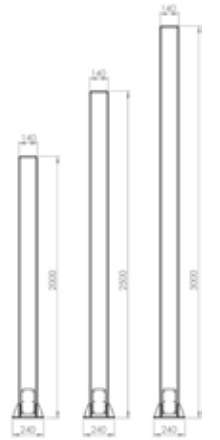

■ Coupling Towers

	TK200.200	TK200.250	TK200.300
Weight(kg)	70	85	100
Length(mm)	2000	2500	3000
Ral / Color No	7035	7035	7035
Package	1	1	1
Package Dimension (mm)	400x2000	400x2500	400x3000
Movement	Fixed	Fixed	Fixed

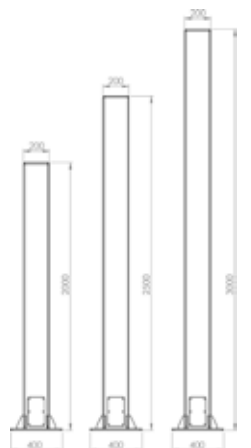



WARNING LAMPS



Warning Lamps



**IKZ.01**

Warning Lamps

- One block with color options
- 22 mm coupling nut
- LED or Flasher LED option (on same block)
- 90 db buzzer
- 24 V dc

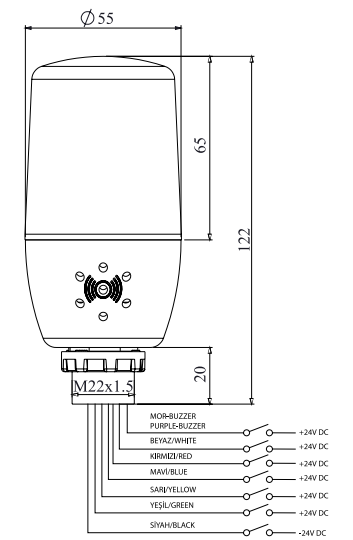

**IKZ.02**

Warning Lamps

- 3 level, 3 color option
- 22 mm coupling nut
- LED or Flasher LED option (on same block)
- 90 db buzzer
- 24 V dc

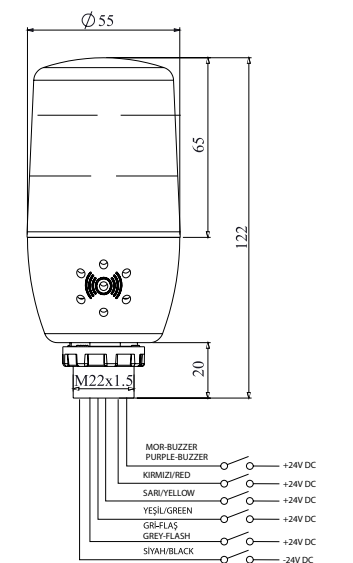

# JABEZ

雅比斯國際有限公司

Support Arm and Control Panel Systems





